

User's Manual

RadiForce® GS310-BL GS310-CL GS310-CLG

Monochrome LCD Monitor

It shall be assured that the final system is in compliance to IEC60601-1-1 requirements.



SAFETY SYMBOLS

This manual uses the safety symbols below. They denote critical information. Please read them carefully.



WARNING

Failure to abide by the information in a WARNING may result in serious injury and can be life threatening.



CAUTION

Failure to abide by the information in a CAUTION may result in moderate injury and/or property or product damage.



Indicates a prohibited action.



Indicates to ground for safety.

- Power supplied equipment can emit electromagnetic waves, that could influence, limit or result in malfunction of the monitor. Install the equipment in a controlled environment, where such effects are avoided.
- This is a monitor intended for use in a medical image system.
- Product specifications may vary depending on the region. Confirm the specifications in the manual written in the language of the region of purchase.

Copyright© 2006 EIZO NANA O CORPORATION All rights reserved. No part of this manual may be reproduced, stored in a retrieval system, or transmitted, in any form or by any means, electronic, mechanical, or otherwise, without the prior written permission of EIZO NANA O CORPORATION.

EIZO NANA O CORPORATION is under no obligation to hold any submitted material or information confidential unless prior arrangements are made pursuant to EIZO NANA O CORPORATION's receipt of said information. Although every effort has been made to ensure that this manual provides up-to-date information, please note that EIZO monitor specifications are subject to change without notice.

Apple and Macintosh are registered trademarks of Apple Computer, Inc.
VGA is a registered trademark of International Business Machines Corporation.
DPMS is a trademark and VESA is a registered trademark of Video Electronics Standards Association.
Windows is a registered trademark of Microsoft Corporation.
PowerManager, RadiCS and RadiNET are trademarks of EIZO NANA O CORPORATION.
ScreenManager, RadiForce and EIZO are registered trademarks of EIZO NANA O CORPORATION in Japan and other countries.

TABLE OF CONTENTS



PRECAUTIONS	4
1. INTRODUCTION	9
1-1. Features	9
1-2. Package Contents.....	9
1-3. Controls & Connectors	10
2. CABLE CONNECTIONS	12
2-1. Before Connecting	12
2-2. Cable Connection	12
3. MENUS & FUNCTIONS	15
3-1. ScreenManager	15
3-2. CAL Switch Function.....	17
3-3. Other Useful Functions	18
4. ADJUSTMENTS & SETTINGS	21
4-1. Brightness Adjustment	21
4-2. Image Adjustments	21
4-3. Power-save Setup.....	21
5. MAKING USE OF USB (Universal Serial Bus)	23
6. ATTACHING AN ARM	25
7. TROUBLESHOOTING	26
8. CLEANING	29
9. SPECIFICATIONS	30
10. GLOSSARY	33

PRECAUTIONS







IMPORTANT!

- This product has been adjusted specifically for use in the region to which it was originally shipped. If operated outside the region to which it was originally shipped, the product may not perform as stated in the specifications.
- To ensure personal safety and proper maintenance, please read this section and the caution statements on the unit (refer to the figure below).

[Location of the Caution Statements]



[Symbols on the unit]

Symbol	Location	This symbol indicates
	Side	Main power switch Press to turn the monitor's main power off.
	Side	Main power switch Press to turn the monitor's main power on.
	Front Control panel	Power button Press to turn the monitor's power on or off.
	Rear Name Plate	Alternating current
	Rear	Alerting electrical hazard
	Rear	Caution Refer to SAFETY SYMBOLS section in this manual.

WARNING

If the unit begins to emit smoke, smells like something is burning, or makes strange noises, disconnect all power connections immediately and contact your dealer for advice.

Attempting to use a malfunctioning unit may result in fire, electric shock, or equipment damage.

Do not open the cabinet or modify the unit.

Opening the cabinet or modifying the unit may result in fire, electric shock, or burn.



Refer all servicing to qualified service personnel.

Do not attempt to service this product yourself as opening or removing covers may result in fire, electric shock, or equipment damage.

Keep small objects or liquids away from the unit.

Small objects accidentally falling through the ventilation slots into the cabinet or spillage into the cabinet may result in fire, electric shock, or equipment damage.

If an object or liquid falls/spills into the cabinet, unplug the unit immediately. Have the unit checked by a qualified service engineer before using it again.

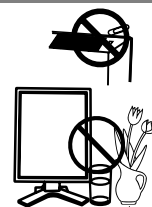

Place the unit at the strong and stable place.

A unit placed on an inadequate surface may fall and result in injury or equipment damage.

If the unit falls, disconnect the power immediately and ask your dealer for advice. Do not continue using a damaged unit. Using a damaged unit may result in fire or electric shock.



Set the unit in an appropriate location.

Not doing so may result in fire, electric shock, or equipment damage.

- * Do not place outdoors.
- * Do not place in the transportation system (ship, aircraft, trains, automobiles, etc.)
- * Do not place in a dusty or humid environment.
- * Do not place in a location where the steam comes directly on the screen.
- * Do not place near heat generating devices or a humidifier.
- * Do not place in an inflammable gas environment.



To avoid danger of suffocation, keep the plastic packing bags away from babies and children.



Use the enclosed power cord and connect to the standard power outlet of your country.

Be sure to remain within the rated voltage of the power cord.

Not doing so may result in fire or electric shock.

WARNING

To disconnect the power cord, grasp the plug firmly and pull.

Tugging on the cord may damage and result in fire or electric shock.



The equipment must be connected to a grounded main outlet.

Not doing so may result in fire or electric shock.



Use the correct voltage.

- * The unit is designed for use with a specific voltage only. Connection to another voltage than specified in this User's Manual may cause fire, electric shock, or equipment damage.
- * Do not overload your power circuit, as this may result in fire or electric shock.

Handle the power cord with care.

- * Do not place the cord underneath the unit or other heavy objects.
- * Do not pull on or tie the cord.

If the power cord becomes damaged, stop using it. Use of a damaged cord may result in fire or electric shock.

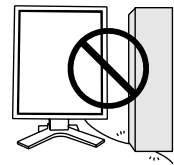

Never touch the plug and power cord if it begins to thunder.

Touching them may result in electric shock.

When attaching an arm stand, please refer to the user's manual of the arm stand and install the unit securely with the enclosed screws.

Not doing so may cause the unit to come unattached, which may result in injury or equipment damage. When the unit is dropped, please ask your dealer for advice. Do not continue using a damaged unit. Using a damaged unit may result in fire or electric shock. When reattaching the tilt stand, please use the same screws and tighten them securely.

WARNING

Do not touch a damaged LCD panel directly with bare hands.

The liquid crystal which leaks from the panel is poisonous if it enters the eyes or mouth.

If any part of the skin or body comes in direct contact with the panel, please wash thoroughly. If some physical symptoms result, please consult your doctor.



Follow local regulation or laws for safe disposal.

The backlight of the LCD panel contains mercury.

CAUTION

Handle with care when carrying the unit.

Disconnect the power cord and cables when moving the unit. Moving the unit with the cord attached is dangerous. It may result in injury.

When handling the unit, grip the bottom of the unit firmly with both hands ensuring the panel faces outward before lifting.

Dropping the unit may result in injury or equipment damage.



Do not block the ventilation slots on the cabinet.

- * Do not place any objects on the ventilation slots.
- * Do not install the unit in a closed space.
- * Do not use the unit laid down or upside down.

Blocking the ventilation slots prevents proper airflow and may result in fire, electric shock, or equipment damage.



Do not touch the plug with wet hands.

Doing so may result in electrical shock.



Use an easily accessible power outlet.

This will ensure that you can disconnect the power quickly in case of a problem.

Periodically clean the area around the plug.

Dust, water, or oil on the plug may result in fire.

Unplug the unit before cleaning it.

Cleaning the unit while it is plugged into a power outlet may result in electric shock.

If you plan to leave the unit unused for an extended period, disconnect the power cord from the wall socket after turning off the power switch for the safety and the power conservation.

LCD Panel

The screen may have defective pixels. These pixels may appear as slightly light or dark area on the screen. This is due to the characteristics of the panel itself, and not the product.

The backlight of the LCD panel has a fixed life span. When the screen becomes dark or begins to flicker, please contact your dealer.

Do not press on the panel or edge of the frame strongly, as this may result in damage to the screen. There will be prints left on the screen if the pressed image is dark or black. If pressure is repeatedly applied to the screen, it may deteriorate or damage your LCD panel. Leave the screen white to decrease the prints.

Do not scratch or press on the panel with any sharp objects, such as a pencil or pen as this may result in damage to the panel. Do not attempt to brush with tissues as this may scratch the LCD panel.

When the screen image is changed after displaying the same image for extended periods of time, an afterimage may appear. Use the screen saver or timer to avoid displaying the same image for extended periods of time.

When the monitor is cold and brought into a room or the room temperature goes up quickly, dew condensation may occur inside and outside the monitor. In that case, do not turn the monitor on and wait until dew condensation disappears, otherwise it may cause some damages to it.

1. INTRODUCTION

Thank you for choosing an EIZO Monochrome Monitor.

1-1. Features

- DVI Digital input compliant (see p.33 ; for TMDS, see p.33)
- [Horizontal scanning frequency] 31 - 100 kHz
 [Vertical scanning frequency] 48 ~ 71.5 Hz (VGA text: 69 - 71 Hz)
 [Resolution] 3M pixels (Portrait: 1536 × 2048 dots (H × V))
 [Frame synchronous mode] 59 - 61 Hz supported
- Cal Switch function for selecting an optimal calibration mode (see p.17)
- Selectable screen compliant with DICOM Part 14 (see p.33)
- USB (Universal Serial Bus) hub support (see p. 23)
- Utility software “ScreenManager Pro for Medical”, which enables control of the monitor from a Windows PC with a mouse or keyboard (refer to the EIZO LCD Utility Disk).
- Monitor stand adjustable for different heights
- Ultra slim bezel
- 12bit monochrome signal input support^{*1}

^{*1} Before a 12bit monochrome signal can be input, your graphics board must be configured. For details, refer to the user's manual for the graphics board.

1-2. Package Contents

Please contact your local dealer for assistance if any of the listed items are missing or damaged.

- | | |
|-----------------------------|--|
| • LCD Monitor ^{*1} | • EIZO LCD Utility Disk |
| • Power Cord | • User's Manual |
| • Signal Cable (FD-C39) | • LIMITED WARRANTY |
| • EIZO USB Cable (MD-C93) | • Cleaning Kit “ScreenCleaner”
(GS310-CLG only) |

^{*1} The landscape position is the default monitor orientation. For the portrait position, rotate the monitor ninety degrees counter-clockwise before installing it.

NOTE

- Please retain the packing materials for future transport of the monitor.

1-3. Controls & Connectors

Front

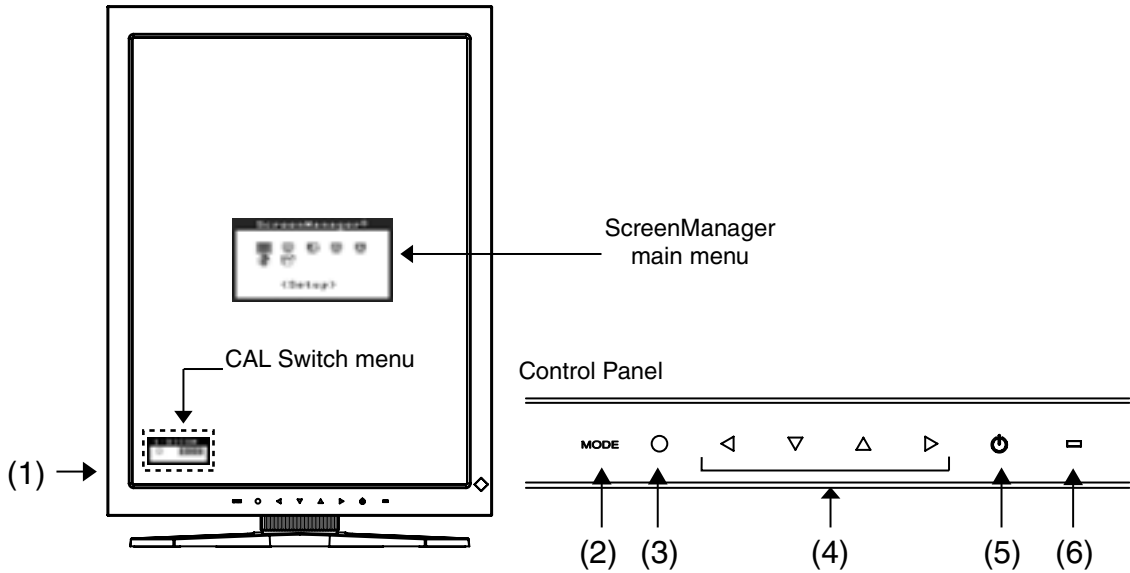

- (1) Main Power Switch
- (2) **MODE** Mode Switch
- (3) **ENTER** Enter Switch
- (4) Directing Switches (Left, Down, Up, Right)¹
- (5) Power Switch
- (6) Power Indicator²

Green	Operational
Orange	Power saving
Flashing orange slowly	Power off (Main power is on)
Off	Main Power off



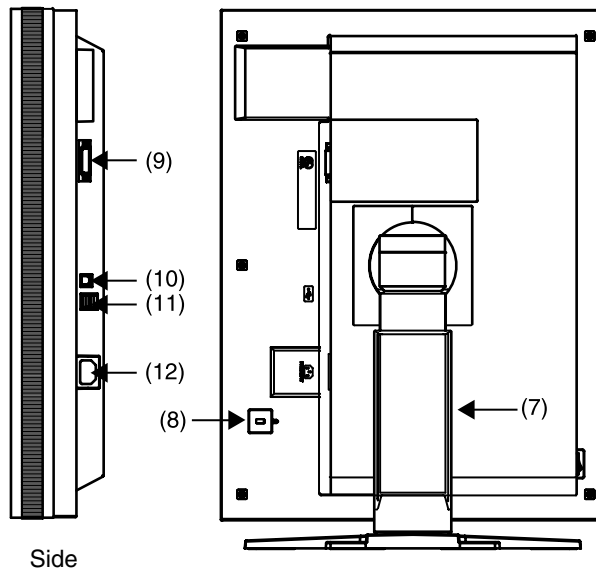

¹ When the monitor is oriented in the landscape position, these switches can be changed to Up, Left, Right, and Down.

² To disable the power indicator while the monitor is operational, see page 19. For power indicator status when using the “Off Timer,” see page 20.

Side / Rear



(7) Monitor stand with adjustable height (detachable)³

- (8)  Security lock slot⁴
- (9)  DVI-D input connector
- (10)  USB upstream port (x 1)
- (11)  USB downstream ports (x 2)
- (12)  Power connector

³ The LCD monitor can be oriented in the landscape position. (It can rotate clockwise ninety degrees.)

By removing the monitor stand, the LCD monitor can be used with the optional arm stand (see p. 25).

⁴ Allows for connection of a security cable. This lock supports Kensington's MicroSaver security system. For further information, please consult

Kensington Technology Group
 2855 Campus Drive, San Mateo, CA 94403 USA
 Tel.: 800-650-4242, x3348, Intl: 650-572-2700, x3348
 Fax: 650-572-9675
<http://www.kensington.com>

2. CABLE CONNECTIONS

2-1. Before Connecting

Before connecting your monitor to the PC, change the display screen settings resolution (see p.33) and frequency in accordance with the charts below.

NOTE

- When your computer and display support VESA DDC, the appropriate resolution and the refresh rate are set just by plugging your display into the computer without any manual settings.

Resolution		Frequency	Dot Clock	Display mode	
				Portrait	Landscape
720×400	VGA TEXT	70 Hz	165 MHz (Max.)	√	√
640×480	VGA	60 Hz		√	√
1536×1024	3M Packed Pixel	60 Hz		√	–
1024×1536	3M Packed Pixel	60 Hz		–	√

“√”: Supported

2-2. Cable Connection

NOTE

- Be sure that the power switches of both the PC and the monitor are OFF.
- Refer also to the PC user's manual when connecting the monitor.
- Before a 12bit monochrome signal can be input, your graphics board must be configured. For details, refer to the user's manual for the graphics board.

1. Rotate the monitor ninety degrees counter-clockwise into the portrait position.

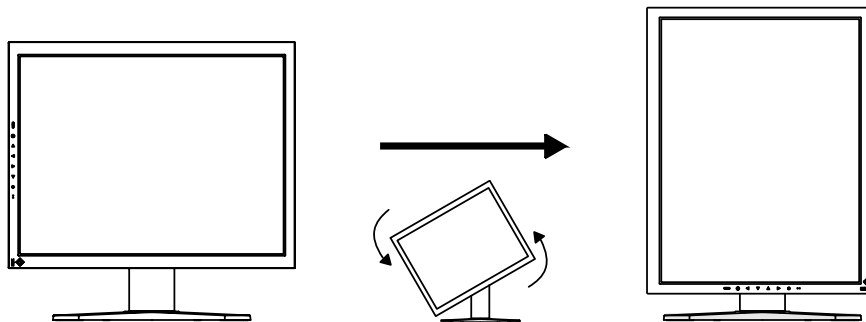

2. Connect the signal cable to the DVI-D input connector on the rear of the monitor and to the video output connector on the PC.

After connecting, secure the cable connectors with the attached screw-in fasteners.

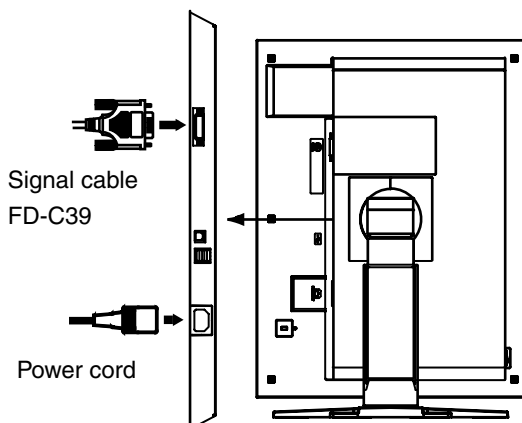

Signal Cable	Connector	PC
Signal cable (FD-C39) 	Video output connector / DVI	Exclusive graphics board (See p.31)

3. Connect the power cord to the power connector on the rear of the monitor.

4. Thread the power cord and signal cable through the cable holder on the rear of the monitor stand.

NOTE

- When threading the cables through the cable holder, lead them to the cable entrance side and pinch the projection to open the cable entrance.
- It is recommended that some slack be left in the cables to allow for smooth adjustment of the monitor stand and easy rotation between the portrait and landscape positions.

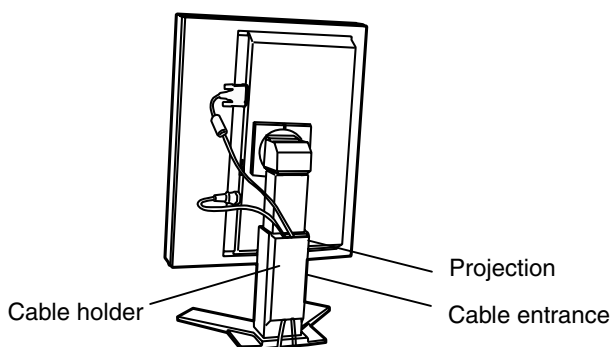

5. Connect the other end of the power cord to a power outlet.

 **WARNING**

Use the enclosed power cord and connect to the standard power outlet of your country.

Be sure to remain within the rated voltage of the power cord.

Not doing so may result in fire or electric shock.

The equipment must be connected to a grounded main outlet.

Not doing so may result in fire or electric shock.



6. Turn on the monitor's power by touching the power switch.

The monitor's power indicator will light up green.

7. Turn on the PC's power.

If an image does not appear, refer to "7. TROUBLESHOOTING" (see p. 26) for additional advice.

When finished, turn off the PC and the monitor.

NOTE

- Adjust the brightness of the screen depending on the brightness of your environment.
- Be sure to take adequate rests. A 10-minute rest period each hour is suggested.

8. When inputting a 12bit monochrome signal, change the input signal setting.

Change the settings in the ScreenManager <Signal Selection> menu. For more on changing the settings, refer to "Signal Selection" (see p. 18).

9. When using the software "ScreenManager Pro for Medical," connect the monitor to a USB compliant Windows computer (or other USB hub) with a USB cable.

Refer to "5. MAKING USE OF USB (Universal Serial Bus)" (see p. 23).

3. MENUS & FUNCTIONS

3-1. ScreenManager

Screen adjustments and settings can be performed with the monitor controls.

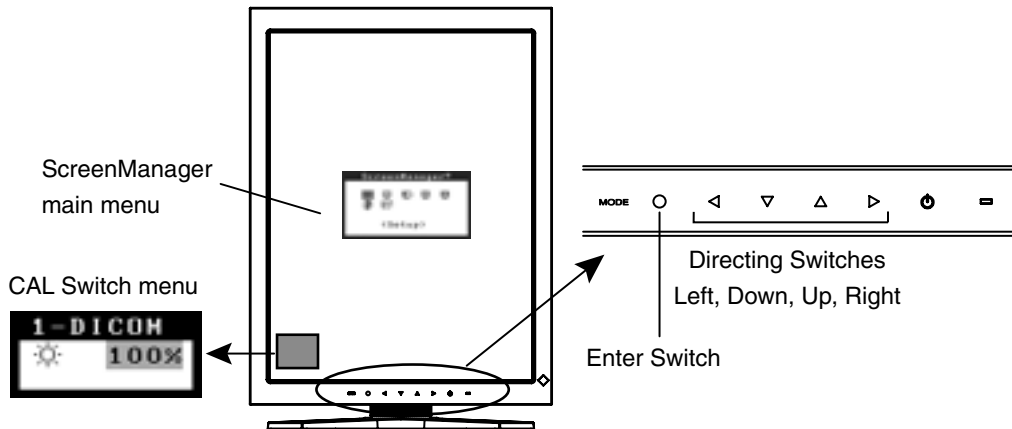

NOTE

- The ScreenManager menu and CAL Switch menu cannot be displayed at the same time.

How to use the ScreenManager

[Entering the ScreenManager]

- (1) Touch the enter switch.

[Making adjustments and settings]

- (1) Select the desired submenu icon with the directing switches and touch the enter switch.
- (2) Select the desired setting icon with the directing switches and touch the enter switch.
- (3) Make any required adjustments with the directing switches.

[Exiting the ScreenManager]

- (1) To return to the main menu, select the <Return> icon or touch the Down directing switch twice, followed by the enter switch.
- (2) To exit the ScreenManager, select the <Exit> icon or touch the Down directing switch twice, followed by the enter switch.

NOTE

- Touching the enter switch twice also exits the ScreenManager.

ScreenManager Menus and Settings.

The following table briefly explains each of the menus and settings in the ScreenManager.

Main menu	Sub menu		Explanation
Setup	Signal Selection		See 3-3. Other Useful Functions (p. 18)
	Mode Preset		
Mode	Brightness		See 4-1. Brightness Adjustment (p. 21)
	Reset		
PowerManager	DVI DMPM		See 4-3. Power-save Setup (p. 21)
Others	Border Intensity		See 4-2. Image Adjustments (p.21)
	Off Timer		Turn off the monitor after a specified time (see p. 20).
	Menu Settings	Menu Position	Adjust the menu position
		Menu Off Timer	Adjust how long to display the menu. ¹
	Power Indicator		Disable the green power indicator (see p.19).
Reset		Restore the factory default settings (see p. 31).	
Information	Information		View the ScreenManager settings, model name, serial number, and usage time ² .
Language	English, German, French, Spanish, Italian, Swedish and Japanese		Select the language of the ScreenManager menus.

¹ The display time of the CAL Switch menu can be adjusted.

² Due to factory inspection, the usage time may not be "0 hours" at time of shipping.

3-2. CAL Switch Function

This function allows you to select the optimal display mode for your display images and adjust the brightness in each mode.

CAL Switch Modes

Mode	Description
1-DICOM	Select this option to display images in the DICOM mode (see p. 33).
2-Native	Select this option to display images using the native characteristics of the monitor panel.
3-CAL	Used for monitor calibration

* All modes can be calibrated independently.
The mode name can also be changed using the calibration kit (see Optional, p. 31).

How to use the CAL Switch Function

[Entering the CAL Switch menu]

(1) Touch the mode switch.

"CAL Switch" mode →
Brightness →

"CAL Switch" menu



[Selecting the CAL Switch mode]

(1) Touch the mode switch while the CAL Switch menu is displayed.

[Making brightness adjustments in CAL Switch mode]

(1) Touch the mode switch.

(2) Adjust the brightness value with the Left and Right directing switches.

[Closing the CAL Switch menu]

(1) Touch the enter switch.

NOTE

- The ScreenManager menu and CAL Switch menu cannot be displayed at the same time.
- When switching between modes, the monitor can be set to display only the desired modes, skipping any unnecessary modes (see p.19).

3-3. Other Useful Functions

Hardware Rotation





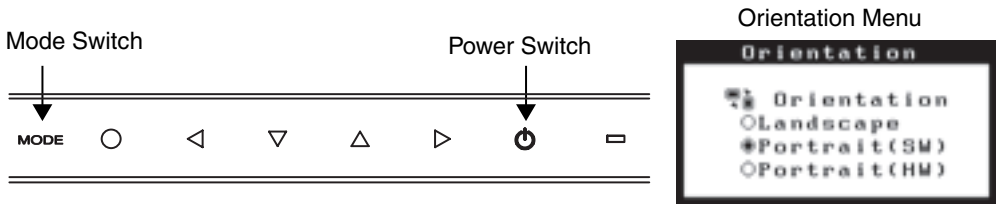

This function allows you to rotate the monitor image 90 degrees without using special software or graphics board utilities.

[How to set]

- (1) Shut down the computer if it is running. Also, turn off the monitor by touching the power switch on the control panel.
- (2) Turn off the monitor power.
- (3) Touch the power switch while touching the mode switch on the control panel. The <Orientation> menu appears.



- (4) Select the menu option according to your monitor orientation and touch the enter switch.

Menu Option	Monitor Orientation	Display Example
Landscape	Select this option when using the Landscape orientation.	  Landscape Portrait
Portrait (SW)	Select this option when using the Portrait orientation. The software is used to rotate the display image 90 degrees.	  Landscape Portrait
Portrait (HW)	Select this option when using the Portrait orientation. The monitor function is used to rotate the display image 90 degrees.	  Landscape Portrait

- (5) Change the monitor orientation and restart the computer.

Signal Selection

This monitor supports the input of a 12bit monochrome signal.

[How to set]

- (1) Select <Signal Selection> in the ScreenManager <Setup> menu.
- (2) Select the type of signal to input.

Mode Preset

When CAL Switch mode is selected, the computer can be forced to display only specified modes. Use this function when the display modes are restricted or when the display should not be changed needlessly.

[How to set]

- (1) Select <Mode Preset> in the ScreenManager <Setup> menu.
- (2) Set each mode to “On” or “Off”.

NOTE

- You cannot disable all modes. Set one or more modes to “On”.

[How to cancel]

- (1) Select <Mode Preset> in the ScreenManager <Setup> menu.
- (2) Set the mode that you wish to display to “On”.

Power Indicator

Use the function to keep the power indicator without light while the monitor is operational. (The power indicator is set by default to light when the power is turned on.)

[Procedure]

- (1) Select <Power Indicator> in the ScreenManager <Others> menu.
- (2) Select “Disable”.

Adjustment Lock

Use this function to prevent any accidental changes to the monitor settings. The following table shows which functions the adjustment lock affects.

Locked functions	<ul style="list-style-type: none"> • Display, adjustment, and setting of the ScreenManager • Brightness adjustments to the CAL Switch mode
Unlocked function	<ul style="list-style-type: none"> • Selection of the CAL Switch mode with the mode switch

[How to lock]

- (1) Turn off the monitor power by touching the power switch.
- (2) Touch the power switch while touching the enter switch.

[How to unlock]

- (1) Turn off the monitor power by touching the power switch.
- (2) Touch the power switch while touching the enter switch, and then turn on the monitor again. The adjustment lock is released, and the screen is displayed.

NOTE

- The adjustment lock function may activate when calibration is performed with the calibration kit (see Optional, p. 31). The monitor can be unlocked using the same unlocking procedure described above.

Off Timer

The off timer function causes the monitor to turn off automatically after a predetermined amount of time has lapsed. This function was created to reduce the afterimages particular to LCD monitors, which appear when the screen is left on for long periods without use.

[How to set]

- (1) Select <Off Timer> in the ScreenManager <Others> menu.
- (2) Select “Enable” and touch the Right and Left directing switches to adjust the “On Period” (1 to 23 hours).

[Off timer system]

PC	Monitor	Power Indicator
On Period (1H - 23H)	Operational	Green
Last 15 min. in “On period”	Advance Notice ^{*1}	Flashing green
“On period” expired	Power off	Flashing orange slowly

^{*1} By touching the power switch on the control panel during the Advance Notice period, the On Period can be reset to 90 minutes. Resetting can be performed an unlimited number of times.

[How to restore power]

- (1) Touch the power switch to return to a normal screen.

NOTE

- The off timer function works while the PowerManager is active, but there is no advance notice before the monitor's power is turned off.

4. ADJUSTMENTS & SETTINGS

4-1. Brightness Adjustment

The brightness of the entire screen can be set to a desired level.

[Procedure]

- (1) Select <Brightness> in the ScreenManager <Mode> menu.
- (2) Make adjustments with the Left and Right directing switches.
The Left directing switch makes the screen darker, and the Right directing switch makes it brighter.

NOTE

- Selecting <Reset> in the <Mode> menu resets the brightness of the selected CAL Switch mode to the factory default setting.

4-2. Image Adjustments

When a low-resolution image is displayed, the brightness of the border area surrounding the image (i.e., the dark area where no image appears) can be adjusted.

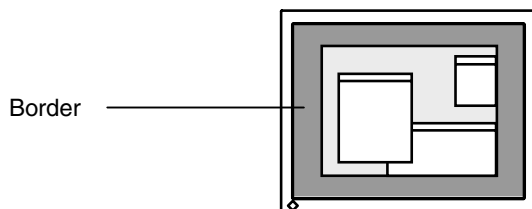

[Procedure]

- (1) Select <Border Intensity> in the ScreenManager <Others> menu.
- (2) Make adjustments with the Left and Right directing switches. The Left directing switch makes the border darker, and the Right directing switch makes it brighter.

4-3. Power-save Setup

Use the <PowerManager> menu in the ScreenManager to configure the power-save setup. This monitor complies with the “DVI DMPM” (see p. 33).

NOTE

- Do your part to conserve energy, turn off the monitor when you are finished using it. Disconnecting the monitor from the power supply is recommended to save energy completely.
- Even if the monitor is in power-saving mode, USB compliant devices draw power when they are connected to the monitor's USB ports (both upstream and downstream). Therefore, the monitor's power consumption will change according to which devices are connected, even if the monitor is in power-saving mode.

[Procedure]

- (1) Set the PC's power saving settings.
- (2) Select “DVI DMPM” in the <PowerManager> menu.

[Power saving system]

PC	Monitor	Power Indicator
On	Operation	Green
Power saving / Off mode	Power saving	Orange

[Power Resumption Procedure]

- Click the mouse or press a key on the keyboard to return to a normal screen.

5. MAKING USE OF USB (Universal Serial Bus)

This monitor provides a hub which supports the USB standard. When connecting to a USB compliant PC or another hub, the monitor functions as a hub to which the USB compliant peripherals can be easily connected.

Required system environment

- PC equipped with USB ports or another USB hub connected to the USB compliant PC
- Windows 98/2000/Me/XP // Mac OS 8.5.1 or later
- USB Cable (MD-C93)

NOTE

- The USB hub function may not work properly depending on the PC, OS or peripherals. Please consult the manufacturer of each device about the USB support.
- When the monitor is not on, the peripherals connected to the downstream ports will not operate.
- Even if the monitor is in a power saving mode, the devices connected to the monitor's USB ports (both the upstream and the downstream) will function.

Connecting to the USB HUB

1. Connect the monitor to the PC with the signal cable (see p.12) first, then turn on the PC.
2. Connect the upstream port of the monitor to the downstream port of the USB compliant PC or another hub by using the USB cable.

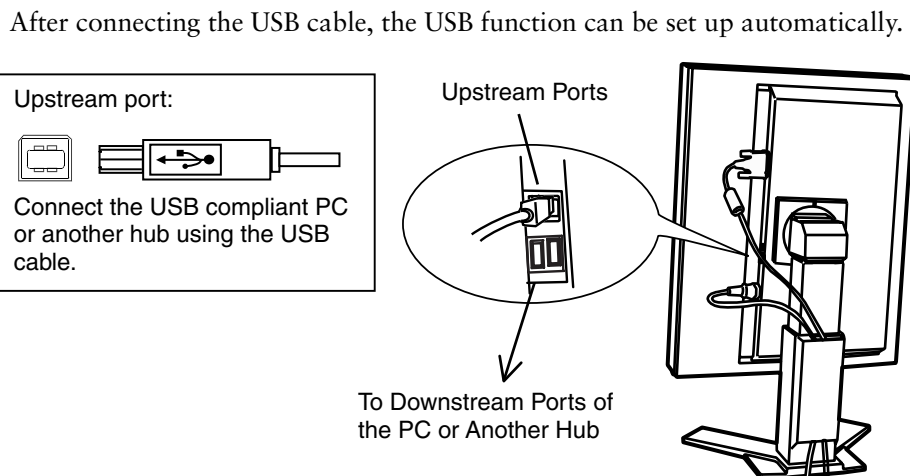

3. After setting up, the monitor's USB hub is available for connecting USB compliant peripherals to the downstream ports of the monitor.

Connecting Examples

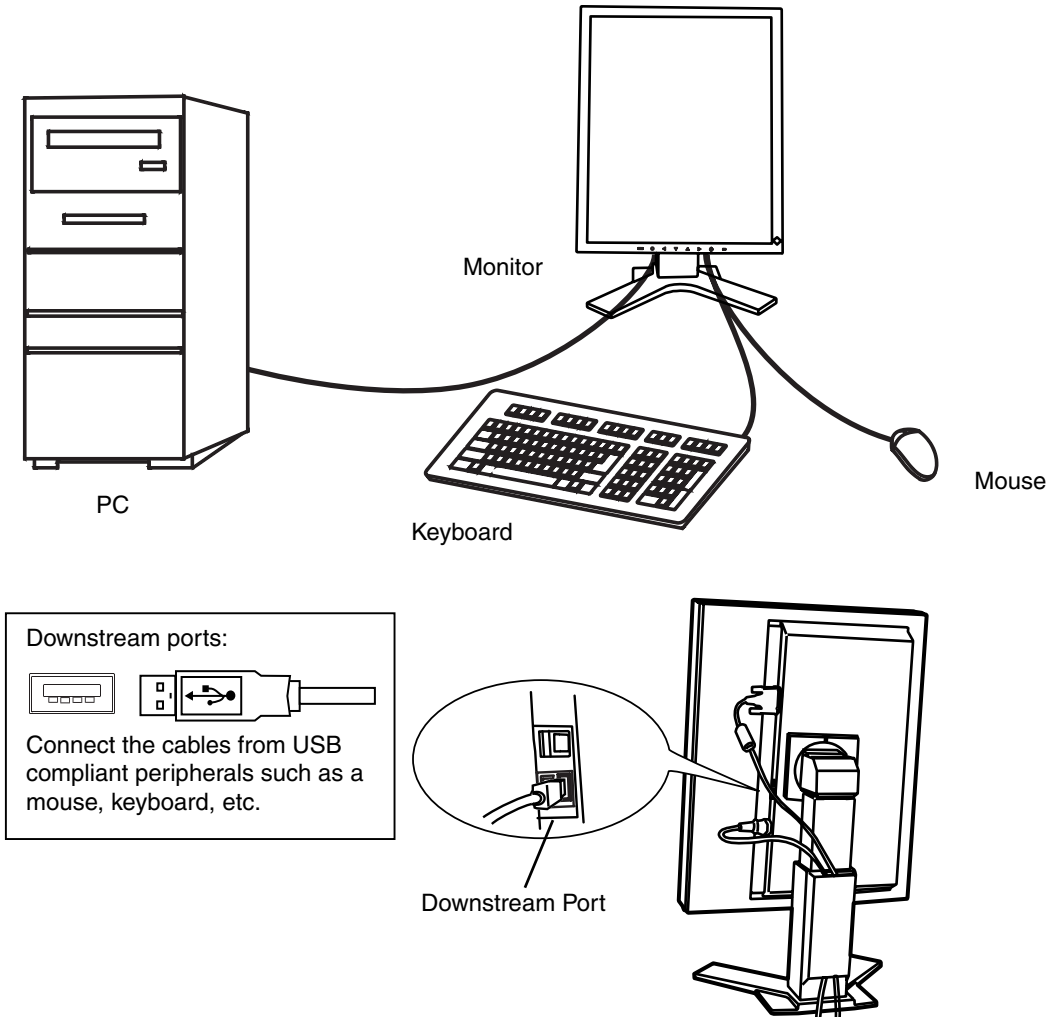

ScreenManager Pro for Medical (for Windows)

For further details about the “ScreenManager Pro for Medical (for Windows)”, refer to the EIZO LCD Utility Disk.

6. ATTACHING AN ARM

The LCD monitor can be used with an arm by removing the tilt stand and attaching the arm or stand to the LCD monitor.

NOTE

- If you will use the arm or stand of other manufacturers, confirm the followings to the manufacturers before selecting.
 - Hole spacing on the arm mounting: 100 mm x 100 mm (VESA compliant)
 - Supportable Weight: Total weight of the monitor (without stand) and attaching equipment such as a cable
 - TÜV/GS approved arm or stand
- Please connect cables after attaching an arm stand.

Setup Procedure

- 1.** Hold the center of the stand mounting cover and slide them rightward or leftward to remove the mounting cover.
- 2.** Lay the LCD monitor down. Do not scratch the panel.
- 3.** Remove the tilt stand by loosening the screws.
(4 pcs of M4 x 10 BZn/Fe)
- 4.** Attach an arm stand to the LCD monitor securely.

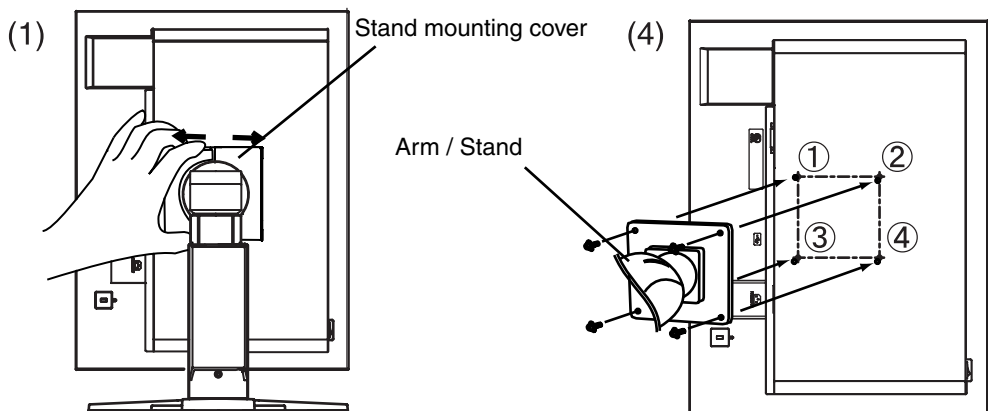

M4 Mounting Screws: M4 x 10 (mm) BZn/Fe

7. TROUBLESHOOTING

If a problem persists even after applying the remedies suggested below, contact an EIZO dealer.

- No picture problems → See No.1 ~ No.2
- Imaging problems → See No.3 ~ No.6
- Other problems → See No.7 ~ No.10
- USB problems → See No.11 ~ No.12

Problem	Points to check and possible solutions
1. No picture <ul style="list-style-type: none"> • Indicator status: Off 	<input type="checkbox"/> Check that the power cord is connected correctly. If the problem persists, turn off the monitor power for a few minutes, then turn it back on and try again.
<ul style="list-style-type: none"> • Indicator status: Green 	<input type="checkbox"/> Check the <Brightness> setting.
<ul style="list-style-type: none"> • Indicator status: Orange 	<input type="checkbox"/> Try pressing a key on the keyboard or clicking the mouse (see p. 21). <input type="checkbox"/> Try turning the PC on.
<ul style="list-style-type: none"> • Indicator status: Flashing orange slowly 	<input type="checkbox"/> Try touching the power switch (see p. 20).
2. One of the error messages shown below remains on the screen for 40 second. <div data-bbox="216 1020 559 1201" style="border: 1px solid black; padding: 5px; margin: 10px 0;"> <p style="text-align: center;">Signal Check</p> <p style="text-align: center;">Signal</p> <p>fH: 0.0kHz fV: 0.0Hz</p> </div>	<p>These messages appear when the video signal is not input correctly, even if the monitor functions properly.</p> <input type="checkbox"/> The message might appear because some PCs do not output the video signal immediately after powering on. If the image is displayed correctly after a short time, there is no problem with the monitor. <input type="checkbox"/> Check that the PC is turned on. <input type="checkbox"/> Check that the signal cable is properly connected to the PC or graphics board.
<ul style="list-style-type: none"> • The message appears when the signal is out of input range. (Example) <div data-bbox="216 1414 559 1595" style="border: 1px solid black; padding: 5px; margin: 10px 0;"> <p style="text-align: center;">Signal Error</p> <p style="text-align: center;">Signal</p> <p>fD: 165.0MHz fH: 0.0kHz fV: 0.0Hz</p> </div>	<input type="checkbox"/> Use the graphics board's utility software to change the frequency setting. (Refer to the manual of the graphics board.)
3. The screen is too bright or too dark.	<input type="checkbox"/> Adjust the <Brightness> (The backlight of the LCD monitor has a fixed life span. When the screen becomes dark or begins to flicker, please contact your dealer.)

Problem	Points to check and possible solutions
4. Afterimages appear.	<input type="checkbox"/> Do you use the screen saver or timer (p.20) when displaying the same image for extended periods of time? <input type="checkbox"/> Afterimages are particular to LCD monitors. Avoid displaying the same image for extended periods of time.
5. The screen has defective pixels (e.g. appears slightly light or dark).	<input type="checkbox"/> This is due to the characteristics of the panel itself and not the LCD product.
6. Fingerprints remain on the screen.	<input type="checkbox"/> Leaving the screen white may solve the problem
7. The ScreenManager main menu does not operate.	<input type="checkbox"/> The adjustment lock is probably on. To unlock it, first turn off the monitor. Touch the power switch while touching the enter switch, and then turn on the monitor again (see p. 19). <input type="checkbox"/> Make sure the control panel switches are not wet or soiled. Lightly wipe the surface of the control panel, and try touching the switches again with dry hands. <input type="checkbox"/> Make sure not to wear gloves. Remove any gloves, and try touching the switches again with dry hands.
8. The control panel does not operate. CAL Switch mode does not operate.	<input type="checkbox"/> Make sure the control panel switches are not wet or soiled. Lightly wipe the surface of the control panel, and try touching the switches again with dry hands. <input type="checkbox"/> Make sure not to wear gloves. Remove any gloves, and try touching the switches again with dry hands.
9. The monitor turns off while in use.	<input type="checkbox"/> Make sure the air vents are not blocked. <input type="checkbox"/> Make sure high-temperature equipment is not located nearby.
10. The signal frequency does not change after installing the "Monitor information file" from the supplied utility disk on a Windows 98/2000/Me/XP PC.	<input type="checkbox"/> Use the graphics board's utility software to change the input signal frequency.
11. The USB function does not operate.	<input type="checkbox"/> Check that the USB cable is correctly connected. <input type="checkbox"/> Check that the PC and OS are USB compliant. (For verification of USB support, consult the manufacturer of each system.) <input type="checkbox"/> Check the USB setting in the PC's BIOS. (For details, refer to the PC user's manual.)

Problem	Points to check and possible solutions
12. The PC freezes. The peripherals connected to the USB downstream ports do not operate.	<ul style="list-style-type: none"><li data-bbox="648 204 1116 266">❑ Check that the USB cable is connected correctly.<li data-bbox="648 276 1199 397">❑ Try connecting the peripheral to another USB downstream port. If the problem is solved by doing this, contact an EIZO dealer. (For details, refer to the manual of the PC.)<li data-bbox="648 407 1204 568">❑ Try executing the following method.<ul style="list-style-type: none"><li data-bbox="683 440 911 471">- Restarting the PC<li data-bbox="683 475 1204 506">- Connecting the PC and peripherals directlyIf the problem is solved by doing this, contact an EIZO dealer.<li data-bbox="648 581 1222 730">❑ The power switch on an Apple keyboard will not operate when connected to a USB downstream port on the monitor. Connect the keyboard directly to the Apple PC. (For details, refer to the Apple PC user's manual.)

8. CLEANING

Periodic cleaning is recommended to keep the monitor looking new and to prolong its operation lifetime.

NOTE

- Never use thinner, benzene, alcohol (ethanol, methanol, or isopropyl alcohol), abrasive cleaners, or other strong solvents, as these may cause damage to the cabinet or LCD panel.
- Make sure to turn off the monitor before cleaning it.

Cabinet

To remove stains, wipe the cabinet with a soft, lightly moistened cloth using a mild detergent. Do not spray wax or cleaner directly into the cabinet. (For details, refer to the PC user's manual.)

LCD Panel

- The LCD surface can be cleaned with a soft cloth, such as cotton or lens paper.
- For stubborn stains, use the cleaning kit “ScreenCleaner” or gently wipe the affected area using a cloth moistened with water or an ethanol-based cleaner.
- It is recommend to use the optional cleaning kit, “ScreenCleaner” (see p. 31). (“ScreenCleaner” is supplied with GS310-CLG.)

9. SPECIFICATIONS

LCD Panel	GS310-BL GS310-CL	52.9 cm (20.8 inch), TFT Monochrome LCD panel Anti-Glare Hard Coating 3H, Response Time : 50ms
	GS310-CLG	52.9 cm (20.8 inch), TFT Monochrome LCD panel Hard Coating 3H, Response Time : 50ms
Viewing Angle		Horizontal: 170°, Vertical: 170° (CR≥10)
Dot Pitch		0.207 mm
Horizontal Scan Frequency		31 ~ 100 kHz
Vertical Scan Frequency		48 ~ 71.5 Hz (VGA TEXT: 69 ~ 71 Hz)
Resolution		3M pixels (Portrait: 1536 × 2048 dots (H × V))
Dot Clock (Max.)		165 MHz
Gray Scale		4096 steps of 8161 steps (12bit monochrome signal input)
Brightness (Recommended)		450 cd/m ² (approx.70%)
Display Area		423.9 mm (H) × 318.0 mm (V) (16.7" (H) × 12.5" (V))
Power Supply		100-120/200-240 VAC±10%, 50/60 Hz, 1.0-0.8A /0.5-0.4 A
Power Consumption		Min. : 90 W Max.: 100 W (With USB) Power Saving Mode: Less than 3 W (for single signal input without USB) Main power off : 0 W
Input Connector		DVI-D x 1
Input Signal		TMD5 (Single Link)
Plug & Play		VESA DDC 2B / EDID structure 1.3
Dimensions	With stand	368 mm (W) x 515.5~ 597.5 mm (H) x 209 mm (D) (14.5"(W) x 20.3" ~ 23.5" (H) x 8.2"(D))
	Without stand	368 mm (W) x 486 mm (H) x 88.5mm (D) (14.5"(W) x 19.1"(H) x 3.5"(D))
Weight	With stand	9.2 kg (20.3 lbs.)
	Without stand	6.2 kg (13.7 lbs.)
Environment Conditions	Temperature	Operating: 0 °C ~ 35 °C (32 °F ~ 95 °F) Storage: - 20 °C ~ 60 °C (- 4 °F ~ 140 °F)
	Humidity	30 % to 80 % R.H. Non-condensing
	Pressure	Operating: 700 to 1,060 hPa Storage: 200 to 1,060 hPa
USB	Standard	USB Specification Revision 2.0
	USB ports	Upstream port × 1, Downstream port × 2
	Communication Speed	480 Mbps (high), 12 Mbps (full), 1.5 Mbps (low)
	Power Supply	Downstream: 500 mA for each (Max.)
Certifications and Standards		TÜV Rheinland /GM, CB, NRTL/C-TÜV, CE (93/42/EEC), FCC-B
Classification of Equipment		Type of protection against electric shock: Class I EMC class: EN60601-1-2: 2001 Group 1 Class B Classification of medical device (MDD 93/42/EEC): Class I

Dimensions

mm (inches)

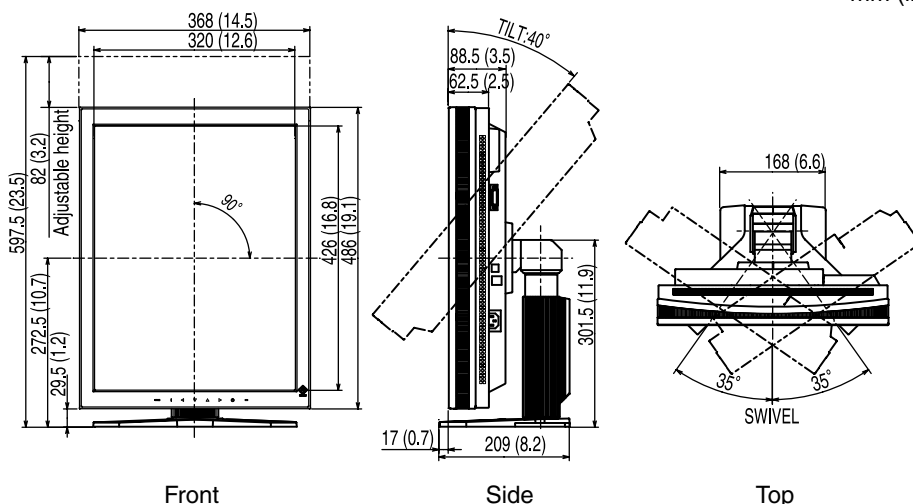

Default Settings

Signal Selection		8bit/10bit
Orientation		Portrait (SW)
CAL Switch Mode		1-DICOM
Brightness		Fixed at the factory
PowerManager		DVI DMPM
Off Timer		Disable
Menu Settings	Menu Size	Normal
	Menu Off Timer	45 seconds
Language		English

Optional

Arm, Stand	EIZO "LA-131-D" : LCD Monitor Flexible Arm EIZO "LA-030-W" : Wall Mount Arm for LCD Monitor EIZO "LA-011-W"
Graphics board	8bit, 10bit, and 12bit monochrome signals supported <ul style="list-style-type: none"> RealVision "VREngine/SMD3-PCI" RealVision "VREngine/SMD5-PCI"
	8bit and 10bit monochrome signals supported <ul style="list-style-type: none"> Matrox "MED3mp-PPP" Matrox "MED5mp-PPP"
	8bit monochrome signal supported <ul style="list-style-type: none"> RealVision "VREngine/MD3W" RealVision "VREngine/CMD3W"
Calibration Kit	EIZO "RadiCS GX2" Ver.2.3.0 or later EIZO "Clip-On Swing Sensor G1"
Network QC Management Software	EIZO "RadiNET Pro" Ver.2.3.0 or later
Cleaning kit	EIZO "ScreenCleaner"

Pin Assignment

DVI-D Connector

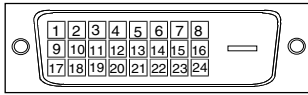

Pin No.	Signal	Pin No.	Signal	Pin No.	Signal
1	TMDS Data2-	9	TMDS Data1-	17	TMDS Data0-
2	TMDS Data2+	10	TMDS Data1+	18	TMDS Data0+
3	TMDS Data2/4 Shield	11	TMDS Data1/3 Shield	19	TMDS Data0/5 Shield
4	NC*	12	NC*	20	NC*
5	NC*	13	NC*	21	NC*
6	DDC Clock (SCL)	14	+5V Power	22	TMDS Clock shield
7	DDC Data (SDA)	15	Ground (For +5V)	23	TMDS Clock+
8	Analog Vertical Sync	16	Hot Plug Detect	24	TMDS Clock-

(*NC: No Connection)

USB Port

Upstream Downstream

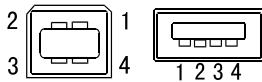

Series B Series A

No.	Signal	Signal
1	VCC	Cable power
2	- Data	Serial data
3	+ Data	Serial data
4	Ground	Cable Ground

10. GLOSSARY

DICOM

(Digital Imaging and Communication in Medicine)

The DICOM standard was developed by the American College of Radiology and the National Electrical Manufacturer's Association of the USA.

A DICOM-compatible device connection enables the transfer of medical images and information. Part 14 of DICOM defines the standards for digital, grayscale medical image display.

DVI

(Digital Visual Interface)

A digital flat panel interface. DVI can transmit digital data without loss and directly from the PC using the signal transition method “TMDS” (see p. 33).

There are two kinds of DVI connectors: the DVI-D connector for digital signal input only, and the DVI-I connector for both digital and analog signal inputs.

DVI DMPM

(DVI Digital Monitor Power Management)

The Power management system for the digital interface. The “Monitor ON” status (operation mode) and the “Active Off” status (power-saving mode) are indispensable for the DVI-DMPM as the monitor's power mode.

Resolution

The LCD panel consists of a fixed number of pixel elements which are illuminated to form the screen image. The EIZO GS310-BL/GS310-CL/GS310-CLG display panel consists of 1536 horizontal pixels and 2048 vertical pixels. At a resolution of 1536 x 2048, all pixels are displayed as a full screen.

As a standard default space, sRGB allows Internet users to closely match colors.

TMDS

(Transition Minimized Differential Signaling)

A signal transition method for the digital interface.

For U.S.A, Canada, etc. (rated 100-120 Vac) Only

FCC Declaration of Conformity

We, the Responsible Party EIZO NANAOTECHNOLOGIES INC.
5710 Warland Drive, Cypress, CA 90630
Phone: (562) 431-5011

declare that the product Trade name: EIZO
Model: RadiForce GS310

is in conformity with Part 15 of the FCC Rules. Operation of this product is subject to the following two conditions: (1) this device may not cause harmful interference, and (2) this device must accept any interference received, including interference that may cause undesired operation.

This equipment has been tested and found to comply with the limits for a Class B digital device, pursuant to Part 15 of the FCC Rules. These limits are designed to provide reasonable protection against harmful interference in a residential installation. This equipment generates, uses, and can radiate radio frequency energy and, if not installed and used in accordance with the instructions, may cause harmful interference to radio communications. However, there is no guarantee that interference will not occur in a particular installation. If this equipment does cause harmful interference to radio or television reception, which can be determined by turning the equipment off and on, the user is encouraged to try to correct the interference by one or more of the following measures.

- * Reorient or relocate the receiving antenna.
- * Increase the separation between the equipment and receiver.
- * Connect the equipment into an outlet on a circuit different from that to which the receiver is connected.
- * Consult the dealer or an experienced radio/TV technician for help.

Changes or modifications not expressly approved by the party responsible for compliance could void the user's authority to operate the equipment.

Note

Use the attached specified cable below or EIZO signal cable with this monitor so as to keep interference within the limits of a Class B digital device.

- AC Cord
- Shielded Signal Cable (enclosed)

Canadian Notice

This Class B digital apparatus complies with Canadian ICES-003.
Cet appareil numérique de la classe B est conforme à la norme NMB-003 du Canada.

Recycle Auskunft

Die Rücknahme dieses Produktes nach Nutzungsende übernimmt EIZO in Deutschland zusammen mit dem Partner eds-r gmbhrucknahmesysteme. Dort werden die Geräte in ihre Bestandteile zerlegt, die dann der Wiederverwertung zugeführt werden. Um einen Abholtermin zu vereinbaren und die aktuellen Kosten zu erfahren, benutzen Sie bitte folgende Rufnummer: 02153-73 35 00. Weitere Informationen finden Sie auch unter der Internet-Adresse: <http://www.eizo.de>.

Recycling Information for customers in Switzerland:

All recycling information is placed in the SWICO's website.
<http://www.swico.ch>

Recycling-Information für Kunden in der Schweiz:

Alle Informationen zum Thema Recycling finden Sie auf der Homepage des Branchenverbandes SWICO.
<http://www.swico.ch>

Renseignements de recyclage pour les clients en Suisse:

Vous trouvez tous les renseignements pour le sujet de recyclage sur la page WEB de l'UNION DE BRAN CHE SWICO.
<http://www.swico.ch>

Recycling Information for customers in USA:

All recycling information is placed in the EIZO Nanao Technologies, Inc's website.
<http://www.eizo.com/>

Återvinnings information för kunder i Sverige:

All information om återvinning finns på Eizo Europe AB:s hemsida:
<http://www.eizo.se>



EIZO NANA O CORPORATION

153 Shimokashiwano, Hakusan, Ishikawa 924-8566 Japan
Phone: +81 76 277 6792 Fax: +81 76 277 6793

EIZO NANA O TECHNOLOGIES INC.

5710 Warland Drive, Cypress, CA 90630, U.S.A.
Phone: +1 562 431 5011 Fax: +1 562 431 4811

EIZO EUROPE AB

Lovangsvagen 14 194 61, Upplands Väsby, Sweden
Phone: +46 8 590 80 000 Fax: +46 8 590 91 575

EIZO NANA O AG

Moosacherstrasse 6, Au CH - 8820 Wadenswil, Switzerland
Phone: +41-0-44 782 24 40 Fax: +41-0-44 782 24 50

Avnet Technology Solutions GmbH

Lötscher Weg 66, D-41334 Nettetal, Germany
Phone: +49 2153 733-400 Fax: +49 2153 733-483

株式会社ナナオ

〒924-8566 石川県白山市下柏野町153番地

This document is printed on recycled chlorine free paper.

<http://www.radiforce.com>

1st Edition-March, 2006 Printed in Japan.

00NOL219A1
(U.M-GS310-AL)