

# Installation Manual

RadiForce®  
RX650  
RX850

Color LCD monitor

## Important

Please read this Installation Manual, and “Instructions for Use” (separate volume) carefully to familiarize yourself with safe and effective usage.

- Please refer to the “Instructions for Use” for basic information ranging from connection of the monitor to a PC to using the monitor.
- The latest Installation Manual is available for download from our web site:

<http://www.eizoglobal.com>



This product has been adjusted specifically for use in the region to which it was originally shipped. If operated outside this region, the product may not perform as stated in the specifications.

---

No part of this manual may be reproduced, stored in a retrieval system, or transmitted, in any form or by any means, electronic, mechanical, or otherwise, without the prior written permission of EIZO Corporation. EIZO Corporation is under no obligation to hold any submitted material or information confidential unless prior arrangements are made pursuant to EIZO Corporation's receipt of said information. Although every effort has been made to ensure that this manual provides up-to-date information, please note that EIZO monitor specifications are subject to change without notice.

---

# CONTENTS

<b>CONTENTS</b> .....	<b>3</b>	4-3. Acquiring Life Prediction Data .....	20
<b>Chapter 1 Basic Operations and Functions</b> ....	<b>4</b>	4-4. Setting On/Off for Warning and QC History .....	21
1-1. Basic Adjustment menu operations .....	4	<b>Chapter 5 Power Saving Functions</b> .....	<b>22</b>
1-2. Functions .....	6	5-1. Setting Power Save .....	22
<b>Chapter 2 Adjusting Screens</b> .....	<b>7</b>	5-2. Adjusting the Brightness of Indicator .....	22
2-1. Compatible Resolutions .....	7	5-3. Setting the power saving mode when a person leaves the monitor .....	23
2-2. Setting the Resolution .....	7	<b>Chapter 6 Troubleshooting</b> .....	<b>24</b>
● Monitor setting.....	7	6-1. No picture .....	24
● PC setting.....	7	6-2. Imaging problems .....	25
2-3. Adjusting Color .....	9	6-3. Other problems .....	26
● To select the display mode (CAL Switch mode) .....	9	<b>Chapter 7 Reference</b> .....	<b>28</b>
● To perform advanced adjustments .....	10	7-1. How to Attach the Arm .....	28
● Adjustable settings in each mode .....	10	7-2. How to Install the Wall Mounting Device... ..	29
● To adjust brightness .....	10	7-3. Connecting Multiple PCs .....	30
● To adjust contrast .....	11	● To switch among input signals .....	30
● To adjust color temperature .....	11	● To set input signal selection .....	31
● To adjust gamma .....	12	7-4. Making Use of USB (Universal Serial Bus).....	32
● To adjust hue .....	12	● Required system environment .....	32
● To adjust saturation .....	12	● Connection procedure (Setup of USB function).....	32
● To adjust gain .....	13	7-5. Displaying Monitor Information .....	33
● To set the mode in the monochrome display area .....	13	● Displaying the signal information .....	33
● To set the detection type in the monochrome display area .....	14	● Displaying monitor information.....	33
● To set the highlight area in the monochrome display area .....	14	7-6. Main Default Settings .....	34
<b>Chapter 3 Setting Monitor</b> .....	<b>15</b>	<b>Appendix</b> .....	<b>35</b>
3-1. Skipping Unused Display Modes .....	15	LIMITED WARRANTY (RX650) .....	35
3-2. Setting Language.....	15	LIMITED WARRANTY (RX850) .....	43
3-3. Setting Adjustment Menu Display .....	15	Recycling Information .....	51
3-4. Locking Operation Switches .....	16		
3-5. Enabling/Disabling DDC Communication... ..	16		
3-6. Enabling/Disabling DC5V Output.....	17		
3-7. Showing and hiding the Grayscale Display Error .....	17		
3-8. Return To Default Setting.....	18		
● To reset the color adjustments .....	18		
● To reset all settings .....	18		
<b>Chapter 4 Controlling Monitor Quality</b> .....	<b>19</b>		
4-1. Executing Calibration.....	19		
● Executing SelfCalibration.....	19		
● Viewing SelfCalibration result .....	19		
4-2. Checking Grayscale.....	20		
● Executing Grayscale Check.....	20		
● Viewing Grayscale Check result .....	20		

# Chapter 1 Basic Operations and Functions

## 1-1. Basic Adjustment menu operations

### 1. Displaying Adjustment Menu

1. Touch one of the switches (excluding ).

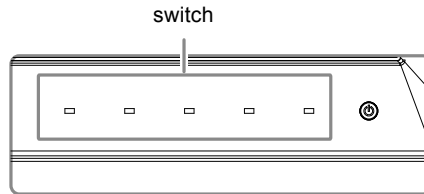

2. The guide is displayed.

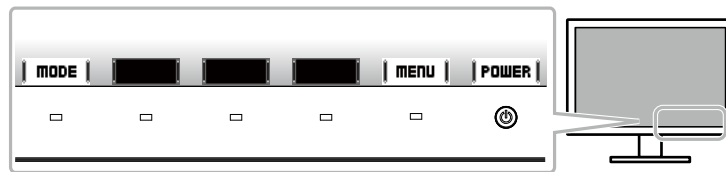

3. Select **| MENU |** to display the Adjustment menu.

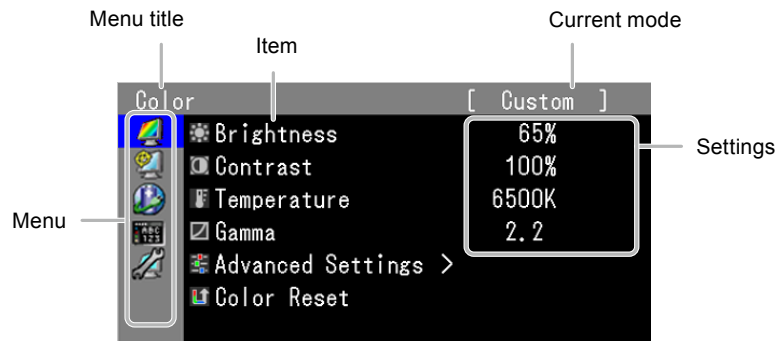

### 2. Adjusting/Setting

1. Choose a menu to adjust/set with **| ▲ |** or **| ▼ |**, and then choose **| ENTER |**.

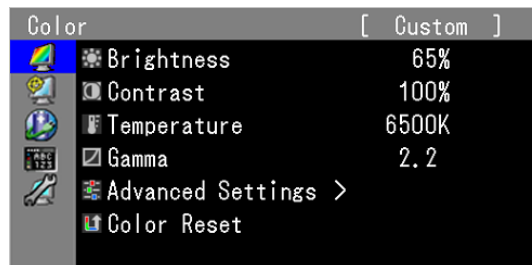

2. Choose an item to adjust/set with **| ▲ |** or **| ▼ |**, and then choose **| ENTER |**.

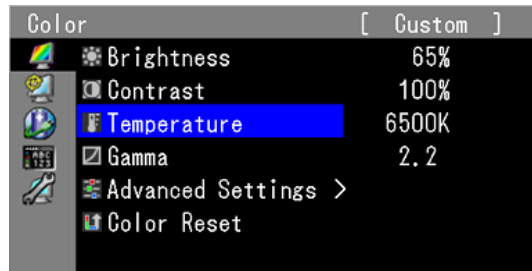

3. Adjust/set the selected item with **| ▲ |** or **| ▼ |**, and then choose **| OK |**.

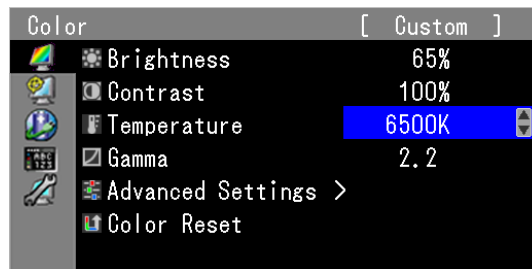





### 3. Exiting

1. Choose **| RETURN |** a few times. The Adjustment menu finishes.

# 1-2. Functions

The following table shows all the Adjustment menu's adjustment and setting menus.

Main menu	Item	Reference	
Color*1 	Brightness	"2-3. Adjusting Color" (page 9)	
	Contrast		
	Temperature		
	Gamma		
	Advanced Settings		Hue
			Saturation
			Gain
	Hybrid Area		
	Hybrid Assignment		
Highlight Area	"3-8. Return To Default Setting" (page 18)		
Color Reset			
RadiCS SelfQC 	SelfCalibration	"4-1. Executing Calibration" (page 19)	
	Grayscale Check	"4-2. Checking Grayscale" (page 20)	
	LEA	"4-3. Acquiring Life Prediction Data" (page 20)	
	Settings	"4-4. Setting On/Off for Warning and QC History" (page 21)	
PowerManager 	Power Save	"5-1. Setting Power Save" (page 22)	
	Indicator	"5-2. Adjusting the Brightness of Indicator" (page 22)	
	Presence Sensor	"5-3. Setting the power saving mode when a person leaves the monitor" (page 23)	
Menu Settings 	Language	"3-2. Setting Language" (page 15)	
	Menu Position	"3-3. Setting Adjustment Menu Display" (page 15)	
Tools 	Input	"To switch among input signals" (page 30)	
	Input Selection	"To set input signal selection" (page 31)	
	Mode Skip	"3-1. Skipping Unused Display Modes" (page 15)	
	Signal Info	"7-5. Displaying Monitor Information" (page 33)	
	Monitor Info		
	All Reset	"3-8. Return To Default Setting" (page 18)	
Optional Settings	Key Lock	"3-4. Locking Operation Switches" (page 16)	
	DDC	"3-5. Enabling/Disabling DDC Communication" (page 16)	
	DC5V Output	"3-6. Enabling/Disabling DC5V Output" (page 17)	
	Resolution	"2-2. Setting the Resolution" (page 7)	
	Grayscale Warning	"3-7. Showing and hiding the Grayscale Display Error" (page 17)	

\*1 The adjustment/settings available on "Color" depend on the selected mode. (See "Adjustable settings in each mode" (page 10).)

# Chapter 2 Adjusting Screens

## 2-1. Compatible Resolutions

For details on compatible resolutions, refer to “Compatible Resolutions” in the “Instructions for Use”.

## 2-2. Setting the Resolution

When you connect the monitor to the PC and find that the resolution is improper, or when you want to change the resolution, follow the procedure below.

### ● Monitor setting

#### Procedure

1. Touch  $\odot$  to turn off the monitor.
2. While holding down the  $\text{MODE}$  switch at the far left, touch  $\odot$  for at least two seconds to turn on the monitor.  
The “Optional Settings” menu appears.
3. Choose “Resolution” from “Optional Settings”, and choose  $\text{ENTER}$ .
4. Select one of the following settings using  $\blacktriangle$  or  $\blacktriangledown$ , and then choose  $\text{OK}$ .

	Setting	Details	
RX650	Full	DisplayPort	1640×2048×2
		DVI	1640×2048×2
	6MP	DisplayPort	1536×2048×2
		DVI	1536×2048×2
RX850	8MP	DisplayPort	2048×2160×2
		DVI	2048×2160×2
	QFHD	DisplayPort	1920×2160×2
		DVI	1920×2160×2

5. Select “Finish” with  $\blacktriangle$  or  $\blacktriangledown$ .
6. Choose  $\text{ENTER}$ .  
The “Optional Settings” menu is closed.

### ● PC setting

#### Windows 8 / Windows 7

1. For Windows 8, click the “Desktop” tile on the Start Screen to display the desktop.
2. Right-click the mouse anywhere on the desktop except for icons.
3. From the displayed menu, click “Screen resolution”.
4. On the “Screen Resolution” dialog box, select the monitor.
5. Click “Resolution” to select the desired resolution.
6. Click the “OK” button.
7. When a confirmation dialog box is displayed, click “Keep changes”.

## Windows Vista

1. Right-click the mouse anywhere on the desktop except for icons.
2. From the displayed menu, click "Personalize".
3. On the "Personalization" window, click "Display Settings".
4. On the "Display Settings" dialog box, select the "Monitor" tab and select desired resolution in the "Resolution" field.
5. Click the "OK" button.
6. When a confirmation dialog box is displayed, click "Yes".

## Windows XP

1. Right-click the mouse anywhere on the desktop except for icons.
2. From the displayed menu, click "Properties".
3. When the "Display Properties" dialog box is displayed, click the "Settings" tab and select desired resolution for "Screen resolution" under "Display".
4. Click the "OK" button to close the dialog box.

## Mac OS X

1. Select "System Preferences" from the Apple menu.
2. When the "System Preferences" dialog box is displayed, click "Displays" for "Hardware".
3. On the displayed dialog box, select the "Display" tab and select desired resolution in the "Resolutions" field.
4. Your selection will be reflected immediately. When you are satisfied with the selected resolution, close the window.



## 2-3. Adjusting Color

### ● To select the display mode (CAL Switch mode)

This function allows easy selection of a desired mode according to monitor application.

#### Color Mode

√: Calibration is available

Mode	Purpose	
1-DICOM	Available to display in DICOM mode.	√
2-Custom	Select one of these user modes to define a desired set of parameter settings.	√
3-CAL1	Displays the screen adjusted by calibration software.	√
4-CAL2		
5-CAL3		
6-Hybrid-γ	Automatically identifies the display area for the monochrome and color images on the same screen, and displays each set status.	-
7-sRGB	Suitable for color matching with sRGB compatible peripherals.	-
8-Text	Suitable for displaying texts for word processing or spreadsheets.	-

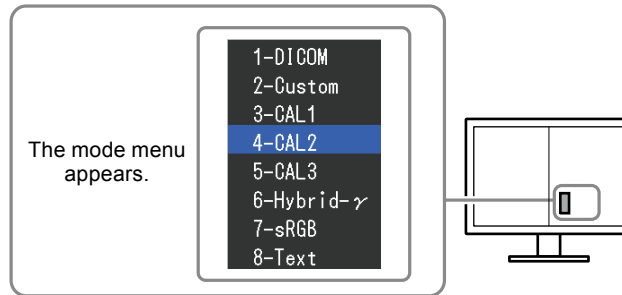

#### Procedure

1. Touch one of the switches (excluding  $\text{⏻}$  ).  
The guide is displayed.
2. Choose | **MODE** |.  
The mode menu appears at the bottom left of the right screen.
3. The mode among the list is highlighted in turn each time is | **MODE** | chosen.  
You can switch the mode with |  $\blacktriangle$  | or |  $\blacktriangledown$  | while the mode menu is displayed.

→ 1-DICOM ← → 2-Custom ← → 3-CAL1 ← → 4-CAL2 ← → 5-CAL3 ← → 6-Hybrid-γ ← → 7-sRGB ← → 8-Text ← →

#### Note

- The Adjustment menu and the Mode menu cannot be displayed at the same time.

## ● To perform advanced adjustments

“Color” of the Adjustment menu allows you to configure and save a separate set of color settings for each mode.

### Attention

- The monitor will take about 30 minutes before its internal electric components stabilize. Wait 30 minutes or more after turning the monitor power on before starting adjustment.
- The same image may be seen in different colors on multiple monitors due to their monitor-specific characteristics. Make fine color adjustment visually when matching colors on multiple monitors.











### Note

- The values shown in “%” or “K” are available only as reference.

## ● Adjustable settings in each mode

The adjustable settings depend on the mode. (You cannot select any non-adjustable or non-settable function.)

√: Adjustable -: Not adjustable

Icon	Function	CAL Switch mode					
		1-DICOM*1	2-Custom*1	3-CAL1*1 4-CAL2*1 5-CAL3*1	6-Hybrid-y	7-sRGB	8-Text
	Brightness	√	√	√	-	√	√
	Contrast	-	√	-	-	-	√
	Temperature	-	√	-	-	√	√
	Gamma	-	√	-	-	-	√
	Hue	-	√	-	-	-	√
	Saturation	-	√	-	-	-	√
	Gain	-	√	-	-	-	-
	Hybrid Area	-	-	-	√	-	-
	Hybrid Assignment	-	-	-	√	-	-
	Highlight Area	-	-	-	√	-	-
	Color Reset	√	√	√	√	√	√

\*1 If you adjust the calibration in this mode using the calibration kit exclusive for to this monitor (see RadiCS LE /"Accessories" in the "instructions for Use".), only “Brightness” and “Color Reset” are adjustable.

## ● To adjust brightness

The screen brightness is adjusted by changing the brightness of the backlight (light source from the LCD back panel).

### Adjustable range

0 to 100%

### Procedure

1. Choose “Color” from the Adjustment menu, and choose | **ENTER** |.
2. Choose “Brightness” from “Color”, and choose | **ENTER** |.
3. Use | **▲** | or | **▼** | for adjustment.
4. Choose | **OK** | to exit.

### Note

- If you feel that the image is too dark even if the brightness is set to 100%, adjust the contrast.

## ● To adjust contrast

The luminance of the screen is adjusted by varying the video signal level.

### **Adjustable range**

0 to 100%

### **Procedure**

1. Choose “Color” from the Adjustment menu, and choose | **ENTER** |.
2. Choose “Contrast” from “Color”, and choose | **ENTER** |.  
“Contrast” appears.
3. Use | ▲ | or | ▼ | for adjustment.
4. Choose | **OK** | to exit.

---

#### **Note**

- In the contrast of 100%, every color gradation is displayed.
  - When adjusting the monitor, it is recommended to perform the brightness adjustment which may not lose the gradation characteristics, prior to the contrast adjustment.
  - Perform the contrast adjustment in the following cases.
    - When you feel the image is too bright even if the brightness is set to 0% (Set the contrast to lower than 100%.)
- 

## ● To adjust color temperature

The color temperature can be adjusted.

The color temperature is normally used to express the hue of “White” and/or “Black” by a numerical value. The value is expressed in degrees “K” (Kelvin).

The screen becomes reddish at a low color temperature, and bluish at a high color temperature, like the flame temperature. The gain preset values are set for each color temperature setting value.

### **Adjustable range**

Native, 6000K-15000K (specified every 100K), User, Standard

### **Procedure**

1. Choose “Color” from the Adjustment menu, and choose | **ENTER** |.
2. Choose “Temperature” from “Color”, and choose | **ENTER** |.
3. Use | ▲ | or | ▼ | for adjustment.
4. Choose | **OK** | to exit.

---

#### **Note**

- “Gain” allows you to perform more advanced adjustment (see [“To adjust gain” \(page 13\)](#)).
  - If you set “Native”, the image is displayed in the preset color of the monitor (Gain: 100% for each RGB).
  - When gain is changed, the color temperature is changed to “User”.
-

## ● To adjust gamma

Gamma can be adjusted. The brightness of the monitor varies depending on the input signal, however, the variation rate is not proportional to the input signal. To keep the balance between the input signal and the brightness of the monitor is called as “Gamma correction”.

### **Adjustable range**

1.6 to 2.7

### **Procedure**

1. Choose “Color” from the Adjustment menu, and choose | **ENTER** |.
2. Choose “Gamma” from “Color”, and choose | **ENTER** |.
3. Use | **▲** | or | **▼** | for adjustment.
4. Choose | **OK** | to exit.

## ● To adjust hue

This function allows you to adjust the hue.

### **Adjustable range**

-100 to 100

### **Procedure**

1. Choose “Color” from the Adjustment menu, and choose | **ENTER** |.
2. Choose “Advanced Settings” from “Color”, and choose | **ENTER** |.
3. Choose “Hue”, and choose | **ENTER** |.
4. Use | **▲** | or | **▼** | for adjustment.
5. Choose | **OK** | to exit.

---

#### **Attention**

- Using this function may make some color gradations unavailable for display.
- 

## ● To adjust saturation

This function allows you to adjust color saturation.

### **Adjustable range**

-100 to 100

### **Procedure**

1. Choose “Color” from the Adjustment menu, and choose | **ENTER** |.
2. Choose “Advanced Settings” from “Color”, and choose | **ENTER** |.
3. Choose “Saturation”, and choose | **ENTER** |.
4. Use | **▲** | or | **▼** | for adjustment.
5. Choose | **OK** | to exit.

---

#### **Attention**

- Using this function may make some color gradations unavailable for display.
- 

#### **Note**

- The minimum value (-100) changes the screen to monochrome.
-

## ● To adjust gain

The brightness of each color component red, green, and blue is called Gain. You can change the hue of “white” by adjusting gain.

### **Adjustable range**

0 to 100%

### **Procedure**

1. Choose “Color” from the Adjustment menu, and choose | **ENTER** |.
2. Choose “Advanced Settings” from “Color”, and choose | **ENTER** |.
3. Choose “Gain”, and choose | **ENTER** |.
4. Choose the color for adjustment from “Red”, “Green”, and “Blue”, and choose | **ENTER** |.
5. Use | **▲** | or | **▼** | for adjustment.
6. Choose | **OK** | to exit.

---

### **Attention**

- Using this function may make some color gradations unavailable for display.

### **Note**

- The value of gain changes with that of color temperature.
  - When gain is changed, the color temperature is changed to “User”.
- 

## ● To set the mode in the monochrome display area

The mode suitable for the monochrome image display area can be set (see [“To select the display mode \(CAL Switch mode\)” \(page 9\)](#)).

### **Adjustable range**

DICOM, CAL1, CAL2, CAL3

### **Procedure**

1. Choose “Color” from the Adjustment menu, and choose | **ENTER** |.
2. Choose “Hybrid Area” from “Color”, and choose | **ENTER** |.
3. Use | **▲** | or | **▼** | for adjustment.
4. Choose | **OK** | to exit.

---

### **Attention**

- You cannot select any mode for which Mode Preset is “Off” (see [“3-1. Skipping Unused Display Modes” \(page 15\)](#)).
- If all “Mode Preset” for DICOM/CAL1/CAL2/CAL3 are set to “Off”, the mode selected last is set.

### **Note**

- The mode excluding the monochrome image display area is “Custom” mode.
  - The Brightness is the same as the value for the mode selected. To change the brightness, use the mode selected for adjustment.
-

## ● To set the detection type in the monochrome display area

You can set the detection type in the monochrome image display area.

### **Procedure**

1. Choose “Color” from the Adjustment menu, and choose | **ENTER** |.
2. Choose “Hybrid Assignment” from “Color”, and choose | **ENTER** |.
3. Select “Full Scan” or “Custom” with | ▲ | or | ▼ |.
4. Choose | **OK** | to exit.

Detection Type	Purpose
Full Scan	Identifies the monochrome image display area automatically.
Custom	Allows you to set the monochrome image display area manually using software.

## ● To set the highlight area in the monochrome display area

You can set On/Off for the highlight area in the monochrome image display area.

### **Procedure**

1. Choose “Color” from the Adjustment menu, and choose | **ENTER** |.
2. Choose “Highlight Area” from “Color”, and choose | **ENTER** |.
3. Select “On” or “Off” with | ▲ | or | ▼ |.
4. Choose | **OK** | to exit.

---

### **Note**

- You can set On/Off for the highlight area with | ■■ |.
-

# Chapter 3 Setting Monitor

## 3-1. Skipping Unused Display Modes

This function selects / deselects modes that should be skipped.

Use this function when all the display modes are not available or when keeping the display mode unchanged.

### Procedure

1. Choose “Tools” from the Adjustment menu, and choose | **ENTER** |.
2. Choose “Mode Skip” from “Tools”, and choose | **ENTER** |.
3. Use | **▲** | or | **▼** | to select the mode to change, and choose | **ENTER** |.
4. Select “Skip” or “-” with | **▲** | or | **▼** |.
5. Choose | **OK** | to exit.

### Attention

- You cannot set all the modes disable. Set at least one mode to “-”.

## 3-2. Setting Language

This function allows you to select a language for the Adjustment menu and messages.

### Selectable languages

English, German, French, Spanish, Italian, Swedish, Japanese, Simplified Chinese, Traditional Chinese

### Procedure

1. Choose “Menu Settings” from the Adjustment menu, and choose | **ENTER** |.
2. Choose “Language” from “Menu Settings”, and choose | **ENTER** |.
3. Select a language with | **▲** | or | **▼** |.
4. Choose | **OK** | to exit.

## 3-3. Setting Adjustment Menu Display

You can change the display position of the Adjustment menu. The Adjustment menu is displayed on the right screen.

### Procedure

1. Choose “Menu Settings” from the Adjustment menu, and choose | **ENTER** |.
2. Choose “Menu Position” from “Menu Settings”, and choose | **ENTER** |.
3. Choose the position with | **▲** | or | **▼** |.
4. Choose | **OK** | to exit.

## 3-4. Locking Operation Switches

This function allows you to lock the adjusted/set status to prevent changing them.

### Procedure

1. Touch  $\mathcal{U}$  to turn off the monitor.
2. While holding down the  $\text{MODE}$  switch at the far left, touch  $\mathcal{U}$  for at least two seconds to turn on the monitor.

The “Optional Settings” menu appears.

3. Choose “Key Lock” from “Optional Settings”, and choose  $\text{ENTER}$ .
4. Choose “Off”, “Menu”, or “All” with  $\blacktriangle$  or  $\blacktriangledown$ , and choose  $\text{ENTER}$ .

Settings	Switches that can be locked
Off (Default setting)	None (All switches are enabled)
Menu	$\text{MENU}$ switches (adjustments/settings using the Adjustment menu)
All	All switches excluding $\mathcal{U}$

5. Select “Finish” with  $\blacktriangle$  or  $\blacktriangledown$ .
6. Choose  $\text{ENTER}$ .

The “Optional Settings” menu is closed.

## 3-5. Enabling/Disabling DDC Communication

This function allows you to enable/disable the DDC communication. Normally, turn it on during use. (This is different from the DDC/CI communication.)

### Attention

- The DDC communication uses signal 1 (DVI) only.

### Procedure

1. Touch  $\mathcal{U}$  to turn off the monitor.
2. While holding down the  $\text{MODE}$  switch at the far left, touch  $\mathcal{U}$  for at least two seconds to turn on the monitor.

The “Optional Settings” menu appears.

3. Choose “DDC” from “Optional Settings”, and choose  $\text{ENTER}$ .
4. Select “On” or “Off” with  $\blacktriangle$  or  $\blacktriangledown$ , and choose  $\text{ENTER}$ .
5. Select “Finish” with  $\blacktriangle$  or  $\blacktriangledown$ .
6. Choose  $\text{ENTER}$ .

The “Optional Settings” menu is closed.



## 3-6. Enabling/Disabling DC5V Output

This function allows you to enable/disable the DC5V output. Normally, turn it off during use.

### Procedure

1. Touch  $\mathcal{U}$  to turn off the monitor.
2. While holding down the | **MODE** | switch at the far left, touch  $\mathcal{U}$  for at least two seconds to turn on the monitor.

The “Optional Settings” menu appears.

3. Choose “DC5V Output” from “Optional Settings”, and choose | **ENTER** |.
4. Select “On” or “Off” with |  $\blacktriangle$  | or |  $\blacktriangledown$  |, and choose | **ENTER** |.
5. Select “Finish” with |  $\blacktriangle$  | or |  $\blacktriangledown$  |.
6. Choose | **ENTER** |.

The “Optional Settings” menu is closed.

## 3-7. Showing and hiding the Grayscale Display Error

If a 6bit (64 color) signal is detected when connecting to the DisplayPort, a grayscale display error can be displayed. If the error message appears, please turn off the main power for the AC adapter, and then turn it on again.

### Attention

- Always use with this set to “ON” (the default setting is “ON”).
- Set this to “OFF” only when using 6bit (64 grayscale) display.

### Procedure

1. Touch  $\mathcal{U}$  to turn off the monitor.
2. While holding down the | **MODE** | switch at the far left, touch  $\mathcal{U}$  for at least two seconds to turn on the monitor.

The “Optional Settings” menu appears.

3. Choose “Grayscale Warning” from “Optional Settings”, and choose | **ENTER** |.
4. Select “On” or “Off” with |  $\blacktriangle$  | or |  $\blacktriangledown$  |, and choose | **ENTER** |.
5. Select “Finish” with |  $\blacktriangle$  | or |  $\blacktriangledown$  |.
6. Choose | **ENTER** |.

The “Optional Settings” menu is closed.

## 3-8. Return To Default Setting

---

There are two different Resets: Color Reset for only resetting the color adjustments to the default settings and All Reset for resetting all settings to the defaults.

---

**Attention**

- After resetting, you cannot undo the operation.

---

**Note**

- Regarding the default setting, see [“7-6. Main Default Settings” \(page 34\)](#).
- 

### ● To reset the color adjustments

This function only resets the color adjustment value for the currently selected mode to the default settings.

**Procedure**

1. Choose “Color” from the Adjustment menu, and choose | **ENTER** |.
2. Choose “Color Reset” from “Color”, and choose | **ENTER** |.
3. Select “Execute” with | ▲ | or | ▼ |.
4. Choose | **ENTER** |.

The color adjustments revert to the default settings.

### ● To reset all settings

This function resets all adjustments to the default settings (except the “Input” and “Optional Settings” menus).

**Procedure**

1. Choose “Tools” from the Adjustment menu, and choose | **ENTER** |.
2. Choose “All Reset” from “Tools”, and choose | **ENTER** |.
3. Select “Execute” with | ▲ | or | ▼ |.
4. Choose | **ENTER** |.

All settings excluding the “Input” and “Optional Settings” menus are reset to the default settings.

# Chapter 4 Controlling Monitor Quality

This product has the built-in Integrated Front Sensor, which allows the user to perform periodic calibration and Grayscale Check for the monitor independently.

## Note

- To perform advanced quality control that conforms to medical standards, use the optional monitor quality control software kit “RadiCS UX1”.
- Perform correlation using RadiCS/RadiCS LE to adjust the measurement result of the Integrated Front Sensor to the measurement result of the UX1 sensor for reference. Periodical correlation enables the measurement accuracy of the Integrated Front Sensor equivalent to that of the UX1 sensor. For details, refer to RadiCS/RadiCS LE User’s Manual.
- “RadiCS” allows you to set the adjustment target for the calibration and judgment value for Grayscale Check, and also the schedule for the calibration and Grayscale Check.
- The supplied “RadiCS LE” software also allows you to set the adjustment target and schedule for the calibration. For details, refer to RadiCS LE User’s Manual (on the CD-ROM).

## 4-1. Executing Calibration

This function allows you to execute SelfCalibration and view the latest result. In addition, when the schedule is set using RadiCS/RadiCS LE, the next calibration schedule appears.

### ● Executing SelfCalibration

#### Procedure

1. Choose “RadiCS SelfQC” from the Adjustment menu, and choose | **ENTER** |.
2. Choose “SelfCalibration” from the “RadiCS SelfQC” menu, and choose | **ENTER** |.
3. Select “Execute” with | **▲** | or | **▼** |.
4. Choose | **OK** | to exit.  
SelfCalibration is executed.

#### Attention

- After SelfCalibration has been executed, perform the Grayscale Check based on the actual temperature and illuminance of the working environment.

### ● Viewing SelfCalibration result

#### Attention

- The result can be viewed when “QC History” is “On”. (See [“4-4. Setting On/Off for Warning and QC History” \(page 21\).](#))

#### Procedure

1. Choose “RadiCS SelfQC” from the Adjustment menu, and choose | **ENTER** |.
2. Choose “SelfCalibration” from the “RadiCS SelfQC” menu, and choose | **ENTER** |.
3. Select “Result” with | **▲** | or | **▼** |.
4. Select “DICOM”, “Custom”, “CAL1”, “CAL2” or “CAL3” with | **▲** | or | **▼** |.
5. Choose | **OK** | to exit.  
The SelfCalibration result (Max. Error Rate, Last Time, and Error Code) appears.

## 4-2. Checking Grayscale

This function allows you to execute Grayscale Check and view the latest result. In addition, when the schedule is set using RadiCS, the next grayscale check schedule appears.

### ● Executing Grayscale Check

---

**Attention**

- Perform the Grayscale Check based on the actual temperature and illuminance of the working environment.
- 

**Procedure**

1. Choose “RadiCS SelfQC” from the Adjustment menu, and choose | **ENTER** |.
2. Choose “Grayscale Check” from the “RadiCS SelfQC” menu, and choose | **ENTER** |.
3. Select “Execute” with | ▲ | or | ▼ |.
4. Choose | **OK** | to exit.

Grayscale Check is executed.

### ● Viewing Grayscale Check result

---

**Attention**

- The result can be viewed when “QC History” is “On”.
- 

**Procedure**

1. Choose “RadiCS SelfQC” from the Adjustment menu, and choose | **ENTER** |.
2. Choose “Grayscale Check” from the “RadiCS SelfQC” menu, and choose | **ENTER** |.
3. Select “Result” with | ▲ | or | ▼ |.
4. Select “DICOM”, “Custom”, “CAL1”, “CAL2” or “CAL3” with | ▲ | or | ▼ |.
5. Choose | **OK** | to exit.

Up to the five latest Grayscale Check results (Passed/Failed/Canceled/ERR) appear.

## 4-3. Acquiring Life Prediction Data

The data necessary to predict the monitor life can be acquired.

---

**Note**

- Data are collected every 100 hours.
  - When you select “Power Save”, data are collected when the mode switches to Power Save or when the power is shut down after 100 hours.
  - When you select “Routine” or “Power Save”, the Integrated Front Sensor performs measurement during data collection. When you select “Off”, measurement using the Integrated Front Sensor is not performed during data collection.
  - Data are saved after the following times have elapsed.
    - 500, 1000, 2000, 4000, 7000, 10000, 15000, 20000, 25000, 30000 hours
- 

**Procedure**

1. Select “RadiCS SelfQC” from the Adjustment menu, and choose | **ENTER** |.
2. Select “LEA” from “RadiCS SelfQC”, and choose | **ENTER** |.
3. Select “Meas. Frequency” with | ▲ | or | ▼ |.
4. Select “Power Save”, “Routine”, or “Off” with | ▲ | or | ▼ |.
5. Choose | **OK** | to exit.

## 4-4. Setting On/Off for Warning and QC History

This function allows you to set On/Off for Warning and QC History when the Grayscale Check result is Failed.

### **Procedure**

1. Choose “RadiCS SelfQC” from the Adjustment menu, and choose | **ENTER** |.
2. Choose “Settings” from the “RadiCS SelfQC” menu, and choose | **ENTER** |.
3. Select “Warning” or “QC History” with | **▲** | or | **▼** |.
4. Select “On” or “Off” with | **▲** | or | **▼** |.
5. Choose | **OK** | to exit.

# Chapter 5 Power Saving Functions

## 5-1. Setting Power Save

This function allows you to set the monitor into the power saving mode according to the PC status. When the monitor has shifted to the power saving mode, the images on the screen are not displayed.

### Attention

- Turning off the AC adapter main power switch or unplugging the power cord completely shuts off power supply to the monitor.
- Devices connected to the USB upstream port and USB downstream port work when the monitor is in power saving mode or when the power switch of the monitor is Off. Therefore, power consumption of the monitor varies with connected devices even in the power saving mode.
- Five seconds before the monitor enters the power saving mode, it displays a preliminary message.

### Procedure

1. Choose “PowerManager” from the Adjustment menu, and choose | **ENTER** |.
2. Choose “Power Save” from “PowerManager”, and choose | **ENTER** |.
3. Select “Off”, “High”, or “Low” with | **▲** | or | **▼** |.

Setting	Function
High	Turns off the backlight. The power saving effect is the greatest.
Low	Turns down the backlight to the lowest setting. The time until the operation stabilizes after exiting the Power Save mode next time can be reduced.

4. Choose | **OK** | to exit.

### Power Saving System

#### At DVI signal input

This monitor complies with the “DVI DMPM” standard.

#### At DisplayPort signal input

This monitor complies with the “DisplayPort Standard V1.1a”.

The monitor enters the power saving mode after five seconds in connection with the PC setting.

PC	Monitor	Power Indicator
On	Operating	Green
Power saving mode	Power saving mode	Orange

## 5-2. Adjusting the Brightness of Indicator

The brightness of the power indicator (green) when the screen is displayed can be adjusted (default setting is set to light up when power is turned on, and brightness is set to 4).

### Procedure

1. Choose “PowerManager” from the Adjustment menu, and choose | **ENTER** |.
2. Choose “Indicator” from “PowerManager”, and choose | **ENTER** |.
3. Select the indicator brightness “Off” or in the range from 1 to 7 with | **▲** | or | **▼** | as desired.
4. Choose | **OK** | to exit.

## 5-3. Setting the power saving mode when a person leaves the monitor

The sensor on the front of the monitor detects the movement of the operator when Presence Sensor is set to “On”. When a person moves away from the monitor, it shifts to the power saving mode automatically and does not display the images on the screen to reduce the power consumption. When a person comes near the monitor again, it recovers from the power saving mode and displays the images. The sensitivity and time until the power saving mode is activated can be set according to the monitor usage environment and movement of the user.

### Note

- At the time of shifting to power saving mode, the message that indicates shifting is displayed.

### Attention

- This setting cannot be used during “RadiCS SelfQC” execution.

### Procedure

1. Select “PowerManager” from the Adjustment menu, and choose | **ENTER** |.
2. Select “Presence Sensor” from “PowerManager”, and choose | **ENTER** |.
3. Select “On” or “Off” with | **▲** | or | **▼** |.
4. Choose | **OK** | to exit.
5. After selecting “On”, set the details.

Item	Setting Range	Description
Time	5, 30 sec 1, 3, 5, 10, 15, 30, 45, 60 min	Specifies the time from when a person leaves the monitor until the “No Presence detected” message appears. The monitor shifts to the power saving mode about 20 seconds after the message is displayed.
Sensitivity	Level 5 Level 4 Level 3 Level 2 Level 1	When the setting level is high (“Level 5” at maximum), even minor movements of a person are detected, causing the monitor to shift to the power saving mode only infrequently. On the other hand, when the setting level is low (“Level 1” at minimum), only major movements of a person are detected, allowing the monitor to shift to the power saving mode frequently. The Presence Sensor function is activated when the sensor on the front of the monitor detects the movement of heat. Therefore, the sensitivity should be changed depending on the typical user’s clothes or the typical room temperature. If the monitor shifts to or recovers from the power saving mode contrary to your expectations, try changing the setting level.
Reset	-	This function resets all adjustments to the default settings.

### Note

- To use the monitor comfortably, increase the sensitivity for high temperatures, which reduces the detection sensitivity, and reduce the sensitivity for low temperatures, which increases the detection sensitivity.

# Chapter 6 Troubleshooting

If a problem still remains after applying the suggested remedies, contact your local EIZO representative.

## 6-1. No picture

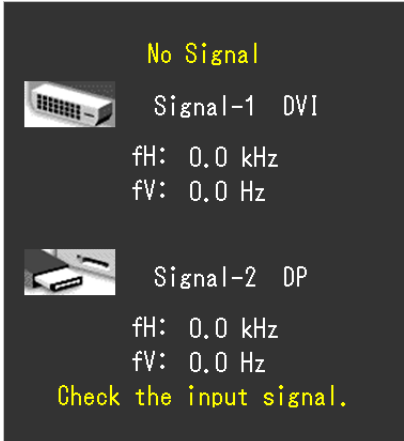
Problem	Possible cause and remedy
<b>1. No picture</b> <ul style="list-style-type: none"> <li>Power indicator does not light.</li> </ul>	<ul style="list-style-type: none"> <li>Check whether the power cord and the adapter power cable are connected properly.</li> <li>Turn the AC adapter main power switch on.</li> <li>Touch .</li> <li>Turn off the AC adapter main power, and then turn it on again a few minutes later.</li> </ul>
<ul style="list-style-type: none"> <li>Power indicator is lighting green.</li> </ul>	<ul style="list-style-type: none"> <li>Increase "Brightness", "Contrast", and/or "Gain" in the Adjustment menu (see <a href="#">"To perform advanced adjustments"</a> (page 10)).</li> <li>Turn off the AC adapter main power, and then turn it on again.</li> </ul>
<ul style="list-style-type: none"> <li>Power indicator is lighting orange.</li> </ul>	<ul style="list-style-type: none"> <li>Switch the input signal (see <a href="#">"To switch among input signals"</a> (page 30)).</li> <li>Move the mouse or press any key on the keyboard.</li> <li>Check whether the PC is turned on.</li> <li>When Presence Sensor is set to "On", the monitor may have shifted to power saving mode. Come near to the monitor.</li> <li>Turn off the AC adapter main power, and then turn it on again.</li> </ul>
<ul style="list-style-type: none"> <li>Power indicator flashes orange and green.</li> </ul>	<ul style="list-style-type: none"> <li>The device that is connected using DisplayPort have a problem. Solve the problem, turn off the monitor, and then turn it on again. Refer to the user's manual of the device that uses DisplayPort connection for details.</li> </ul>
<b>2. The message below appears.</b>	This message appears when the signal is not input correctly even when the monitor functions properly.
<ul style="list-style-type: none"> <li>This message appears when no signal is input. Example:</li> </ul> 	<ul style="list-style-type: none"> <li>The message shown left may appear, because some PCs do not output the signal soon after power-on.</li> <li>Check whether the PC is turned on.</li> <li>Check whether the signal cable is connected properly.</li> <li>Switch the input signal (see <a href="#">"To switch among input signals"</a> (page 30)).</li> </ul>

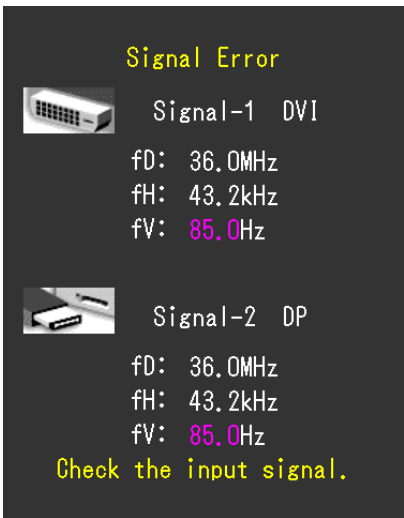

Problem	Possible cause and remedy
<ul style="list-style-type: none"> <li>The message shows that the input signal is out of the specified frequency range. (Such signal frequency is displayed in magenta.) Example:</li> </ul>  <p>fD: Dot clock fH: Horizontal scan frequency fV: Vertical scan frequency</p>	<ul style="list-style-type: none"> <li>Check whether the PC is configured to meet the resolution and vertical scan frequency requirements of the monitor (see “Compatible Resolutions” in the “Instructions for Use”).</li> <li>Reboot the PC.</li> <li>Select an appropriate setting using the graphics board’s utility. Refer to the manual of the graphics board for details.</li> </ul>

## 6-2. Imaging problems

Problem	Possible cause and remedy
1. The screen is too bright or too dark.	<ul style="list-style-type: none"> <li>Use “Brightness” or “Contrast” in the Adjustment menu to adjust it. (The LCD monitor backlight has a limited life span. When the screen becomes dark or begins to flicker, contact your local EIZO representative.)</li> </ul>
2. Characters are blurred.	<ul style="list-style-type: none"> <li>Check whether the PC is configured to meet the resolution and vertical scan frequency requirements of the monitor (see “Compatible Resolutions” in the “Instructions for Use”).</li> </ul>
3. Afterimages appear.	<ul style="list-style-type: none"> <li>Afterimages are particular to LCD monitors. Avoid displaying the same image for a long time.</li> <li>Use the screen saver or power saving function to avoid displaying the same image for extended periods of time.</li> </ul>
4. Green/red/blue/white dots or defective dots remain on the screen.	<ul style="list-style-type: none"> <li>This is due to LCD panel characteristics and is not a failure.</li> </ul>
5. Interference patterns or pressure marks remain on the screen.	<ul style="list-style-type: none"> <li>Leave the monitor with a white or black screen. The symptom may disappear.</li> </ul>
6. The left and right screens appear misaligned when two screens (left and right) are displayed as one screen.	<ul style="list-style-type: none"> <li>The display timing may be off depending on the graphic card you are using.</li> </ul>

## 6-3. Other problems

Problem	Possible cause and remedy
1. The adjustment menu does not appear.	<ul style="list-style-type: none"> <li>• Check whether the operation lock function works (see “3-4. Locking Operation Switches” (page 16)).</li> </ul>
2. No mode menu is displayed.	<ul style="list-style-type: none"> <li>• Check whether the operation lock function works (see “3-4. Locking Operation Switches” (page 16)).</li> </ul>
3. The operation switches do not work.	<ul style="list-style-type: none"> <li>• Check whether the operation lock function works (see “3-4. Locking Operation Switches” (page 16)).</li> <li>• Check whether there are any water droplets or foreign objects on the switch surface. Gently wipe the switch surface and try operating the switches again with dry hands.</li> <li>• Are you wearing gloves? If so, remove the gloves and try operating the switches again with dry hands.</li> </ul>
<b>4. (When using Presence Sensor)</b> <b>The images remain to be displayed when you move away from the monitor. / The images do not reappear when you come near it.</b>	<ul style="list-style-type: none"> <li>• Check the setting environment of the monitor. Presence Sensor may not work correctly in the following environments. <ul style="list-style-type: none"> <li>- The monitor is located in a place affected by wind.</li> <li>- There is some heat emitting device near the monitor.</li> <li>- There is some obstacle in front of the sensor.</li> </ul> </li> <li>• Check whether any dirt on the sensor. Clean the sensor with a soft cloth.</li> <li>• Check whether you are in front of the monitor. The Presence Sensor function is activated when the sensor on the front of the monitor detects the movement of heat.</li> <li>• In the high temperature conditions, the monitor may not recover from the power saving mode. If the screen is not displayed even after moving the mouse or pressing any key on the keyboard, turn the monitor off and on using its power button. When the screen is displayed, increase the detection sensitivity value (see “5-3. Setting the power saving mode when a person leaves the monitor” (page 23)).</li> </ul>
<b>5. The monitor connected with the USB cable is not detected. / USB devices connected to the monitor do not work.</b>	<ul style="list-style-type: none"> <li>• Check whether the USB cable is connected correctly (see “7-4. Making Use of USB (Universal Serial Bus)” (page 32)).</li> <li>• Change the USB port to another one. If the PC or peripheral devices works correctly by changing the USB port, contact your local EIZO representative. (Refer to the manual of the PC for details.)</li> <li>• Reboot the PC.</li> <li>• If the peripheral devices work correctly when the PC and peripheral devices are connected directly, please contact your local EIZO representative.</li> <li>• Check whether the PC and OS are USB compliant. (For USB compliance of the respective devices, consult their manufacturers.)</li> <li>• Check the PC’s BIOS setting for USB when using Windows. (Refer to the manual of the PC for details.)</li> </ul>

Problem	Possible cause and remedy
<p><b>6. The power turns off during operation and no image is displayed.</b></p>	<ul style="list-style-type: none"> <li>• When the internal temperature is extremely high, the monitor and AC adapter turn off automatically. If the power switch is turned on again while the temperature remains high, the power turns off again in one minute.</li> <li>• Change the installation location or environment, and then turn it on again a few minutes later. <ul style="list-style-type: none"> <li>- The ventilation slot must not be closed.</li> <li>- There is no high temperature object around.</li> </ul> </li> <li>• If the power is not turned on even after the installation location or environment has changed, contact your local EIZO representative.</li> </ul> <p><b>Attention</b></p> <ul style="list-style-type: none"> <li>• Do not block the ventilation slots for the monitor or AC adapter, and do not use the monitor or AC adapter in a poorly-ventilated area.</li> </ul>
<p><b>7. The operation sound of the fan for the AC adapter is noticeable.</b></p>	<ul style="list-style-type: none"> <li>• The AC adapter is equipped with a fan to avoid rise in the internal temperature. The operation sound may be heard depending on the installation location. However, it is not a problem.</li> <li>• Change the installation location of the AC adapter or the orientation of the fan ventilation slot.</li> </ul>
<p><b>8. The Hybrid Gamma function cannot be used.</b></p>	<ul style="list-style-type: none"> <li>• Check whether the input resolutions of the left and right screens are the same.</li> <li>• This function can be used only when the input resolutions of the left and right screens are the same or the signals are input to either screen only.</li> </ul>
<p><b>9. SelfCalibration/Grayscale Check failure</b></p>	<ul style="list-style-type: none"> <li>• Refer to the error code table in the “Instructions for Use”.</li> <li>• If an error code that does not appear in the error code table is displayed, contact your local EIZO representative.</li> </ul> <p><b>Attention</b></p> <ul style="list-style-type: none"> <li>• Do not touch the Integrated Front Sensor.</li> </ul>
<p><b>10. Time is not displayed correctly in the history of SelfCalibration/Grayscale Check.</b></p>	<ul style="list-style-type: none"> <li>• Execute Monitor Detection using RadiCS/RadiCS LE. For details, refer to RadiCS/RadiCS LE User’s Manual.</li> </ul>

# Chapter 7 Reference

## 7-1. How to Attach the Arm

Another manufacturer's arm (or another manufacturer's stand) can be attached by removing the stand section of the monitor.

### Attention

- When attaching an arm or stand, follow the instructions of their User's Manual.
- When using another manufacturer's arm or stand, confirm the following in advance and select one conforming to the VESA standard.
  - Clearance between the screw holes: 100mm × 100mm
  - Strong enough to support weight of the monitor unit (except the stand) and attachments such as cables.
- Use the screws as described below.
  - Screws fixing the stand to the monitor
- When using an arm or stand, attach it to meet the following tilt angles of the monitor.
  - Up 45°, down 45°
- Connect the cables after attaching an arm or stand.
- Do not move the removed stand up and down. Doing so may result in injury or device damage.
- The monitor and arm or stand are heavy. Dropping them may result in injury or equipment damage.

### Procedure

**1. Lay the LCD monitor on a soft cloth spread over on a stable surface with the panel surface facing down.**

**2. Remove the stand.**

Prepare a screwdriver. Loosen the screws (four) securing the unit and the stand with the screwdriver.

**3. Attach the arm or stand to the monitor.**

Attach it using the screws removed in Step 2.

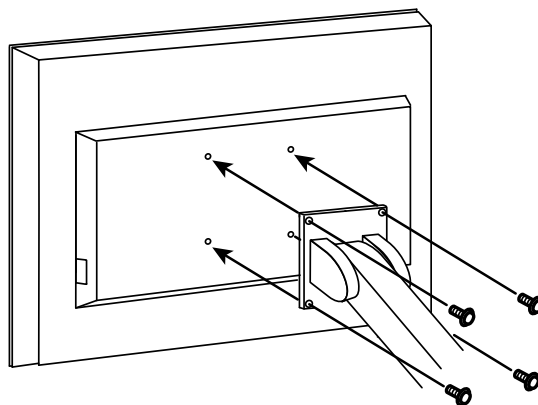

## 7-2. How to Install the Wall Mounting Device

The monitor and AC adapter can be attached to a wall mounting device.

### Attention

- Ask an installation contractor for the attachment.
- Prepare a wall mounting device separately.
- When installing a wall mounting device, follow the instructions of its User's Manual.
- Use the screws as described below.
  - Monitor: Screws fixing the stand to the monitor
  - AC adapter: Screws on the backside (3 pcs.)
- Attach the AC adapter in the correct orientation in accordance with the procedure.
- After the attachment of the AC adapter, be sure to tighten the screws on the backside.
- Connect the cables after attaching an arm or stand.
- Do not move the removed stand up and down. Doing so may result in injury or device damage.
- The monitor, AC adapter, and wall mounting device are heavy. Dropping them may result in injury or equipment damage.

### Procedure

**1. Lay the LCD monitor on a soft cloth spread over on a stable surface with the panel surface facing down.**

**2. Remove the stand.**

Prepare a screwdriver. Loosen the screws (four) securing the unit and the stand with the screwdriver.

**3. Install the wall mounting device and attach the monitor to it.**

Attach it using the screws removed in Step 2.

**4. Attach the AC adapter to the wall mounting device.**

Remove the three screws from the backside of the AC adapter.

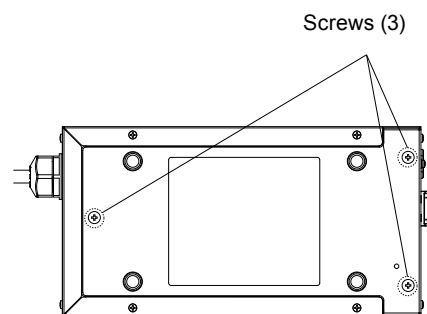

Attach the AC adapter as shown below using the screws removed. Do not attach the AC adapter in the wrong orientation.



## 7-3. Connecting Multiple PCs

The product has multiple connections to PCs and allows you to switch to one of the connections for display.

### Connection examples

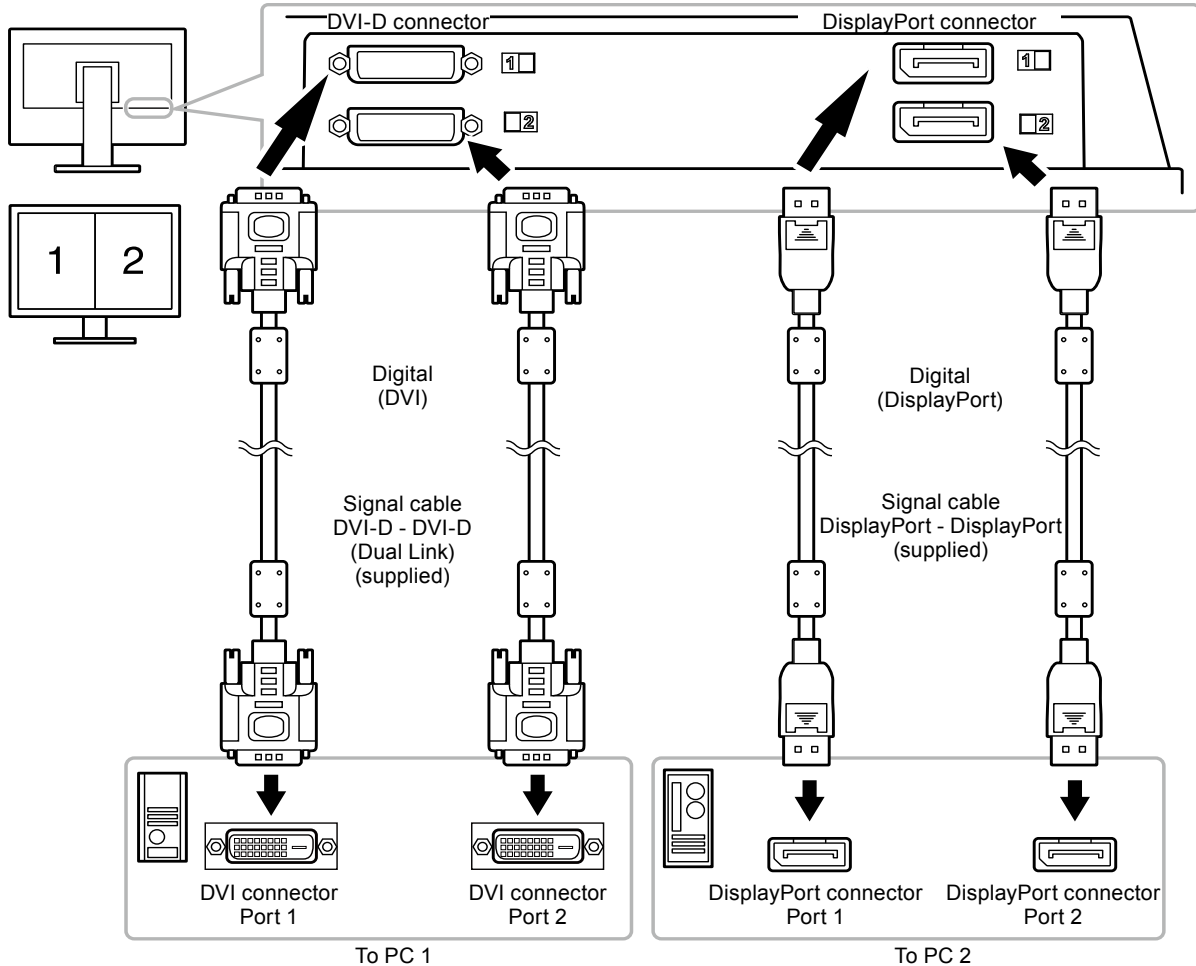

### ● To switch among input signals

#### Procedure

1. Choose "Tools" from the Adjustment menu, and choose **| ENTER |**.
2. Choose "Input" from "Tools", and choose **| ENTER |**.
3. Select "DVI - DVI", "DVI - DP", "DP - DP", or "DP - DVI" with **| ▲ |** or **| ▼ |**.
4. Choose **| ENTER |** to exit.

When the signal is switched, the active input port name appears at the top right corner of the screen.

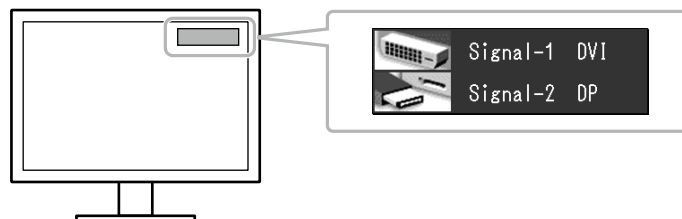

## ● To set input signal selection

Setting	Function
Auto	The monitor automatically identifies the connectors carrying computer input signals and displays the respective images on the left and right screens. ( Example: DisplayPort 1 - DisplayPort 2 / DisplayPort 1 - DVI 2 / DVI 1 - DisplayPort 2 / DVI 1 - DVI 2 ) When a PC is turned off or enters the power saving mode, the monitor automatically displays another signal.
Manual	The monitor detects only the PC's signals currently displaying automatically. Select an active input signal with "Input".

### **Procedure**

1. Choose "Tools" from the Adjustment menu, and choose | **ENTER** |.
2. Choose "Input Selection" from "Tools", and choose | **ENTER** |.
3. Select "Auto" or "Manual" with | ▲ | or | ▼ |.
4. Choose | **ENTER** | to exit.

---

### **Note**

- When "Auto" is selected for "Input Selection", the monitor's power saving function works only when all PCs are in the power saving mode.
-

## 7-4. Making Use of USB (Universal Serial Bus)

This monitor has a hub compatible with USB. Connected to a PC compatible with USB or another USB hub, this monitor functions as a USB hub allowing connection to peripheral USB devices.

### ● Required system environment

- A PC equipped with a USB port or another USB hub connected to a USB compatible PC
- Windows 2000/XP/Vista/7/8 or Mac OS 9.2.2 and Mac OS X 10.2 or later
- USB cable

#### Attention

- This monitor may not work depending on PC, OS or peripheral devices to be used. For USB compatibility of peripheral devices, contact their manufactures.
- When the monitor is in power saving mode, devices connected to the USB downstream port will still work. Therefore, power consumption of the monitor varies with connected devices even in the power saving mode.
- When the AC adapter main power switch is Off, device connected to the USB port will not operate.

### ● Connection procedure (Setup of USB function)

1. Connect the monitor first to a PC using the signal cable, and run the PC.
2. Connect the supplied USB cable between the USB downstream port of a USB compatible PC (or another USB hub) and the monitor's USB upstream port.  
The USB hub function is set up automatically upon connection of the USB cable.
3. Connect the peripheral USB device to the USB downstream port of the monitor.

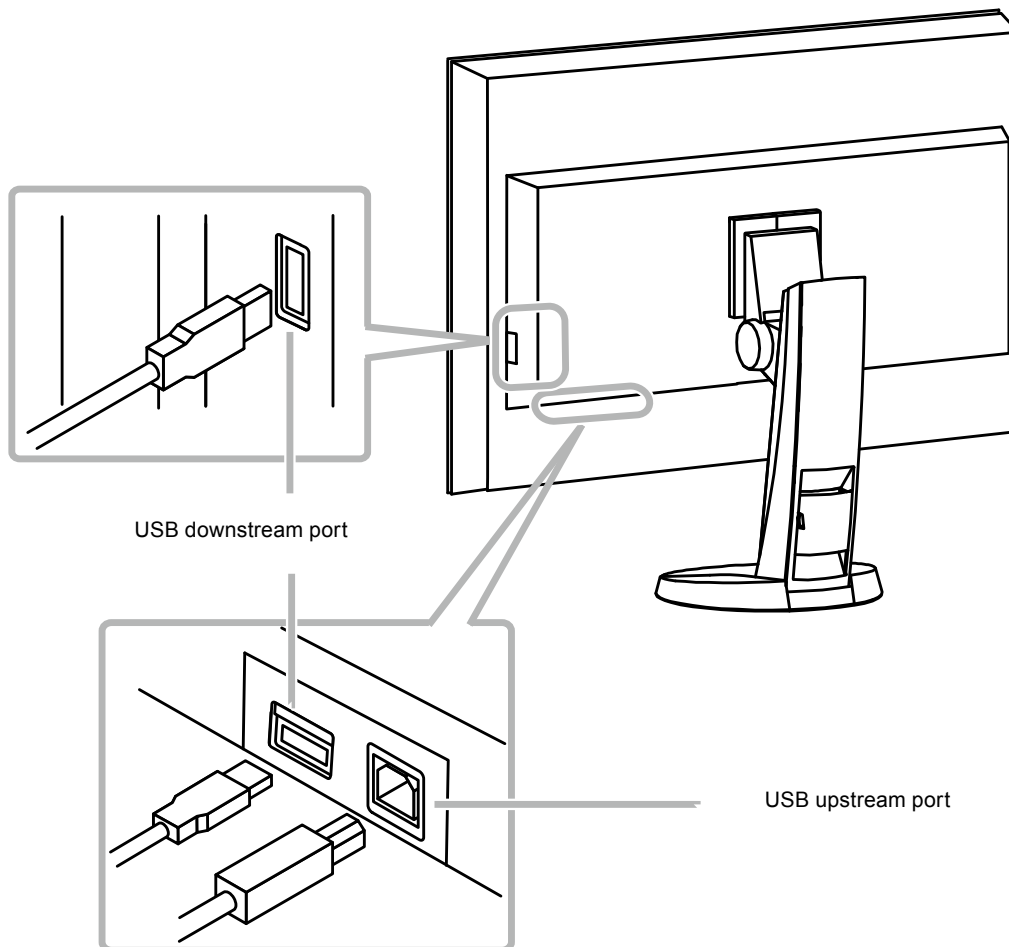



## 7-5. Displaying Monitor Information

### ● Displaying the signal information

This function displays the information about the current input signals displayed.

#### Procedure

1. Choose “Tools” from the Adjustment menu, and choose | **ENTER** |.
2. Choose “Signal Info” from “Tools”, and choose | **ENTER** |.

The “Signal Info” appears.

(Example)

```
Tools > Signal Info
Signal-1 DVI      Signal-2 DP
1280 X 1024      1280 X 1024
fD: 108.0MHz     fD: 108.0MHz
fH: 63.9kHz      fH: 63.9kHz
fV: 60.0Hz       fV: 60.0Hz
```

### ● Displaying monitor information

This function displays the information about the monitor.

#### Procedure

1. Choose “Tools” from the Adjustment menu, and choose | **ENTER** |.
2. Choose “Monitor Info” from “Tools”, and choose | **ENTER** |.

The “Monitor Info” appears.

This function displays the model name, serial number, firmware version, and usage time.

(Example)

```
Tools > Monitor Info
RadiForce RX650
S/N: 00000001
Version: 10000-10000-00000
Usage Time
Product:      1h
Backlight:    1h
```

---

#### Attention

- The usage time is not always “0” when you purchase the monitor due to factory inspection.
-

## 7-6. Main Default Settings

**CAL Switch Mode : The default display mode setting is 1-DICOM.**

### RX650

Mode	Brightness	Temperature	Gamma value
1-DICOM	400 cd/m <sup>2</sup>	7,500K	DICOM
2-Custom	Approx. 400 cd/m <sup>2</sup>	7,500K	2.2
3-CAL1	300 cd/m <sup>2</sup>	7,500K	DICOM
4-CAL2	300 cd/m <sup>2</sup>	7,500K	2.2
5-CAL3	400 cd/m <sup>2</sup>	6,500K	DICOM
6-sRGB	Approx. 250 cd/m <sup>2</sup>	6,500K	Standard
7-Text	Approx. 100 cd/m <sup>2</sup>	6,500K	2.2

### RX850

Mode	Brightness	Temperature	Gamma value
1-DICOM	500 cd/m <sup>2</sup>	7,500K	DICOM
2-Custom	Approx. 500 cd/m <sup>2</sup>	7,500K	2.2
3-CAL1	400 cd/m <sup>2</sup>	7,500K	DICOM
4-CAL2	400 cd/m <sup>2</sup>	7,500K	2.2
5-CAL3	500 cd/m <sup>2</sup>	6,500K	DICOM
6-sRGB	Approx. 250 cd/m <sup>2</sup>	6,500K	Standard
7-Text	Approx. 100 cd/m <sup>2</sup>	6,500K	2.2

### Others

Input* <sup>1</sup>	DVI-DVI
Presence Sensor	Off
Power Save	High
Input Selection	Auto
DDC* <sup>1</sup>	On
DC5V Output* <sup>1</sup>	Off
Resolution* <sup>1</sup>	RX650: Full RX850: 8MP
Grayscale Warning	On
Menu Position	Center
Language	English

\*<sup>1</sup> These functions cannot be initialized with the "All Reset" function (see [page 18](#)).

# Appendix

## LIMITED WARRANTY (RX650)

### LIMITED WARRANTY

EIZO Corporation (hereinafter referred to as “**EIZO**”) and distributors authorized by EIZO (hereinafter referred to as the “**Distributors**”) warrant, subject to and in accordance with the terms of this limited warranty (hereinafter referred to as the “**Warranty**”), to the original purchaser (hereinafter referred to as the “**Original Purchaser**”) who purchased the product specified in this document (hereinafter referred to as the “**Product**”) from EIZO or Distributors, that EIZO and Distributors shall, at their sole discretion, either repair or replace the Product at no charge if the Original Purchaser becomes aware within the Warranty Period (defined below) that (i) the Product malfunctions or is damaged in the course of normal use of the Product in accordance with the description in the instruction manual attached to the Product (hereinafter referred to as the “**User’s Manual**”), or (ii) the LCD panel and brightness of the Product cannot maintain the recommended brightness specified in the User’s Manual in the course of normal use of the Product in accordance with the description of the User’s Manual.

The period of this Warranty is five (5) years from the date of purchase of the Product (hereinafter referred to as the “**Warranty Period**”), provided that the brightness of the Product shall be warranted only if the Product has been used within the recommended brightness described in the User’s Manual and the Warranty Period for the brightness is limited to five (5) years from the date of purchase of the Product subject to the usage time being less than or equal to 20,000 hours (the brightness is 400 cd/m<sup>2</sup> and color temperature is 7500K) or less than or equal to 30,000 hours (the brightness is 300 cd/m<sup>2</sup> and color temperature is 7500K). EIZO and Distributors shall bear no liability or obligation with regard to the Product in relation to the Original Purchaser or any third parties other than as provided under this Warranty.

EIZO and Distributors will cease to hold or store any parts of the Product upon expiration of seven (7) years after the production of such parts is discontinued. In repairing the monitor, EIZO and Distributors will use renewal parts which comply with our QC standards.

The Warranty is valid only in the countries or territories where the Distributors are located. The Warranty does not restrict any legal rights of the Original Purchaser.

Notwithstanding any other provision of this Warranty, EIZO and Distributors shall have no obligation under this Warranty whatsoever in any of the cases as set forth below:

- (a) Any defect of the Product caused by freight damage, modification, alteration, abuse, misuse, accident, incorrect installation, disaster, faulty maintenance and/or improper repair by third party other than EIZO and Distributors;
- (b) Any incompatibility of the Product due to possible technical innovations and/or regulations;
- (c) Any deterioration of the sensor;
- (d) Any deterioration of display performance caused by the deterioration of expendable parts such as the LCD panel and/or backlight, etc. (e.g. changes in color, changes in color uniformity, defects in pixels including burnt pixels, etc.);
- (e) Any deterioration of the Product caused by the use at higher brightness than the recommended brightness described in the User’s Manual;
- (f) Any defect of the Product caused by external equipment;
- (g) Any defect of the Product on which the original serial number has been altered or removed;
- (h) Any normal deterioration of the product, particularly that of consumables, accessories, and/or attachments (e.g. buttons, rotating parts, cables, User’s Manual, etc.); and
- (i) Any deformation, discoloration, and/or warp of the exterior of the product including that of the surface of the LCD panel.

To obtain service under the Warranty, the Original Purchaser must deliver the Product, freight prepaid, in its original package or other adequate package affording an equal degree of protection, assuming the risk of damage and/or loss in transit, to the local Distributor. The Original Purchaser must present proof of purchase of the Product and the date of such purchase when requesting services under the Warranty.

The Warranty Period for any replaced and/or repaired product under this Warranty shall expire at the end of the original Warranty Period.

EIZO OR DISTRIBUTORS ARE NOT RESPONSIBLE FOR ANY DAMAGE TO, OR LOSS OF, DATA OR OTHER INFORMATION STORED IN ANY MEDIA OR ANY PART OF ANY PRODUCT RETURNED TO EIZO OR DISTRIBUTORS FOR REPAIR.

EIZO AND DISTRIBUTORS MAKE NO FURTHER WARRANTIES, EXPRESSED OR IMPLIED, WITH RESPECT TO THE PRODUCT AND ITS QUALITY, PERFORMANCE, MERCHANTABILITY OR FITNESS FOR ANY PARTICULAR USE. IN NO EVENT SHALL EIZO OR DISTRIBUTORS BE LIABLE FOR ANY INCIDENTAL, INDIRECT, SPECIAL, CONSEQUENTIAL OR OTHER DAMAGE WHATSOEVER (INCLUDING, WITHOUT LIMITATION, DAMAGES FOR LOSS OF PROFIT, BUSINESS INTERRUPTION, LOSS OF BUSINESS INFORMATION, OR ANY OTHER PECUNIARY LOSS) ARISING OUT OF THE USE OR INABILITY TO USE THE PRODUCT OR IN ANY CONNECTION WITH THE PRODUCT, WHETHER BASED ON CONTRACT, TORT, NEGLIGENCE, STRICT LIABILITY OR OTHERWISE, EVEN IF EIZO OR DISTRIBUTORS HAVE BEEN ADVISED OF THE POSSIBILITY OF SUCH DAMAGES. THIS EXCLUSION ALSO INCLUDES ANY LIABILITY WHICH MAY ARISE OUT OF THIRD PARTY CLAIMS AGAINST THE ORIGINAL PURCHASER. THE ESSENCE OF THIS PROVISION IS TO LIMIT THE POTENTIAL LIABILITY OF EIZO AND DISTRIBUTORS ARISING OUT OF THIS LIMITED WARRANTY AND/OR SALES.

## BEGRENZTE GARANTIE

EIZO Corporation (im Weiteren als „**EIZO**“ bezeichnet) und die Vertragsimporteure von EIZO (im Weiteren als „**Vertrieb(e)**“ bezeichnet) garantieren dem ursprünglichen Käufer (im Weiteren als „**Erstkäufer**“ bezeichnet), der das in diesem Dokument vorgegebene Produkt (im Weiteren als „**Produkt**“ bezeichnet) von EIZO oder einem Vertrieb erworben hat, gemäß den Bedingungen dieser beschränkten Garantie (im Weiteren als „**Garantie**“ bezeichnet), dass EIZO und der Vertrieb nach eigenem Ermessen das Produkt entweder kostenlos reparieren oder austauschen, falls der Erstkäufer innerhalb der Garantiefrist (weiter unten festgelegt) entweder (i) eine Fehlfunktion bzw. Beschädigung des Produkts feststellt, die während des normalen Gebrauchs des Produkts gemäß den Anweisungen des zum Lieferumfang des Produkts gehörenden Benutzerhandbuchs (im Weiteren als „**Benutzerhandbuch**“ bezeichnet) aufgetreten ist, oder (ii) das LCD-Panel und die Helligkeit des Produkts während des normalen Gebrauchs des Produkts gemäß den Anweisungen des Benutzerhandbuchs nicht die im Benutzerhandbuch genannte empfohlene Helligkeit aufrecht erhalten können.

Die Dauer der Garantieleistung beträgt fünf (5) Jahre ab dem Kaufdatum des Produkts (im Weiteren als „Garantiefrist“ bezeichnet), wobei vorausgesetzt wird, dass die Helligkeit des Produkts nur garantiert wird, wenn das Produkt innerhalb der empfohlenen Helligkeit, wie im Benutzerhandbuch beschrieben, verwendet wird, und die Dauer der Garantiefrist für die Helligkeit beträgt fünf (5) Jahre ab dem Kaufdatum des Produkts, wobei die Nutzungszeit des Produkts auf maximal 20.000 Betriebsstunden (bei einer Helligkeit von 400 cd/m<sup>2</sup> und einer Farbtemperatur von 7500 K) oder maximal 30.000 Betriebsstunden (bei einer Helligkeit von 300 cd/m<sup>2</sup> und einer Farbtemperatur von 7500 K) beschränkt ist. EIZO und die Vertriebe übernehmen über den Rahmen dieser Garantie hinaus hinsichtlich des Produkts keinerlei Haftung oder Verpflichtung dem Erstkäufer oder Dritten gegenüber.

EIZO und die Vertriebe verpflichten sich, Ersatzteile für das Produkt über einen Zeitraum von sieben (7) Jahren nach Einstellung der Produktion der Ersatzteile zu lagern bzw. anzubieten. EIZO und seine Vertriebspartner verpflichten sich, bei einer etwaigen Reparatur des Monitors ausschließlich Produkte gemäß den EIZO-Qualitätssicherungsstandards zu verwenden.

Diese Garantie gilt nur in Ländern oder Gebieten, in denen sich Vertriebe befinden. Die gesetzlichen Gewährleistungsrechte des Erstkäufers gegenüber dem Verkäufer werden durch diese Garantie nicht berührt.

EIZO und die Vertriebe besitzen im Rahmen dieser Garantie keinerlei Verpflichtung in den folgenden Fällen:

- (a) Produktdefekte, die auf Frachtschäden, Modifikation, Nachgestaltung, Missbrauch, Fehlbedienung, Unfälle, unsachgemäße Installation, Naturkatastrophen, fehlerhafte Wartung und/oder unsachgemäße Reparatur durch eine andere Partei als EIZO und die Vertriebe zurückzuführen sind.
- (b) Eine Inkompatibilität des Produkts aufgrund von technischen Neuerungen und/oder neuen Bestimmungen, die nach dem Kauf in Kraft treten.
- (c) Jegliche Verschlechterung des Sensors;
- (d) Jegliche Verschlechterung der Bildschirmleistung, die durch Verschleißteile wie den LCD-Panel und/oder die Hintergrundbeleuchtung usw. hervorgerufen werden (z.B. Veränderungen von Farbe oder Farbverteilung, Pixeldefekte einschließlich von durchgebrannten Pixeln usw.).
- (e) Jegliche Abnutzung des Produkts, die auf einen Gebrauch mit einer höheren Helligkeit als die im Benutzerhandbuch genannte empfohlene Helligkeit zurückzuführen ist.
- (f) Produktdefekte, die durch externe Geräte verursacht werden.
- (g) Jeglicher Defekt eines Produkts, dessen ursprüngliche Seriennummer geändert oder entfernt wurde.
- (h) Normale Abnutzung des Produkts, insbesondere von Verbrauchsteilen, Zubehörteilen und/oder Beilagen (z.B. Tasten, drehbare Teile, Kabel, Benutzerhandbuch usw.); sowie
- (i) Verformungen, Verfärbungen und/oder Verziehungen am Produktäußeren, einschließlich der Oberfläche des LCD-Panels.

Bei Inanspruchnahme der Garantieleistung ist der Erstkäufer verpflichtet, das Produkt auf eigene Kosten und in der Originalverpackung bzw. einer anderen geeigneten Verpackung, die einen gleichwertigen Schutz gegen Transportschäden bietet, an den örtlichen Vertrieb zu übersenden, wobei der Erstkäufer das Transportrisiko gegenüber Schäden und/oder Verlust trägt. Zum Zeitpunkt der Inanspruchnahme der Garantieleistung muss der Erstkäufer einen Verkaufsbeleg vorweisen, auf dem das Kaufdatum angegeben ist.

Die Garantiefrist für ein im Rahmen dieser Garantie ausgetauschtes und/oder repariertes Produkt erlischt nach Ablauf der ursprünglichen Garantiefrist.

EIZO ODER DIE EIZO-VERTRAGSIMPORTEURE HAFTEN NICHT FÜR ZERSTÖRTE DATENBESTÄNDE ODER DIE KOSTEN DER WIEDERBESCHAFFUNG DIESER DATENBESTÄNDE AUF JEDLICHEN DATENTRÄGERN ODER TEILEN DES PRODUKTS, DIE IM RAHMEN DER GARANTIE BEI EIZO ODER DEN EIZO-VERTRAGSIMPORTEUREN ZUR REPARATUR EINGEREICHT WURDEN.

EIZO UND DIE EIZO-VERTRAGSIMPORTEURE GEBEN WEDER EXPLIZITE NOCH IMPLIZITE GARANTIE IN BEZUG AUF DIESES PRODUKT UND SEINE QUALITÄT, LEISTUNG, VERKÄUFLICHKEIT ODER EIGNUNG FÜR EINEN BESTIMMTEN ZWECK. AUF KEINEN FALL SIND EIZO ODER DIE EIZO-VERTRAGSIMPORTEURE VERANTWORTLICH FÜR JEDLICHE ZUFÄLLIGE, INDIREKTE, SPEZIELLE, FOLGE- ODER ANDERE SCHÄDEN JEDLICHER ART (EINSCHLIESSLICH OHNE JEDE BEGRENZUNG SCHÄDEN BEZÜGLICH PROFITVERLUST, GESCHÄFTSUNTERBRECHUNG, VERLUST VON GESCHÄFTSINFORMATION ODER JEDLICHE ANDEREN FINANZIELLEN EINBUSSEN), DIE DURCH DIE VERWENDUNG DES PRODUKTES ODER DIE UNFÄHIGKEIT ZUR VERWENDUNG DES PRODUKTES ODER IN JEDLICHER BEZIEHUNG MIT DEM PRODUKT, SEI ES BASIEREND AUF VERTRAG, SCHADENSERSATZ, NACHLAESSIGKEIT, STRIKTE HAFTPFLICHT ODER ANDEREN FORDERUNGEN ENTSTEHEN, AUCH WENN EIZO UND DIE EIZO-VERTRAGSIMPORTEURE IM VORAUS ÜBER DIE MÖGLICHKEIT SOLCHER SCHÄDEN INFORMIERT WURDEN. DIESER AUSSCHLUSS ENTHÄLT AUCH JEDE HAFTPFLICHT, DIE AUS FORDERUNGEN DRITTER GEGEN DEN ERSTKÄUFER ENTSTEHEN KANN. ZWECK DIESER KLAUSEL IST ES, DIE HAFTUNG VON EIZO UND DEN VERTRIEBEN GEGENÜBER FORDERUNGEN ZU BEGRENZEN, DIE AUS DIESER BESCHRÄNKTEN GARANTIE UND/ODER DEM VERKAUF ENTSTEHEN KÖNNEN.

## GARANTIE LIMITÉE

EIZO Corporation (ci-après dénommé « **EIZO** ») et les distributeurs autorisés par EIZO (ci-après dénommés « **Distributeurs** »), sous réserve et conformément aux termes de cette garantie limitée (ci-après dénommée « **Garantie** »), garantissent à l'acheteur initial (ci-après dénommé « **Acheteur initial** ») du produit spécifié dans la présente (ci-après dénommé « **Produit** ») acheté auprès d'EIZO ou de Distributeurs agréés EIZO, que EIZO et ses Distributeurs auront pour option de réparer ou remplacer gratuitement le Produit si l'Acheteur initial constate, pendant la Période de garantie (définie ci-dessous), (i) qu'il y a un dysfonctionnement ou que le Produit a subi un dommage dans le cadre d'une utilisation normale du Produit conformément à la description du mode d'emploi qui accompagne le Produit (ci-après dénommé « **Manuel d'utilisateur** »), ou (ii) que le panneau LCD et la luminosité du Produit ne peuvent pas maintenir la luminosité recommandée spécifiée dans le Manuel d'utilisation dans le cadre d'une utilisation normale du Produit, conformément à la description du Manuel d'utilisation.

La période de cette Garantie est limitée à cinq (5) ans à partir de la date d'achat du Produit (ci-après dénommée « Période de Garantie »), sous réserve que la luminosité du Produit ne sera garantie que si le Produit a été utilisé conformément à la luminosité recommandée dans le Manuel d'Utilisation et la Période de Garantie en matière de luminosité est limitée à cinq (5) ans à compter de la date d'achat du Produit, sous réserve que la durée d'utilisation soit inférieure ou égale à 20 000 heures (la luminosité est de 400 cd/m<sup>2</sup> et la température de la couleur à 7500 K) ou inférieure ou égale à 30 000 heures (la luminosité est de 300 cd/m<sup>2</sup> et la température de la couleur à 7500 K). EIZO et ses Distributeurs déclinent toute responsabilité ou obligation concernant ce Produit face à l'Acheteur initial ou à toute autre personne à l'exception de celles stipulées dans la présente Garantie.

EIZO et ses Distributeurs cesseront de tenir ou conserver en stock toute pièce de ce Produit après l'expiration de la période de sept (7) ans suivant l'arrêt de la production de telles pièces. Pour réparer le moniteur, EIZO et ses distributeurs utiliseront des pièces de rechange conformes à nos normes de contrôle qualité.

La Garantie est valable uniquement dans les pays ou les territoires où se trouvent les Distributeurs. La Garantie ne limite aucun des droits reconnus par la loi à l'Acheteur initial.

Nonobstant toute autre clause de cette Garantie, EIZO et ses Distributeurs n'auront d'obligation dans le cadre de cette Garantie pour aucun des cas énumérés ci-dessous :

- (a) Tout défaut du Produit résultant de dommages occasionnés lors du transport, d'une modification, d'une altération, d'un abus, d'une mauvaise utilisation, d'un accident, d'une installation incorrecte, d'un désastre, d'un entretien et/ou d'une réparation incorrects effectués par une personne autre que EIZO ou ses Distributeurs ;
- (b) Toute incompatibilité du Produit résultant d'améliorations techniques et/ou réglementations possibles ;
- (c) Toute détérioration du capteur ;
- (d) Toute détérioration des performances d'affichage causée par la détérioration des éléments consommables tels que le panneau LCD et/ou le rétroéclairage, etc. (par exemple, des changements de couleur, des changements de l'uniformité des couleurs, des défauts de pixels, y compris des pixels brûlés, etc.) ;
- (e) Toute détérioration du Produit causée par l'utilisation d'une luminosité plus élevée que la luminosité recommandée, telle que décrite dans le Manuel d'utilisation ;
- (f) Tout défaut du Produit causé par un appareil externe ;
- (g) Tout défaut d'un Produit sur lequel le numéro de série original a été altéré ou supprimé ;
- (h) Toute détérioration normale du Produit, particulièrement celle des consommables, des accessoires et/ou des pièces reliées au Produit (touches, éléments pivotants, câbles, Manuel d'utilisation etc.), et
- (i) Toute déformation, décoloration, et/ou gondolage de l'extérieur du Produit, y compris celle de la surface du panneau LCD.

Pour bénéficier d'un service dans le cadre de cette Garantie, l'Acheteur initial doit renvoyer le Produit port payé, dans son emballage d'origine ou tout autre emballage approprié offrant un degré de protection équivalent, au Distributeur local, et assumera la responsabilité des dommages et/ou perte possibles lors du transport. L'Acheteur initial doit présenter une preuve d'achat du Produit comprenant sa date d'achat pour bénéficier de ce service dans le cadre de la Garantie.

La Période de garantie pour tout Produit remplacé et/ou réparé dans le cadre de cette Garantie expirera à la fin de la Période de garantie initiale.

EIZO OU SES DISTRIBUTEURS NE SAURAIENT ÊTRE TENUS RESPONSABLES DES DOMMAGES OU PERTES DE DONNÉES OU D'AUTRES INFORMATIONS STOCKÉES DANS UN MÉDIA QUELCONQUE OU UNE AUTRE PARTIE DU PRODUIT RENVOYÉ À EIZO OU AUX DISTRIBUTEURS POUR RÉPARATION.

AUCUNE AUTRE GARANTIE, EXPLICITE OU TACITE, N'EST OFFERTE PAR EIZO ET SES DISTRIBUTEURS CONCERNANT LE PRODUIT ET SES QUALITÉS, PERFORMANCES, QUALITÉ MARCHANDE OU ADAPTATION À UN USAGE PARTICULIER. EN AUCUN CAS, EIZO OU SES DISTRIBUTEURS NE SERONT RESPONSABLES DES DOMMAGES FORTUITS, INDIRECTS, SPÉCIAUX, INDUITS, OU DE TOUT AUTRE DOMMAGE QUEL QU'IL SOIT (Y COMPRIS, SANS LIMITATION, LES DOMMAGES RÉSULTANT D'UNE PERTE DE PROFIT, D'UNE INTERRUPTION D'ACTIVITÉS, D'UNE PERTE DE DONNÉES COMMERCIALES, OU DE TOUT AUTRE MANQUE À GAGNER) RÉSULTANT DE L'UTILISATION OU DE L'INCAPACITÉ D'UTILISER LE PRODUIT OU AYANT UN RAPPORT QUELCONQUE AVEC LE PRODUIT, QUE CE SOIT SUR LA BASE D'UN CONTRAT, D'UN TORT, D'UNE NÉGLIGENCE, D'UNE RESPONSABILITÉ STRICTE OU AUTRE, MÊME SI EIZO OU SES DISTRIBUTEURS ONT ÉTÉ AVERTIS DE LA POSSIBILITÉ DE TELS DOMMAGES. CETTE LIMITATION INCLUT AUSSI TOUTE RESPONSABILITÉ QUI POURRAIT ÊTRE SOULEVÉE LORS DES RÉCLAMATIONS D'UN TIERS CONTRE L'ACHETEUR INITIAL. L'ESSENCE DE CETTE CLAUSE EST DE LIMITER LA RESPONSABILITÉ POTENTIELLE DE EIZO ET DE SES DISTRIBUTEURS RÉSULTANT DE CETTE GARANTIE LIMITÉE ET/OU DES VENTES.

## GARANTÍA LIMITADA

EIZO Corporation (en lo sucesivo “EIZO”) y sus distribuidores autorizados por EIZO (en lo sucesivo los “Distribuidores”), con arreglo y de conformidad con los términos de esta garantía limitada (en lo sucesivo la “Garantía”), garantizan al comprador original (en lo sucesivo el “Comprador original”) que compró el producto especificado en este documento (en lo sucesivo el “Producto”) a EIZO o a sus Distribuidores, que EIZO y sus Distribuidores, a su propio criterio, repararán o sustituirán el Producto de forma gratuita si el Comprador original detecta dentro del periodo de la Garantía (indicado posteriormente) que: (i) el Producto no funciona correctamente o que se ha averiado durante el uso normal del mismo de acuerdo con las indicaciones del manual de instrucciones suministrado con el Producto (en lo sucesivo el “Manual del usuario”); o (ii) el panel LCD y el brillo del Producto no pueden mantener el brillo recomendado que se especifica en el Manual del usuario durante el uso normal del Producto de acuerdo con las descripciones del Manual del usuario.

El período de validez de esta Garantía es de cinco (5) años a contar desde la fecha de compra del Producto (en adelante, “Período de garantía”), teniendo en cuenta que el brillo del Producto sólo estará cubierto por la garantía si el Producto se ha utilizado con el brillo recomendado que se describe en el Manual del usuario, y que el Período de garantía está limitado a cinco (5) años a partir de la fecha de compra del Producto, siempre que el tiempo de uso sea inferior o igual a 20.000 horas (siendo el brillo de 400cd/m<sup>2</sup> y la temperatura de color de 7500K) o inferior o igual a 30.000 horas (siendo el brillo de 300cd/m<sup>2</sup> y la temperatura de color de 7500K). EIZO y sus Distribuidores no tendrán ninguna responsabilidad ni obligación con respecto al Producto para con el Comprador original ni con terceros que no sean las estipuladas en la presente Garantía.

EIZO y sus Distribuidores no estarán obligados a suministrar cualquier recambio del Producto una vez pasados siete (7) años desde que se deje de fabricar el mismo. Para la reparación del monitor, EIZO y los distribuidores utilizarán repuestos que cumplan con nuestros estándares de control de calidad.

La Garantía es válida sólo en los países y territorios donde están ubicados los Distribuidores. La Garantía no restringe ningún derecho legal del Comprador original.

A pesar de las estipulaciones de esta Garantía, EIZO y sus Distribuidores no tendrán obligación alguna bajo esta Garantía en ninguno de los casos expuestos a continuación:

- (a) Cualquier defecto del Producto causado por daños en el transporte, modificación, alteración, abuso, uso incorrecto, accidente, instalación incorrecta, desastre, mantenimiento incorrecto y/o reparación indebida realizada por un tercero que no sea EIZO o sus Distribuidores.
- (b) Cualquier incompatibilidad del Producto debida a posibles innovaciones técnicas y/o reglamentaciones.
- (c) Cualquier deterioro del sensor;
- (d) Cualquier deterioro en el rendimiento de la visualización causado por fallos en las piezas consumibles como el panel de cristal líquido y/o la luz de fondo, etc. (p.ej. cambios de color, cambios de uniformidad del color, defectos de píxeles, incluyendo píxeles muertos, etc.).
- (e) Cualquier deterioro del Producto causado por el uso continuado con un brillo superior al recomendado en el Manual del usuario.
- (f) Cualquier defecto del Producto causado por un equipo externo.
- (g) Cualquier defecto del Producto en el que haya sido alterado o borrado el número de serie original.
- (h) Cualquier deterioro normal del Producto, y en particular de las piezas consumibles, accesorios y demás (p. ej. botones, piezas giratorias, cables, Manual del usuario, etc.).
- (i) Cualquier deformación, decoloración y/o alabeo del exterior del Producto incluida la superficie del panel LCD.

Para obtener servicio en los términos de esta Garantía, el Producto deberá ser enviado por el Comprador original, a su Distribuidor local, con el transporte previamente pagado, en el embalaje original u otro embalaje adecuado que ofrezca el mismo grado de protección, asumiendo el riesgo de daños y/o pérdida del Producto durante el transporte. El Comprador original deberá presentar un comprobante de compra del Producto en el que se refleje la fecha de compra del mismo cuando lo solicite el servicio de Garantía.

El Período de garantía para cualquier Producto reemplazado y/o reparado en los términos de esta Garantía expirará al vencer el Período de garantía original.

EIZO O LOS DISTRIBUIDORES AUTORIZADOS DE EIZO NO SE RESPONSABILIZAN DE NINGÚN DAÑO O PÉRDIDA QUE PUEDAN SUFRIR LOS DATOS U OTRA INFORMACIÓN ALMACENADA EN CUALQUIER MEDIO O CUALQUIER PARTE DE CUALQUIER PRODUCTO DEVUELTO A EIZO O A LOS DISTRIBUIDORES DE EIZO PARA SU REPARACIÓN.

EIZO Y LOS DISTRIBUIDORES AUTORIZADOS DE EIZO NO OFRECEN NINGUNA OTRA GARANTÍA, IMPLÍCITA NI EXPLÍCITA, CON RESPECTO AL PRODUCTO Y A SU CALIDAD, RENDIMIENTO, COMERCIALIZACIÓN E IDONEIDAD PARA CUALQUIER USO EN PARTICULAR. EN NINGÚN CASO SERÁN EIZO O LOS DISTRIBUIDORES AUTORIZADOS DE EIZO RESPONSABLES DE NINGÚN DAÑO EMERGENTE, INDIRECTO, ESPECIAL, INHERENTE O CUALQUIERA QUE SEA (INCLUYENDO, SIN LIMITACIÓN, DAÑOS POR LUCRO CESANTE, INTERRUPCIÓN DE LA ACTIVIDAD COMERCIAL, PÉRDIDA DE INFORMACIÓN COMERCIAL O CUALQUIER OTRA PÉRDIDA PECUNIARIA) QUE SE DERIVE DEL USO O IMPOSIBILIDAD DE USO DEL PRODUCTO O EN RELACIÓN CON EL PRODUCTO, YA SEA BASADO EN CONTRATO, POR AGRAVIO, NEGLIGENCIA, ESTRICTA RESPONSABILIDAD O CUALQUIERA QUE SEA, AUN CUANDO SE HAYA ADVERTIDO A EIZO O A LOS DISTRIBUIDORES DE EIZO DE LA POSIBILIDAD DE TALES DAÑOS. ESTA EXCLUSIÓN TAMBIÉN ABARCA CUALQUIER RESPONSABILIDAD QUE PUEDA DERIVARSE DE RECLAMACIONES HECHAS POR UN TERCERO CONTRA EL COMPRADOR ORIGINAL. LA ESENCIA DE ESTA ESTIPULACIÓN ES LIMITAR LA RESPONSABILIDAD POTENCIAL DE EIZO Y LOS DISTRIBUIDORES QUE PUDIERA DERIVARSE DE ESTA GARANTÍA LIMITADA Y/O VENTAS.



## GARANZIA LIMITATA

EIZO Corporation (a cui si farà riferimento da qui in poi con “**EIZO**”) ed i Distributori autorizzati da EIZO (a cui si farà riferimento da qui in poi con “**Distributori**”) garantiscono, secondo i termini di questa garanzia limitata (a cui si farà riferimento da qui in poi con “**Garanzia**”) all’acquirente originale (a cui si farà riferimento da qui in poi con “**Acquirente originale**”) che ha acquistato il prodotto specificato in questo documento (a cui si farà riferimento da qui in poi con “**Prodotto**”) da EIZO o dai suoi Distributori, che EIZO e i distributori, a loro discrezione, ripareranno o sostituiranno il Prodotto senza addebito se l’Acquirente originale trova, entro il periodo della Garanzia (definito sotto), che (i) il Prodotto malfunziona e si è danneggiato nel corso del suo normale utilizzo osservando le indicazioni del manuale di istruzioni allegato al Prodotto (a cui si farà riferimento da qui in poi con “**Manuale utente**”), o che (ii) il pannello LCD e la luminosità del Prodotto non possono mantenere la luminosità raccomandata specificata nel Manuale utente nel corso del normale utilizzo del Prodotto osservando le indicazioni del Manuale utente.

La presente Garanzia ha una validità di cinque (5) anni dalla data dell’acquisto del Prodotto (di qui in avanti “Periodo di Garanzia”), considerando che la luminosità del Prodotto sarà garantita solo se il Prodotto è stato utilizzato con la luminosità consigliata descritta nel Manuale utente e che il Periodo di garanzia per la luminosità è limitato a cinque (5) anni dalla data di acquisto del Prodotto, a condizione che il tempo di utilizzo sia inferiore o uguale a 20.000 ore (luminosità di 400cd/m<sup>2</sup> e temperatura colore di 7.500K) o inferiore o uguale a 30.000 ore (luminosità di 300cd/m<sup>2</sup> e temperatura colore di 7.500K). EIZO e i suoi Distributori non si assumono alcuna responsabilità e non hanno alcun obbligo riguardo al Prodotto verso l’Acquirente originale o terzi diversi da quelli relativi a questa Garanzia.

EIZO e i suoi Distributori cesseranno di tenere o di conservare qualsiasi ricambio del Prodotto allo scadere di sette (7) anni dopo che la produzione di tali ricambi è stata terminata. Per la riparazione del monitor, EIZO e i Distributori utilizzeranno parti di ricambio conformi ai nostri standard di controllo della qualità.

La Garanzia è valida soltanto nei paesi dove ci sono i Distributori EIZO. La Garanzia non limita alcun diritto legale dell’Acquirente originale.

Indipendentemente da qualsiasi altra condizione di questa Garanzia, EIZO e i suoi Distributori non avranno alcun obbligo derivante da questa Garanzia in ognuno dei casi elencati di seguito:

- (a) Qualsiasi difetto del Prodotto causato da danni di trasporto, modifiche, alterazioni, abusi, usi impropri, incidenti, installazione errata, calamità, manutenzione errata e/o riparazioni improprie eseguite da terze parti che non siano EIZO o i suoi Distributori.
- (b) Qualsiasi incompatibilità del Prodotto dovuta a possibili innovazioni tecniche e/o normative.
- (c) Qualsiasi deterioramento del sensore;
- (d) Qualsiasi deterioramento delle prestazioni dello schermo causato dal deterioramento delle parti consumabili, come il pannello LCD e/o la retroilluminazione, ecc. (per esempio: i cambiamenti di colore, cambiamenti di uniformità del colore, difetti dei pixel, inclusi i pixel bruciati, ecc.).
- (e) Qualsiasi deterioramento del Prodotto causato dal suo utilizzo ad una luminosità più alta di quella raccomandata nel Manuale utente.
- (f) Qualsiasi difetto del Prodotto causato da apparecchiature esterne.
- (g) Qualsiasi difetto del Prodotto in cui il numero di serie originale sia stato alterato o rimosso.
- (h) Qualsiasi normale deterioramento del Prodotto, in particolar modo nelle sue parti di consumo, accessori, e/o attacchi (per esempio: tasti, parti rotanti, cavi, Manuale dell’utente, ecc.).
- (i) Qualsiasi tipo di deformazione, scolorimento, e/o di involucro esterno del Prodotto inclusa la superficie del pannello LCD.

Per ricevere assistenza tecnica con questa Garanzia, l’Acquirente originale deve inviare il Prodotto, con trasporto pre-pagato, nella sua confezione originale o altra confezione adeguata che fornisce un livello analogo di protezione, assumendosi il rischio di danni e/o perdita in transito, al Distributore locale. L’Acquirente originale deve presentare la prova di acquisto che stabilisce la data di acquisto del Prodotto quando richiede servizio sotto Garanzia.

Il Periodo di garanzia per qualsiasi Prodotto sostituito e/o riparato sotto questa Garanzia scade alla fine del Periodo di garanzia originale.

EIZO O I SUOI DISTRIBUTORI NON SONO RESPONSABILI PER QUALSIASI DANNO O PERDITA DI DATI O ALTRE INFORMAZIONI MEMORIZZATI SU QUALSIASI SUPPORTO O QUALSIASI PARTE DI QUALSIASI PRODOTTO INVIATO A EIZO O I SUOI DISTRIBUTORI PER RIPARAZIONI.

EIZO E I SUOI DISTRIBUTORI NON OFFRONO ALCUNA GARANZIA ADDIZIONALE, IMPLICITA O ESPLICITA, RIGUARDO IL PRODOTTO E LA SUA QUALITÀ, PRESTAZIONI, VENDIBILITÀ O APPROPRIATEZZA PER QUALSIASI USO PARTICOLARE. IN NESSUN CASO EIZO O I DISTRIBUTORI EIZO AUTORIZZATI SARANNO RESPONSABILI PER QUALSIASI DANNO ACCIDENTALE, INDIRETTO, SPECIALE, CONSEGUENTE O DI QUALSIASI ALTRA NATURA (INCLUSI, SENZA LIMITI, DANNI PER PERDITA DI PROFITTI, INTERRUZIONE DELLE ATTIVITÀ, PERDITA DI INFORMAZIONI D’AFFARI O QUALSIASI ALTRA PERDITA PECUNIARIA) DERIVANTI DALL’USO O DALL’IMPOSSIBILITÀ DI USARE IL PRODOTTO O IN QUALSIASI RELAZIONE AL PRODOTTO, SIA SU BASE DI CONTRATTO, TORTO, NEGLIGENZA, STRETTA RESPONSABILITÀ O ALTRIMENTI, ANCHE SE EIZO O I DISTRIBUTORI EIZO AUTORIZZATI SONO STATI AVVERTITI DELLA POSSIBILITÀ DI TALI DANNI. QUESTA ESCLUSIONE INCLUDE ANCHE QUALSIASI RESPONSABILITÀ CHE POSSA INSORGERE DA RECLAMI DI TERZI CONTRO L’ACQUIRENTE ORIGINALE. L’ESSENZA DI QUESTO PROVVEDIMENTO È LIMITARE LA RESPONSABILITÀ POTENZIALE DI EIZO E DEI DISTRIBUTORI DERIVANTE DA QUESTA GARANZIA LIMITATA E/O DALLE VENDITE.

## BEGRÄNSAD GARANTI

EIZO Corporation (nedan kallat "**EIZO**") och EIZOs auktoriserade distributörer (nedan kallade "**Distributörer**") garanterar i enlighet med villkoren i denna begränsade garanti (nedan kallad "**Garantin**") den ursprunglige köparen (nedan kallad den "**Ursprunglige köparen**") som köpte den i dokumentet specificerade produkten (nedan kallad "**Produkten**") från EIZO eller Distributörer, att EIZO eller Distributörer enligt eget gottfinnande kostnadsfritt antingen reparera eller byta ut den defekta Produkten om den Ursprunglige köparen inom Garantiperioden (definieras nedan) upptäcker att (i) Produkten fungerar felaktigt eller skadas under normal användning av Produkten i enlighet med beskrivningen i bruksanvisningen (nedan kallad "**Bruksanvisning**") eller att (ii) Produktens LCD-panel och ljusstyrka inte kan bibehålla den rekommenderade ljusstyrkan som anges i Bruksanvisningen under normal användning av Produkten i enlighet med beskrivningen i Bruksanvisningen.

Giltighetsperioden för denna garanti är fem (5) år från produktens inköpsdatum (kallas härefter "Garantiperioden"), förutsatt att ljusstyrkan på produkten är garanterad endast om produkten har använts inom den rekommenderade ljusstyrka som beskrivs i Användarmanualen och Garantiperioden för ljusstyrkan är begränsad till fem (5) år från produktens inköpsdatum såvida användningstiden är mindre än eller lika med 20 000 timmar (ljusstyrkan är 400cd/m<sup>2</sup> och färgtemperaturen är 7 500K) eller mindre än eller lika med 30 000 timmar (ljusstyrkan är 300cd/m<sup>2</sup> och färgtemperaturen är 7 500K). EIZO och Distributörer ska inte under några villkor ha något annat ansvar än vad som anges i denna garanti gällande Produkten i relation till den Ursprunglige köparen eller tredje part.

EIZO och Distributörer kommer att upphöra med lagerhållning av Produktens delar efter sju (7) år efter att produktionen av dessa delar upphört. Nät skärmen repareras använder EIZO och distributörer reservdelar som uppfyller våra kvalitetsstandarder.

Garantin är endast giltig i de länder där det finns Distributörer. Garantin begränsar inte några av den Ursprunglige köparens lagstadgade rättigheter.

Oavsett andra villkor i denna garanti ska inte EIZO Distributörer under några villkor ha något ansvar i något av de fall som beskrivs nedan:

- (a) När någon bristfällighet hos Produkten kan härledas till att ha uppstått vid frakt, modifiering, ändring, felaktigt handhavande, olycka, felaktig installation, katastrof, felaktigt underhåll och/eller felaktig reparation utförd av tredje part annan än EIZO och Distributörer.
- (b) Alla former av inkompatibilitet hos Produkten på grund av möjliga tekniska innovationer och/eller bestämmelser.
- (c) Alla försämringar av sensorn;
- (d) Alla försämringar av bildens prestanda beroende på förbrukningsdelar så som LCD-panel och/eller bakgrundsbelysning etc. (t.ex. förändringar i färg, färgjämnhet, defekta pixlar inklusive brända pixlar etc.).
- (e) Alla försämringar av Produkten orsakat av användning av en högre ljusstyrka än den i Bruksanvisningen rekommenderade ljusstyrkan.
- (f) Alla defekter hos Produkten som orsakats av extern utrustning.
- (g) Alla defekter hos Produkten på vilken det ursprungliga serienumret har ändrats eller avlägsnats.
- (h) All normal försämring av Produkten, speciellt förbrukningsartiklar, tillbehör och/eller yttre delar (t.ex. knappar, roterande delar, kablar, Bruksanvisningen etc.).
- (i) Varje deformation, missfärgning och/eller skevhet av Produktens yttre inklusive ytan på LCD-panelen.

För att erhålla service under denna garanti måste den Ursprunglige köparen (med hänseende till risken för skada och/eller förlust under transport) leverera Produkten till närmaste Distributör med förebetald frakt, i dess ursprungliga förpackning eller annan fullgod förpackning som ger likvärdigt skydd. Den Ursprunglige köparen måste kunna visa inköpsbevis för Produkten som klagör Produktens inköpsdatum vid begäran av garantiservice.

Garantiperioden för alla utbytta och/eller reparerade produkter under denna garanti skall upphöra vid utgången av den ursprungliga Garantiperioden.

EIZO ELLER DISTRIBUTÖRER ÄR INTE ANSVARIGA FÖR NÅGON FORM AV SKADA ELLER FÖRLUST AV DATA ELLER ANNAN INFORMATION SOM HAR LAGRATS I NÅGON FORM AV MEDIA ELLER ANNAN DEL AV NÅGON PRODUKT SOM HAR RETURNERATS TILL EIZO ELLER DISTRIBUTÖRER FÖR REPARATION.

EIZO OCH DISTRIBUTÖRERNA GARANTERAR INGET, UTTRYCKLIGEN ELLER UNDERFÖRSTÅTT, VAD BETRÄFFAR PRODUKTEN OCH DESS KVALITET, PRESTANDA, SÄLJBARHET ELLER LÄMPLIGHET FÖR NÅGON FORM AV SPECIELL ANVÄNDNING. UNDER INGA OMSTÄNDIGHETER SKALL EIZO ELLER DISTRIBUTÖRERNA HÅLLAS ANSVARIGA FÖR NÅGRA SOM HELST UNDERORDNADE, INDIREKTA, SPECIELLA, DÄRAV FÖLJANDE ELLER ÖVRIGA SKADOR (INKLUSIVE, UTAN BEGRÄNSNING TILL, SKADOR FÖR FÖRLUST AV INKOMST, AVBRUTEN AFFÄRSRÖRELSE, FÖRLUST AV AFFÄRSINFORMATION ELLER ANNAN SÄRSKILD FÖRLUST) SOM UPPSTÅTT SOM ETT RESULTAT AV ANVÄNDNING ELLER OFÖRMÅGA ATT ANVÄNDA PRODUKTEN ELLER I NÅGON FORM AV ANSLUTNING TILL PRODUKTERNA, VARE SIG DETTA GRUNDAS PÅ KONTRAKT, ÅTALBAR HANDLING, FÖRSUMLIGHET, ANSVARSSKYLDIGHET ELLER ANNAT, ÄVEN OM EIZO ELLER DISTRIBUTÖRERNA HAR INFORMERATS BETRÄFFANDE MÖJLIGHET ATT SÅDANA SKADOR FÖRELIGGER. DETTA UNDANTAG OMFATTAR ÄVEN ALL FORM AV ANSVARSSKYLDIGHET SOM KAN UPPSTÅ GENOM EN TREDJE PARTS ANSPRÅK GENTEMOT DEN URSPRUNGLIGE KÖPAREN. GRUNDBESTÄNDSDELEN I BESTÄMMELSEN ÄR ATT BEGRÄNSA DET EVENTUELLA ANSVARSTAGANDET FÖR EIZO OCH DISTRIBUTÖRERNA SOM KAN UPPSTÅ GENOM DENNA BEGRÄNSADE GARANTI OCH/ELLER FÖRSÄLJNING.



## ОГРАНИЧЕННАЯ ГАРАНТИЯ

EIZO Corporation (называемая в дальнейшем “EIZO”) и авторизованные EIZO дистрибуторы (называемые в дальнейшем “Дистрибуторы”) гарантируют, в соответствии с условиями и пунктами этой ограниченной гарантии (называемой в дальнейшем “Гарантия”), первичному покупателю (называемому в дальнейшем “Первоначальный покупатель”), который приобрел у EIZO или Дистрибуторов продукт, указанный в этом документе (называемый в дальнейшем “Продукт”), что EIZO или Дистрибуторы на свое усмотрение либо бесплатно отремонтируют, либо бесплатно заменят Продукт, если Первоначальный покупатель признает в пределах Гарантийного срока (определенного ниже), что (i) Продукт неисправен или он поврежден в процессе нормального использования Продукта в соответствии с описанием в инструкции по эксплуатации, прилагаемой к Продукту (называемой в дальнейшем “Руководство пользователя”), или что (ii) панель ЖКД и Яркость Продукта не в состоянии поддерживать рекомендованную яркость, указанную в Руководстве пользователя при условии нормального использования Продукта в соответствии с описанием в Руководстве пользователя.

Гарантийный период (называемый в дальнейшем «Гарантийный период») ограничен сроком пять (5) лет со дня приобретения Продукта. Яркость Продукта может быть гарантирована только в том случае, если Продукт использовался с рекомендованной яркостью, указанной в Руководстве пользователя; Гарантийный период в отношении яркости ограничен периодом пять (5) лет со дня приобретения Продукта при условии, что время его использования не превышает 20 000 часов (для яркости 400 Кд/м<sup>2</sup> и цветовой температуры 7500 К) или 30 000 часов (для яркости 300 Кд/м<sup>2</sup> и цветовой температуры 7500 К). EIZO и Дистрибуторы не несут никакой ответственности и не берут обязательств относительно Продукта по отношению к Первоначальному покупателю или по отношению к любым третьим сторонам, кроме обязательств, оговоренных в этой Гарантии.

EIZO и Дистрибуторы прекратят хранение или складирование любых деталей Продукта по истечении семи (7) лет после прекращения производства таких деталей. В случае ремонта монитора EIZO и Дистрибуторы будут использовать запчасти, которые соответствуют нашим стандартам QC (контроль качества).

Гарантия действительна только в странах или регионах, где расположены Дистрибуторы. Гарантия не ограничивает никакие законные права Первоначального покупателя.

Несмотря на другие условия этой Гарантии EIZO и Дистрибуторы не несут никаких обязательств согласно этой Гарантии в любом из перечисленных ниже случаев:

- (а) Любые дефекты Продукта, вызванные повреждениями при перевозке, модификацией, изменением, неправильным обращением, неправильным использованием, авариями, неправильной установкой, стихийными бедствиями, неправильным уходом и/или неправильным ремонтом третьей стороной, отличной от EIZO или Дистрибуторов;
- (б) Любые несовместимости Продукта из-за технических усовершенствований и/или изменения технических норм;
- (в) Любое повреждение датчика;
- (г) Любое ухудшение качества изображения, вызванное устареванием изнашивающихся частей, таких как ЖК-панель и/или задняя подставка и т. д. (например, изменения цветопередачи, цветовой однородности, дефекты пикселей, включая сгоревшие пиксели, и т. д.);
- (д) Любые ухудшения Продукта, вызванные использованием при яркости, повышенной по сравнению с рекомендованной яркостью, описанной в Руководстве пользователя;
- (е) Любые дефекты Продукта, вызванные внешним оборудованием;
- (ж) Любые дефекты Продукта, при которых оригинальный серийный номер был изменен или удален;
- (з) Любые естественные ухудшения продукта, в частности, вызванные износом расходных частей, принадлежностей и/или приспособлений (например, кнопок, вращающихся частей, кабелей, Руководства пользователя и т.д.); и
- (и) Любые деформации, изменения цвета и/или коробления внешней поверхности продукта, включая поверхность панели ЖКД.

Чтобы получить техническое обслуживание в рамках Гарантии, Первоначальный покупатель должен доставить Продукт местному Дистрибутору, оплатив перевозку, в его оригинальной упаковке или в другой соответствующей упаковке, обеспечивающей равноценную степень защиты, принимая во внимание риск повреждения и/или утерю при транспортировке. При запросе технического обслуживания в рамках Гарантии Первоначальный покупатель должен предоставить свидетельство покупки продукта и даты покупки.

Гарантийный период для любого замененного и/или отремонтированного продукта в рамках Гарантии истекает в конце завершения срока действия оригинального Гарантийного периода.

**EIZO ИЛИ ДИСТРИБУТОРЫ НЕ НЕСУТ ОТВЕТСТВЕННОСТИ ЗА ЛЮБЫЕ ПОВРЕЖДЕНИЯ ИЛИ УТЕРЮ ДАННЫХ ИЛИ ДРУГОЙ ИНФОРМАЦИИ, ХРАНЯЩИХСЯ НА КАКИХ-ЛИБО НОСИТЕЛЯХ ИНФОРМАЦИИ ИЛИ НА ЛЮБЫХ ДРУГИХ ЧАСТЯХ ПРОДУКТА, КОТОРЫЙ ВОЗВРАЩЕН EIZO ИЛИ ДИСТРИБУТОРАМ ДЛЯ РЕМОНТА.**

EIZO и ДИСТРИБУТОРЫ НЕ ДАЮТ НИКАКОЙ ДАЛЬНЕЙШЕЙ ГАРАНТИИ, ВЫРАЖЕННОЙ ИЛИ ПОДРАЗУМЕВАЕМОЙ, ОТНОСИТЕЛЬНО ПРОДУКТА И ЕГО КАЧЕСТВА, ТЕХНИЧЕСКИХ ХАРАКТЕРИСТИК, ТОВАРНОСТИ ИЛИ СООТВЕТСТВИЯ ДЛЯ КАКОГО-ЛИБО ОПРЕДЕЛЕННОГО ИСПОЛЬЗОВАНИЯ. НИ ПРИ КАКИХ УСЛОВИЯХ EIZO ИЛИ ДИСТРИБУТОРЫ НЕ НЕСУТ ОТВЕТСТВЕННОСТИ ЗА ЛЮБОЙ СЛУЧАЙНЫЙ, КОСВЕННЫЙ, СПЕЦИАЛЬНЫЙ, ПОБОЧНЫЙ ИЛИ ИНОЙ УЩЕРБ (ВКЛЮЧАЯ, БЕЗ ОГРАНИЧЕНИЙ, УЩЕРБ ИЗ-ЗА НЕПОЛУЧЕННОЙ ПРИБЫЛИ, ПРЕРЫВАНИЯ БИЗНЕСА, ПОТЕРИ КОММЕРЧЕСКОЙ ИНФОРМАЦИИ ИЛИ ЛЮБЫЕ ДРУГИЕ ФИНАНСОВЫЕ ПОТЕРИ), ВОЗНИКШИЙ ИЗ-ЗА ИСПОЛЬЗОВАНИЯ ИЛИ НЕВОЗМОЖНОСТИ ИСПОЛЬЗОВАТЬ ПРОДУКТ ИЛИ В ЛЮБОЙ ДРУГОЙ СВЯЗИ С ПРОДУКТОМ, ЛИБО ОСНОВАННЫЙ НА КОНТРАКТНЫХ ОТНОШЕНИЯХ, ГРАЖДАНСКИХ ПРАВОНАРУШЕНИЯХ, НЕБРЕЖНОСТИ, ПРИЧИНИЕНИЯ УЩЕРБА ТРЕТЬЕЙ СТОРОНЕ ИЛИ ЧЕМ-ЛИБО ЕЩЕ, ДАЖЕ ЕСЛИ EIZO ИЛИ ДИСТРИБУТОРЫ БЫЛИ УВЕДОМЛЕНЫ О ВОЗМОЖНОСТИ ТАКОГО УЩЕРБА. ЭТО ИСКЛЮЧЕНИЕ ТАКЖЕ ВКЛЮЧАЕТ ЛЮБЫЕ ОБЯЗАТЕЛЬСТВА, КОТОРЫЕ МОГУТ ВОЗНИКНУТЬ В РЕЗУЛЬТАТЕ ТРЕБОВАНИЙ ТРЕТЬЕЙ СТОРОНЫ В ОТНОШЕНИИ ПЕРВОНАЧАЛЬНОГО ПОКУПАТЕЛЯ. СУЩЕСТВОМ ЭТОГО ПОЛОЖЕНИЯ ЯВЛЯЕТСЯ ОГРАНИЧЕНИЕ ПОТЕНЦИАЛЬНОЙ ОТВЕТСТВЕННОСТИ EIZO И ДИСТРИБУТОРОВ, ВОЗНИКАЮЩЕЙ ИЗ-ЗА ЭТОЙ ОГРАНИЧЕННОЙ ГАРАНТИИ И/ИЛИ ПРОДАЖ.

## 有限责任保证书

EIZO Corporation (以下简称“EIZO”)和 EIZO 授权的经销商 (以下简称“经销商”), 接受并依照本有限责任保证书 (以下简称“保证书”)之条款, 向从 EIZO 和经销商购买本文中所规定产品 (以下简称“产品”)的原买方 (以下称“原买方”)提供保证:在保证期内 (规定如下), 如果原买方发现 (i) 按本产品所附使用说明书 (以下简称“用户手册”)所述方式正常使用本产品过程中, 本产品出现故障或损坏 或 (ii) 按用户手册所述方式正常使用本产品过程中, 本产品的液晶显示屏 (LCD) 及亮度未能达到用户手册中所述的推荐亮度时, EIZO 和经销商根据其独立的判断免费修理或更换该产品。

本保证期限定为仅按照用户手册所描述的推荐亮度使用本产品时保证其亮度的条件下自购买本产品之日起的五 (5) 年 (以下简称“保证期限”), 亮度的保证期限定为本产品的使用时间在 20000 小时以下 (含 20000 小时) (亮度为 400cd/m<sup>2</sup>, 色温为开氏温度 7500) 或 30000 小时以下 (含 30000 小时) (亮度为 300cd/m<sup>2</sup>, 色温为开氏温度 7500) 的条件下自购买本产品之日起五 (5) 年。EIZO 和经销商将不向原买方或任何第三方承担本保证书所规定之外的与本产品有关任何责任或义务。

本产品的任何部件停产七 (7) 年后, EIZO 和经销商将不再保留或保管任何这类部件。维修显示器时, EIZO 与经销商将使用符合我方质量控制标准的替换零件。

本保证书仅对于设有经销商的国家或地区有效。本保证书并不限定原买方的任何法律权利。

无论本保证书的任何其他条款如何规定, 对于任何下列情况之一, EIZO 和经销商将不承担本保证书规定责任:

- (a) 由于运输损害、改装、改动、滥用、误用、意外事故、错误安装、灾害、维护不善和 / 或由除 EIZO 和经销商以外的第三方进行不适当的修理造成本产品的任何故障。
- (b) 由于可能发生的技术变更和 / 或调整造成本产品的任何不兼容性。
- (c) 传感器的任何劣化;
- (d) 由于诸如液晶显示屏 (LCD) 和 / 或背景照明等消耗品部件的老化造成的任何显示性能低劣 (如色彩变化、色彩均一性变化、包括烧伤像素在内的像素缺陷等)。
- (e) 由于在比用户手册所推荐亮度更高的亮度下使用对本产品所造成的任何老化。
- (f) 因外部设备造成本产品的任何故障。
- (g) 因本产品的原序号被改变或消除造成本产品的任何故障。
- (h) 本产品的任何正常老化, 尤其是消耗品、附件和 / 或附加装置 (如按钮、旋转部件、电缆、用户手册等)、以及
- (i) 本产品表面包括液晶显示屏 (LCD) 表面的任何变形、变色和 / 翘曲。

为了获得本保证书规定的服务, 原买方必须使用原包装或其他具有同等保护程度的适当包装将本产品运送到当地的经销商, 并且预付运费, 承担运输中的损坏和 / 或损失的风险。要求提供本保证书规定的服务时, 原买方必须提交购买本产品和标明此购买日期的证明。

按本保证书规定进行了更换和 / 或修理的任何产品的保证期限, 将在原保证期限结束时终止。

在返回给 EIZO 和经销商进行修理后, 任何产品的任何媒体或任何部件中储存的数据或其他信息发生任何损坏或损失, 对此 EIZO 和经销商将不承担责任。

对于本产品及其质量、性能、可销售性以及对于特殊用途的适合性, EIZO 和经销商不提供其他任何明示或暗示的保证。因使用本产品或无法使用本产品或因与本产品有任何关系 (无论是否根据合同) 而造成: 任何附带的、间接的、特殊的、随之发生的或其他的损害 (包括但不限于: 利润损失、业务中断、业务信息丢失或其他任何金钱损失) 以及侵权行为、过失、严格赔偿责任或其他责任, 即使已经向 EIZO 和经销商提出了发生这些损害的可能性, 对此 EIZO 和经销商概不承担责任。本免责条款还包括因第三方向原买方提出索赔而可能发生的任何责任。本条款的本质是限定由于本有限责任保证书和 / 或销售本产品所发生的 EIZO 和经销商的潜在责任。

# LIMITED WARRANTY (RX850)

## LIMITED WARRANTY

EIZO Corporation (hereinafter referred to as “EIZO”) and distributors authorized by EIZO (hereinafter referred to as the “Distributors”) warrant, subject to and in accordance with the terms of this limited warranty (hereinafter referred to as the “Warranty”), to the original purchaser (hereinafter referred to as the “Original Purchaser”) who purchased the product specified in this document (hereinafter referred to as the “Product”) from EIZO or Distributors, that EIZO and Distributors shall, at their sole discretion, either repair or replace the Product at no charge if the Original Purchaser becomes aware within the Warranty Period (defined below) that (i) the Product malfunctions or is damaged in the course of normal use of the Product in accordance with the description in the instruction manual attached to the Product (hereinafter referred to as the “User’s Manual”), or (ii) the LCD panel and brightness of the Product cannot maintain the recommended brightness specified in the User’s Manual in the course of normal use of the Product in accordance with the description of the User’s Manual.

The period of this Warranty is five (5) years from the date of purchase of the Product (hereinafter referred to as the “Warranty Period”), provided that the brightness of the Product shall be warranted only if the Product has been used within the recommended brightness described in the User’s Manual and the Warranty Period for the brightness is limited to five (5) years from the date of purchase of the Product subject to the usage time being less than or equal to 20,000 hours (the brightness is 500cd/m<sup>2</sup> and color temperature is 7500K) or less than or equal to 30,000 hours (the brightness is 400cd/m<sup>2</sup> and color temperature is 7500K). EIZO and Distributors shall bear no liability or obligation with regard to the Product in relation to the Original Purchaser or any third parties other than as provided under this Warranty.

EIZO and Distributors will cease to hold or store any parts of the Product upon expiration of seven (7) years after the production of such parts is discontinued. In repairing the monitor, EIZO and Distributors will use renewal parts which comply with our QC standards.

The Warranty is valid only in the countries or territories where the Distributors are located. The Warranty does not restrict any legal rights of the Original Purchaser.

Notwithstanding any other provision of this Warranty, EIZO and Distributors shall have no obligation under this Warranty whatsoever in any of the cases as set forth below:

- (a) Any defect of the Product caused by freight damage, modification, alteration, abuse, misuse, accident, incorrect installation, disaster, faulty maintenance and/or improper repair by third party other than EIZO and Distributors;
- (b) Any incompatibility of the Product due to possible technical innovations and/or regulations;
- (c) Any deterioration of the sensor;
- (d) Any deterioration of display performance caused by the deterioration of expendable parts such as the LCD panel and/or backlight, etc. (e.g. changes in brightness uniformity, changes in color, changes in color uniformity, defects in pixels including burnt pixels, etc.);
- (e) Any deterioration of the Product caused by the use at higher brightness than the recommended brightness described in the User’s Manual;
- (f) Any defect of the Product caused by external equipment;
- (g) Any defect of the Product on which the original serial number has been altered or removed;
- (h) Any normal deterioration of the product, particularly that of consumables, accessories, and/or attachments (e.g. buttons, rotating parts, cables, User’s Manual, etc.); and
- (i) Any deformation, discoloration, and/or warp of the exterior of the product including that of the surface of the LCD panel.

To obtain service under the Warranty, the Original Purchaser must deliver the Product, freight prepaid, in its original package or other adequate package affording an equal degree of protection, assuming the risk of damage and/or loss in transit, to the local Distributor. The Original Purchaser must present proof of purchase of the Product and the date of such purchase when requesting services under the Warranty.

The Warranty Period for any replaced and/or repaired product under this Warranty shall expire at the end of the original Warranty Period.

EIZO OR DISTRIBUTORS ARE NOT RESPONSIBLE FOR ANY DAMAGE TO, OR LOSS OF, DATA OR OTHER INFORMATION STORED IN ANY MEDIA OR ANY PART OF ANY PRODUCT RETURNED TO EIZO OR DISTRIBUTORS FOR REPAIR.

EIZO AND DISTRIBUTORS MAKE NO FURTHER WARRANTIES, EXPRESSED OR IMPLIED, WITH RESPECT TO THE PRODUCT AND ITS QUALITY, PERFORMANCE, MERCHANTABILITY OR FITNESS FOR ANY PARTICULAR USE. IN NO EVENT SHALL EIZO OR DISTRIBUTORS BE LIABLE FOR ANY INCIDENTAL, INDIRECT, SPECIAL, CONSEQUENTIAL OR OTHER DAMAGE WHATSOEVER (INCLUDING, WITHOUT LIMITATION, DAMAGES FOR LOSS OF PROFIT, BUSINESS INTERRUPTION, LOSS OF BUSINESS INFORMATION, OR ANY OTHER PECUNIARY LOSS) ARISING OUT OF THE USE OR INABILITY TO USE THE PRODUCT OR IN ANY CONNECTION WITH THE PRODUCT, WHETHER BASED ON CONTRACT, TORT, NEGLIGENCE, STRICT LIABILITY OR OTHERWISE, EVEN IF EIZO OR DISTRIBUTORS HAVE BEEN ADVISED OF THE POSSIBILITY OF SUCH DAMAGES. THIS EXCLUSION ALSO INCLUDES ANY LIABILITY WHICH MAY ARISE OUT OF THIRD PARTY CLAIMS AGAINST THE ORIGINAL PURCHASER. THE ESSENCE OF THIS PROVISION IS TO LIMIT THE POTENTIAL LIABILITY OF EIZO AND DISTRIBUTORS ARISING OUT OF THIS LIMITED WARRANTY AND/OR SALES.

## BEGRENZTE GARANTIE

EIZO Corporation (im Weiteren als „**EIZO**“ bezeichnet) und die Vertragsimporteure von EIZO (im Weiteren als „**Vertrieb(e)**“ bezeichnet) garantieren dem ursprünglichen Käufer (im Weiteren als „**Erstkäufer**“ bezeichnet), der das in diesem Dokument vorgegebene Produkt (im Weiteren als „**Produkt**“ bezeichnet) von EIZO oder einem Vertrieb erworben hat, gemäß den Bedingungen dieser beschränkten Garantie (im Weiteren als „**Garantie**“ bezeichnet), dass EIZO und der Vertrieb nach eigenem Ermessen das Produkt entweder kostenlos reparieren oder austauschen, falls der Erstkäufer innerhalb der Garantiefrist (weiter unten festgelegt) entweder (i) eine Fehlfunktion bzw. Beschädigung des Produkts feststellt, die während des normalen Gebrauchs des Produkts gemäß den Anweisungen des zum Lieferumfang des Produkts gehörenden Benutzerhandbuchs (im Weiteren als „**Benutzerhandbuch**“ bezeichnet) aufgetreten ist, oder (ii) das LCD-Panel und die Helligkeit des Produkts während des normalen Gebrauchs des Produkts gemäß den Anweisungen des Benutzerhandbuchs nicht die im Benutzerhandbuch genannte empfohlene Helligkeit aufrecht erhalten können.

Die Dauer der Garantieleistung beträgt fünf (5) Jahre ab dem Kaufdatum des Produkts (im Weiteren als „**Garantiefrist**“ bezeichnet), wobei vorausgesetzt wird, dass die Helligkeit des Produkts nur garantiert wird, wenn das Produkt innerhalb der empfohlenen Helligkeit, wie im Benutzerhandbuch beschrieben, verwendet wird, und die Dauer der Garantiefrist für die Helligkeit beträgt fünf (5) Jahre ab dem Kaufdatum des Produkts, wobei die Nutzungszeit des Produkts auf maximal 20.000 Betriebsstunden (bei einer Helligkeit von 500 cd/m<sup>2</sup> und einer Farbtemperatur von 7500 K) oder maximal 30.000 Betriebsstunden (bei einer Helligkeit von 400 cd/m<sup>2</sup> und einer Farbtemperatur von 7500 K) beschränkt ist. EIZO und die Vertriebe übernehmen über den Rahmen dieser Garantie hinaus hinsichtlich des Produkts keinerlei Haftung oder Verpflichtung dem Erstkäufer oder Dritten gegenüber.

EIZO und die Vertriebe verpflichten sich, Ersatzteile für das Produkt über einen Zeitraum von sieben (7) Jahren nach Einstellung der Produktion der Ersatzteile zu lagern bzw. anzubieten. EIZO und seine Vertriebspartner verpflichten sich, bei einer etwaigen Reparatur des Monitors ausschließlich Produkte gemäß den EIZO-Qualitätssicherungsstandards zu verwenden.

Diese Garantie gilt nur in Ländern oder Gebieten, in denen sich Vertriebe befinden. Die gesetzlichen Gewährleistungsrechte des Erstkäufers gegenüber dem Verkäufer werden durch diese Garantie nicht berührt.

EIZO und die Vertriebe besitzen im Rahmen dieser Garantie keinerlei Verpflichtung in den folgenden Fällen:

- (a) Produktdefekte, die auf Frachtschäden, Modifikation, Nachgestaltung, Missbrauch, Fehlbedienung, Unfälle, unsachgemäße Installation, Naturkatastrophen, fehlerhafte Wartung und/oder unsachgemäße Reparatur durch eine andere Partei als EIZO und die Vertriebe zurückzuführen sind.
- (b) Eine Inkompatibilität des Produkts aufgrund von technischen Neuerungen und/oder neuen Bestimmungen, die nach dem Kauf in Kraft treten.
- (c) Jegliche Verschlechterung des Sensors;
- (d) Jegliche Verschlechterung der Bildschirmleistung, die durch Verschleißteile wie den LCD-Panel und/oder die Hintergrundbeleuchtung usw. hervorgerufen werden (z.B. Veränderungen von Helligkeitsverteilung, Farben oder Farbverteilung, Pixeldefekte einschließlich ausgebrannter Pixel usw.).
- (e) Jegliche Abnutzung des Produkts, die auf einen Gebrauch mit einer höheren Helligkeit als die im Benutzerhandbuch genannte empfohlene Helligkeit zurückzuführen ist.
- (f) Produktdefekte, die durch externe Geräte verursacht werden.
- (g) Jeglicher Defekt eines Produkts, dessen ursprüngliche Seriennummer geändert oder entfernt wurde.
- (h) Normale Abnutzung des Produkts, insbesondere von Verbrauchsteilen, Zubehörteilen und/oder Beilagen (z.B. Tasten, drehbare Teile, Kabel, Benutzerhandbuch usw.); sowie
- (i) Verformungen, Verfärbungen und/oder Verziehungen am Produktäußeren, einschließlich der Oberfläche des LCD-Panels.

Bei Inanspruchnahme der Garantieleistung ist der Erstkäufer verpflichtet, das Produkt auf eigene Kosten und in der Originalverpackung bzw. einer anderen geeigneten Verpackung, die einen gleichwertigen Schutz gegen Transportschäden bietet, an den örtlichen Vertrieb zu übersenden, wobei der Erstkäufer das Transportrisiko gegenüber Schäden und/oder Verlust trägt. Zum Zeitpunkt der Inanspruchnahme der Garantieleistung muss der Erstkäufer einen Verkaufsbeleg vorweisen, auf dem das Kaufdatum angegeben ist.

Die Garantiefrist für ein im Rahmen dieser Garantie ausgetauschtes und/oder repariertes Produkt erlischt nach Ablauf der ursprünglichen Garantiefrist.

EIZO ODER DIE EIZO-VERTRAGSIMPORTEURE HAFTEN NICHT FÜR ZERSTÖRTE DATENBESTÄNDE ODER DIE KOSTEN DER WIEDERBESCHAFFUNG DIESER DATENBESTÄNDE AUF JEDLICHEN DATENTRÄGERN ODER TEILEN DES PRODUKTS, DIE IM RAHMEN DER GARANTIE BEI EIZO ODER DEN EIZO-VERTRAGSIMPORTEUREN ZUR REPARATUR EINGEREICHT WURDEN.

EIZO UND DIE EIZO-VERTRAGSIMPORTEURE GEBEN WEDER EXPLIZITE NOCH IMPLIZITE GARANTIEEN IN BEZUG AUF DIESES PRODUKT UND SEINE QUALITÄT, LEISTUNG, VERKÄUFLICHKEIT ODER EIGNUNG FÜR EINEN BESTIMMTEN ZWECK. AUF KEINEN FALL SIND EIZO ODER DIE EIZO-VERTRAGSIMPORTEURE VERANTWORTLICH FÜR JEDLICHE ZUFÄLLIGE, INDIREKTE, SPEZIELLE, FOLGE- ODER ANDERE SCHÄDEN JEDLICHER ART (EINSCHLIESSLICH OHNE JEDE BEGRENZUNG SCHÄDEN BEZÜGLICH PROFITVERLUST, GESCHÄFTSUNTERBRECHUNG, VERLUST VON GESCHÄFTSINFORMATION ODER JEDLICHE ANDEREN FINANZIELLEN EINBUSSEN), DIE DURCH DIE VERWENDUNG DES PRODUKTES ODER DIE UNFÄHIGKEIT ZUR VERWENDUNG DES PRODUKTES ODER IN JEDLICHER BEZIEHUNG MIT DEM PRODUKT, SEI ES BASIEREND AUF VERTRAG, SCHADENSERSATZ, NACHLAESSIGKEIT, STRIKTE HAFTPFLICHT ODER ANDEREN FORDERUNGEN ENTSTEHEN, AUCH WENN EIZO UND DIE EIZO-VERTRAGSIMPORTEURE IM VORAUS ÜBER DIE MÖGLICHKEIT SOLCHER SCHÄDEN INFORMIERT WURDEN. DIESER AUSSCHLUSS ENTHÄLT AUCH JEDE HAFTPFLICHT, DIE AUS FORDERUNGEN DRITTER GEGEN DEN ERSTKÄUFER ENTSTEHEN KANN. ZWECK DIESER KLAUSEL IST ES, DIE HAFTUNG VON EIZO UND DEN VERTRIEBEN GEGENÜBER FORDERUNGEN ZU BEGRENZEN, DIE AUS DIESER BESCHRÄNKTEN GARANTIE UND/ODER DEM VERKAUF ENTSTEHEN KÖNNEN.



## GARANTIE LIMITÉE

EIZO Corporation (ci-après dénommé « **EIZO** ») et les distributeurs autorisés par EIZO (ci-après dénommés « **Distributeurs** »), sous réserve et conformément aux termes de cette garantie limitée (ci-après dénommée « **Garantie** »), garantissent à l'acheteur initial (ci-après dénommé « **Acheteur initial** ») du produit spécifié dans la présente (ci-après dénommé « **Produit** ») acheté auprès d'EIZO ou de Distributeurs agréés EIZO, que EIZO et ses Distributeurs auront pour option de réparer ou remplacer gratuitement le Produit si l'Acheteur initial constate, pendant la Période de garantie (définie ci-dessous), (i) qu'il y a un dysfonctionnement ou que le Produit a subi un dommage dans le cadre d'une utilisation normale du Produit conformément à la description du mode d'emploi qui accompagne le Produit (ci-après dénommé « **Manuel d'utilisateur** »), ou (ii) que le panneau LCD et la luminosité du Produit ne peuvent pas maintenir la luminosité recommandée spécifiée dans le Manuel d'utilisation dans le cadre d'une utilisation normale du Produit, conformément à la description du Manuel d'utilisation.

La période de cette Garantie est limitée à cinq (5) ans à partir de la date d'achat du Produit (ci-après dénommée « Période de Garantie »), sous réserve que la luminosité du Produit ne sera garantie que si le Produit a été utilisé conformément à la luminosité recommandée dans le Manuel d'Utilisation et la Période de Garantie en matière de luminosité est limitée à cinq (5) ans à compter de la date d'achat du Produit, sous réserve que la durée d'utilisation soit inférieure ou égale à 20 000 heures (la luminosité est de 500 cd/m<sup>2</sup> et la température de la couleur à 7500 K) ou inférieure ou égale à 30 000 heures (la luminosité est de 400 cd/m<sup>2</sup> et la température de la couleur à 7500 K). EIZO et ses Distributeurs déclinent toute responsabilité ou obligation concernant ce Produit face à l'Acheteur initial ou à toute autre personne à l'exception de celles stipulées dans la présente Garantie.

EIZO et ses Distributeurs cesseront de tenir ou conserver en stock toute pièce de ce Produit après l'expiration de la période de sept (7) ans suivant l'arrêt de la production de telles pièces. Pour réparer le moniteur, EIZO et ses distributeurs utiliseront des pièces de rechange conformes à nos normes de contrôle qualité.

La Garantie est valable uniquement dans les pays ou les territoires où se trouvent les Distributeurs. La Garantie ne limite aucun des droits reconnus par la loi à l'Acheteur initial.

Nonobstant toute autre clause de cette Garantie, EIZO et ses Distributeurs n'auront d'obligation dans le cadre de cette Garantie pour aucun des cas énumérés ci-dessous :

- (a) Tout défaut du Produit résultant de dommages occasionnés lors du transport, d'une modification, d'une altération, d'un abus, d'une mauvaise utilisation, d'un accident, d'une installation incorrecte, d'un désastre, d'un entretien et/ou d'une réparation incorrects effectués par une personne autre que EIZO ou ses Distributeurs ;
- (b) Toute incompatibilité du Produit résultant d'améliorations techniques et/ou réglementations possibles ;
- (c) Toute détérioration du capteur ;
- (d) Toute détérioration des performances d'affichage causée par la détérioration des éléments consommables tels que le panneau LCD et/ou le rétroéclairage, etc. (par exemple, des changements de l'uniformité de la luminosité, des changements de couleur, des changements de l'uniformité des couleurs, des défauts de pixels, y compris des pixels brûlés, etc.) ;
- (e) Toute détérioration du Produit causée par l'utilisation d'une luminosité plus élevée que la luminosité recommandée, telle que décrite dans le Manuel d'utilisation ;
- (f) Tout défaut du Produit causé par un appareil externe ;
- (g) Tout défaut d'un Produit sur lequel le numéro de série original a été altéré ou supprimé ;
- (h) Toute détérioration normale du Produit, particulièrement celle des consommables, des accessoires et/ou des pièces reliées au Produit (touches, éléments pivotants, câbles, Manuel d'utilisation etc.), et
- (i) Toute déformation, décoloration, et/ou gondolage de l'extérieur du Produit, y compris celle de la surface du panneau LCD.

Pour bénéficier d'un service dans le cadre de cette Garantie, l'Acheteur initial doit renvoyer le Produit port payé, dans son emballage d'origine ou tout autre emballage approprié offrant un degré de protection équivalent, au Distributeur local, et assumera la responsabilité des dommages et/ou perte possibles lors du transport. L'Acheteur initial doit présenter une preuve d'achat du Produit comprenant sa date d'achat pour bénéficier de ce service dans le cadre de la Garantie.

La Période de garantie pour tout Produit remplacé et/ou réparé dans le cadre de cette Garantie expirera à la fin de la Période de garantie initiale.

**EIZO OU SES DISTRIBUTEURS NE SAURONT ÊTRE TENUS RESPONSABLES DES DOMMAGES OU PERTES DE DONNÉES OU D'AUTRES INFORMATIONS STOCKÉES DANS UN MÉDIA QUELCONQUE OU UNE AUTRE PARTIE DU PRODUIT RENVOYÉ À EIZO OU AUX DISTRIBUTEURS POUR RÉPARATION.**

AUCUNE AUTRE GARANTIE, EXPLICITE OU TACITE, N'EST OFFERTE PAR EIZO ET SES DISTRIBUTEURS CONCERNANT LE PRODUIT ET SES QUALITÉS, PERFORMANCES, QUALITÉ MARCHANDE OU ADAPTATION À UN USAGE PARTICULIER. EN AUCUN CAS, EIZO OU SES DISTRIBUTEURS NE SERONT RESPONSABLES DES DOMMAGES FORTUITS, INDIRECTS, SPÉCIAUX, INDUITS, OU DE TOUT AUTRE DOMMAGE QUEL QU'IL SOIT (Y COMPRIS, SANS LIMITATION, LES DOMMAGES RÉSULTANT D'UNE PERTE DE PROFIT, D'UNE INTERRUPTION D'ACTIVITÉS, D'UNE PERTE DE DONNÉES COMMERCIALES, OU DE TOUT AUTRE MANQUE À GAGNER) RÉSULTANT DE L'UTILISATION OU DE L'INCAPACITÉ D'UTILISER LE PRODUIT OU AYANT UN RAPPORT QUELCONQUE AVEC LE PRODUIT, QUE CE SOIT SUR LA BASE D'UN CONTRAT, D'UN TORT, D'UNE NÉGLIGENCE, D'UNE RESPONSABILITÉ STRICTE OU AUTRE, MÊME SI EIZO OU SES DISTRIBUTEURS ONT ÉTÉ AVERTIS DE LA POSSIBILITÉ DE TELS DOMMAGES. CETTE LIMITATION INCLUT AUSSI TOUTE RESPONSABILITÉ QUI POURRAIT ÊTRE SOULEVÉE LORS DES RÉCLAMATIONS D'UN TIERS CONTRE L'ACHETEUR INITIAL. L'ESSENCE DE CETTE CLAUSE EST DE LIMITER LA RESPONSABILITÉ POTENTIELLE DE EIZO ET DE SES DISTRIBUTEURS RÉSULTANT DE CETTE GARANTIE LIMITÉE ET/OU DES VENTES.

## GARANTÍA LIMITADA

EIZO Corporation (en lo sucesivo “**EIZO**”) y sus distribuidores autorizados por EIZO (en lo sucesivo los “**Distribuidores**”), con arreglo y de conformidad con los términos de esta garantía limitada (en lo sucesivo la “**Garantía**”), garantizan al comprador original (en lo sucesivo el “**Comprador original**”) que compró el producto especificado en este documento (en lo sucesivo el “**Producto**”) a EIZO o a sus Distribuidores, que EIZO y sus Distribuidores, a su propio criterio, repararán o sustituirán el Producto de forma gratuita si el Comprador original detecta dentro del periodo de la Garantía (indicado posteriormente) que: (i) el Producto no funciona correctamente o que se ha averiado durante el uso normal del mismo de acuerdo con las indicaciones del manual de instrucciones suministrado con el Producto (en lo sucesivo el “**Manual del usuario**”); o (ii) el panel LCD y el brillo del Producto no pueden mantener el brillo recomendado que se especifica en el Manual del usuario durante el uso normal del Producto de acuerdo con las descripciones del Manual del usuario.

El período de validez de esta Garantía es de cinco (5) años a contar desde la fecha de compra del Producto (en adelante, “**Período de garantía**”), teniendo en cuenta que el brillo del Producto sólo estará cubierto por la garantía si el Producto se ha utilizado con el brillo recomendado que se describe en el Manual del usuario, y que el Periodo de garantía está limitado a cinco (5) años a partir de la fecha de compra del Producto, siempre que el tiempo de uso sea inferior o igual a 20.000 horas (siendo el brillo de 500cd/m<sup>2</sup> y la temperatura de color de 7500K) o inferior o igual a 30.000 horas (siendo el brillo de 400cd/m<sup>2</sup> y la temperatura de color de 7500K). EIZO y sus Distribuidores no tendrán ninguna responsabilidad ni obligación con respecto al Producto para con el Comprador original ni con terceros que no sean las estipuladas en la presente Garantía.

EIZO y sus Distribuidores no estarán obligados a suministrar cualquier recambio del Producto una vez pasados siete (7) años desde que se deje de fabricar el mismo. Para la reparación del monitor, EIZO y los distribuidores utilizarán repuestos que cumplan con nuestros estándares de control de calidad.

La Garantía es válida sólo en los países y territorios donde están ubicados los Distribuidores. La Garantía no restringe ningún derecho legal del Comprador original.

A pesar de las estipulaciones de esta Garantía, EIZO y sus Distribuidores no tendrán obligación alguna bajo esta Garantía en ninguno de los casos expuestos a continuación:

- (a) Cualquier defecto del Producto causado por daños en el transporte, modificación, alteración, abuso, uso incorrecto, accidente, instalación incorrecta, desastre, mantenimiento incorrecto y/o reparación indebida realizada por un tercero que no sea EIZO o sus Distribuidores.
- (b) Cualquier incompatibilidad del Producto debida a posibles innovaciones técnicas y/o reglamentaciones.
- (c) Cualquier deterioro del sensor;
- (d) Cualquier deterioro en el rendimiento de la visualización causado por fallos en las piezas consumibles como el panel de cristal líquido y/o la luz de fondo, etc. (p.ej. cambios de uniformidad del brillo, cambios de color, cambios de uniformidad del color, defectos de píxeles, incluyendo píxeles muertos, etc.).
- (e) Cualquier deterioro del Producto causado por el uso continuado con un brillo superior al recomendado en el Manual del usuario.
- (f) Cualquier defecto del Producto causado por un equipo externo.
- (g) Cualquier defecto del Producto en el que haya sido alterado o borrado el número de serie original.
- (h) Cualquier deterioro normal del Producto, y en particular de las piezas consumibles, accesorios y demás (p. ej. botones, piezas giratorias, cables, Manual del usuario, etc.).
- (i) Cualquier deformación, decoloración y/o alabeo del exterior del Producto incluida la superficie del panel LCD.

Para obtener servicio en los términos de esta Garantía, el Producto deberá ser enviado por el Comprador original, a su Distribuidor local, con el transporte previamente pagado, en el embalaje original u otro embalaje adecuado que ofrezca el mismo grado de protección, asumiendo el riesgo de daños y/o pérdida del Producto durante el transporte. El Comprador original deberá presentar un comprobante de compra del Producto en el que se refleje la fecha de compra del mismo cuando lo solicite el servicio de Garantía.

El Periodo de garantía para cualquier Producto reemplazado y/o reparado en los términos de esta Garantía expirará al vencer el Periodo de garantía original.

EIZO O LOS DISTRIBUIDORES AUTORIZADOS DE EIZO NO SE RESPONSABILIZAN DE NINGÚN DAÑO O PÉRDIDA QUE PUEDAN SUFRIR LOS DATOS U OTRA INFORMACIÓN ALMACENADA EN CUALQUIER MEDIO O CUALQUIER PARTE DE CUALQUIER PRODUCTO DEVUELTO A EIZO O A LOS DISTRIBUIDORES DE EIZO PARA SU REPARACIÓN.

EIZO Y LOS DISTRIBUIDORES AUTORIZADOS DE EIZO NO OFRECEN NINGUNA OTRA GARANTÍA, IMPLÍCITA NI EXPLÍCITA, CON RESPECTO AL PRODUCTO Y A SU CALIDAD, RENDIMIENTO, COMERCIALIZACIÓN E IDONEIDAD PARA CUALQUIER USO EN PARTICULAR. EN NINGÚN CASO SERÁN EIZO O LOS DISTRIBUIDORES AUTORIZADOS DE EIZO RESPONSABLES DE NINGÚN DAÑO EMERGENTE, INDIRECTO, ESPECIAL, INHERENTE O CUALQUIERA QUE SEA (INCLUYENDO, SIN LIMITACIÓN, DAÑOS POR LUCRO CESANTE, INTERRUPCIÓN DE LA ACTIVIDAD COMERCIAL, PÉRDIDA DE INFORMACIÓN COMERCIAL O CUALQUIER OTRA PÉRDIDA PECUNIARIA) QUE SE DERIVE DEL USO O IMPOSIBILIDAD DE USO DEL PRODUCTO O EN RELACIÓN CON EL PRODUCTO, YA SEA BASADO EN CONTRATO, POR AGRAVIO, NEGLIGENCIA, ESTRICTA RESPONSABILIDAD O CUALQUIERA QUE SEA, AUN CUANDO SE HAYA ADVERTIDO A EIZO O A LOS DISTRIBUIDORES DE EIZO DE LA POSIBILIDAD DE TALES DAÑOS. ESTA EXCLUSIÓN TAMBIÉN ABARCA CUALQUIER RESPONSABILIDAD QUE PUEDA DERIVARSE DE RECLAMACIONES HECHAS POR UN TERCERO CONTRA EL COMPRADOR ORIGINAL. LA ESENCIA DE ESTA ESTIPULACIÓN ES LIMITAR LA RESPONSABILIDAD POTENCIAL DE EIZO Y LOS DISTRIBUIDORES QUE PUDIERA DERIVARSE DE ESTA GARANTÍA LIMITADA Y/O VENTAS.

## GARANZIA LIMITATA

EIZO Corporation (a cui si farà riferimento da qui in poi con “EIZO”) ed i Distributori autorizzati da EIZO (a cui si farà riferimento da qui in poi con “Distributori”) garantiscono, secondo i termini di questa garanzia limitata (a cui si farà riferimento da qui in poi con “Garanzia”) all’acquirente originale (a cui si farà riferimento da qui in poi con “Acquirente originale”) che ha acquistato il prodotto specificato in questo documento (a cui si farà riferimento da qui in poi con “Prodotto”) da EIZO o dai suoi Distributori, che EIZO e i distributori, a loro discrezione, ripareranno o sostituiranno il Prodotto senza addebito se l’Acquirente originale trova, entro il periodo della Garanzia (definito sotto), che (i) il Prodotto malfunziona e si è danneggiato nel corso del suo normale utilizzo osservando le indicazioni del manuale di istruzioni allegato al Prodotto (a cui si farà riferimento da qui in poi con “Manuale utente”), o che (ii) il pannello LCD e la luminosità del Prodotto non possono mantenere la luminosità raccomandata specificata nel Manuale utente nel corso del normale utilizzo del Prodotto osservando le indicazioni del Manuale utente.

La presente Garanzia ha una validità di cinque (5) anni dalla data dell’acquisto del Prodotto (di qui in avanti “Periodo di Garanzia”), considerando che la luminosità del Prodotto sarà garantita solo se il Prodotto è stato utilizzato con la luminosità consigliata descritta nel Manuale utente e che il Periodo di garanzia per la luminosità è limitato a cinque (5) anni dalla data di acquisto del Prodotto, a condizione che il tempo di utilizzo sia inferiore o uguale a 20.000 ore (luminosità di 500cd/m<sup>2</sup> e temperatura colore di 7.500K) o inferiore o uguale a 30.000 ore (luminosità di 400cd/m<sup>2</sup> e temperatura colore di 7.500K). EIZO e i suoi Distributori non si assumono alcuna responsabilità e non hanno alcun obbligo riguardo al Prodotto verso l’Acquirente originale o terzi diversi da quelli relativi a questa Garanzia.

EIZO e i suoi Distributori cesseranno di tenere o di conservare qualsiasi ricambio del Prodotto allo scadere di sette (7) anni dopo che la produzione di tali ricambi è stata terminata. Per la riparazione del monitor, EIZO e i Distributori utilizzeranno parti di ricambio conformi ai nostri standard di controllo della qualità.

La Garanzia è valida soltanto nei paesi dove ci sono i Distributori EIZO. La Garanzia non limita alcun diritto legale dell’Acquirente originale.

Indipendentemente da qualsiasi altra condizione di questa Garanzia, EIZO e i suoi Distributori non avranno alcun obbligo derivante da questa Garanzia in ognuno dei casi elencati di seguito:

- (a) Qualsiasi difetto del Prodotto causato da danni di trasporto, modifiche, alterazioni, abusi, usi impropri, incidenti, installazione errata, calamità, manutenzione errata e/o riparazioni improprie eseguite da terze parti che non siano EIZO o i suoi Distributori.
- (b) Qualsiasi incompatibilità del Prodotto dovuta a possibili innovazioni tecniche e/o normative.
- (c) Qualsiasi deterioramento del sensore;
- (d) Qualsiasi deterioramento delle prestazioni dello schermo causato dal deterioramento delle parti consumabili, come il pannello LCD e/o la retroilluminazione, ecc. (per esempio: cambiamenti di uniformità della luminosità, cambiamenti di colore, cambiamenti di uniformità del colore, difetti dei pixel, inclusi i pixel bruciati, ecc.).
- (e) Qualsiasi deterioramento del Prodotto causato dal suo utilizzo ad una luminosità più alta di quella raccomandata nel Manuale utente.
- (f) Qualsiasi difetto del Prodotto causato da apparecchiature esterne.
- (g) Qualsiasi difetto del Prodotto in cui il numero di serie originale sia stato alterato o rimosso.
- (h) Qualsiasi normale deterioramento del Prodotto, in particolar modo nelle sue parti di consumo, accessori, e/o attacchi (per esempio: tasti, parti rotanti, cavi, Manuale dell’utente, ecc.).
- (i) Qualsiasi tipo di deformazione, scolorimento, e/o di involucro esterno del Prodotto inclusa la superficie del pannello LCD.

Per ricevere assistenza tecnica con questa Garanzia, l’Acquirente originale deve inviare il Prodotto, con trasporto pre-pagato, nella sua confezione originale o altra confezione adeguata che fornisce un livello analogo di protezione, assumendosi il rischio di danni e/o perdita in transito, al Distributore locale. L’Acquirente originale deve presentare la prova di acquisto che stabilisce la data di acquisto del Prodotto quando richiede servizio sotto Garanzia.

Il Periodo di garanzia per qualsiasi Prodotto sostituito e/o riparato sotto questa Garanzia scade alla fine del Periodo di garanzia originale.

EIZO O I SUOI DISTRIBUTORI NON SONO RESPONSABILI PER QUALSIASI DANNO O PERDITA DI DATI O ALTRE INFORMAZIONI MEMORIZZATI SU QUALSIASI SUPPORTO O QUALSIASI PARTE DI QUALSIASI PRODOTTO INVIATO A EIZO O I SUOI DISTRIBUTORI PER RIPARAZIONI.

EIZO E I SUOI DISTRIBUTORI NON OFFRONO ALCUNA GARANZIA ADDIZIONALE, IMPLICITA O ESPLICITA, RIGUARDO IL PRODOTTO E LA SUA QUALITÀ, PRESTAZIONI, VENDIBILITÀ O APPROPRIATEZZA PER QUALSIASI USO PARTICOLARE. IN NESSUN CASO EIZO O I DISTRIBUTORI EIZO AUTORIZZATI SARANNO RESPONSABILI PER QUALSIASI DANNO ACCIDENTALE, INDIRETTO, SPECIALE, CONSEGUENTE O DI QUALSIASI ALTRA NATURA (INCLUSI, SENZA LIMITI, DANNI PER PERDITA DI PROFITTI, INTERRUZIONE DELLE ATTIVITÀ, PERDITA DI INFORMAZIONI D’AFFARI O QUALSIASI ALTRA PERDITA PECUNIARIA) DERIVANTI DALL’USO O DALL’IMPOSSIBILITÀ DI USARE IL PRODOTTO O IN QUALSIASI RELAZIONE AL PRODOTTO, SIA SU BASE DI CONTRATTO, TORTO, NEGLIGENZA, STRETTA RESPONSABILITÀ O ALTRIMENTI, ANCHE SE EIZO O I DISTRIBUTORI EIZO AUTORIZZATI SONO STATI AVVERTITI DELLA POSSIBILITÀ DI TALI DANNI. QUESTA ESCLUSIONE INCLUDE ANCHE QUALSIASI RESPONSABILITÀ CHE POSSA INSORGERE DA RECLAMI DI TERZI CONTRO L’ACQUIRENTE ORIGINALE. L’ESSENZA DI QUESTO PROVVEDIMENTO È LIMITARE LA RESPONSABILITÀ POTENZIALE DI EIZO E DEI DISTRIBUTORI DERIVANTE DA QUESTA GARANZIA LIMITATA E/O DALLE VENDITE.

## BEGRÄNSAD GARANTI

EIZO Corporation (nedan kallat "**EIZO**") och EIZOs auktoriserade distributörer (nedan kallade "**Distributörer**") garanterar i enlighet med villkoren i denna begränsade garanti (nedan kallad "**Garantin**") den ursprunglige köparen (nedan kallad den "**Ursprunglige köparen**") som köpte den i dokumentet specificerade produkten (nedan kallad "**Produkten**") från EIZO eller Distributörer, att EIZO eller Distributörer enligt eget gottfinnande kostnadsfritt antingen reparera eller byta ut den defekta Produkten om den Ursprunglige köparen inom Garantiperioden (definieras nedan) upptäcker att (i) Produkten fungerar felaktigt eller skadas under normal användning av Produkten i enlighet med beskrivningen i bruksanvisningen (nedan kallad "**Bruksanvisning**") eller att (ii) Produktens LCD-panel och ljusstyrka inte kan bibehålla den rekommenderade ljusstyrkan som anges i Bruksanvisningen under normal användning av Produkten i enlighet med beskrivningen i Bruksanvisningen.

Giltighetsperioden för denna garanti är fem (5) år från produktens inköpsdatum (kallas härefter "Garantiperioden"), förutsatt att ljusstyrkan på produkten är garanterad endast om produkten har använts inom den rekommenderade ljusstyrka som beskrivs i Användarmanualen och Garantiperioden för ljusstyrkan är begränsad till fem (5) år från produktens inköpsdatum såvida användningstiden är mindre än eller lika med 20 000 timmar (ljusstyrkan är 500cd/m<sup>2</sup> och färgtemperaturen är 7 500K) eller mindre än eller lika med 30 000 timmar (ljusstyrkan är 400cd/m<sup>2</sup> och färgtemperaturen är 7 500K). EIZO och Distributörer ska inte under några villkor ha något annat ansvar än vad som anges i denna garanti gällande Produkten i relation till den Ursprunglige köparen eller tredje part.

EIZO och Distributörer kommer att upphöra med lagerhållning av Produktens delar efter sju (7) år efter att produktionen av dessa delar upphört. Nät skärmen repareras använder EIZO och distributörer reservdelar som uppfyller våra kvalitetsstandarder.

Garantin är endast giltig i de länder där det finns Distributörer. Garantin begränsar inte några av den Ursprunglige köparens lagstadgade rättigheter.

Oavsett andra villkor i denna garanti ska inte EIZO Distributörer under några villkor ha något ansvar i något av de fall som beskrivs nedan:

- (a) När någon bristfällighet hos Produkten kan härledas till att ha uppstått vid frakt, modifiering, ändring, felaktigt handhavande, olycka, felaktig installation, katastrof, felaktigt underhåll och/eller felaktig reparation utförd av tredje part annan än EIZO och Distributörer.
- (b) Alla former av inkompatibilitet hos Produkten på grund av möjliga tekniska innovationer och/eller bestämmelser.
- (c) Alla försämringar av sensorn;
- (d) Alla försämringar av bildens prestanda beroende på förbrukningsdelar så som LCD-panel och/eller bakgrundsbelysning etc. (t.ex. ändringar i ljusstyrkans jämnhet, färg, färgjämnhet, defekta pixlar inklusive brända pixlar etc.).
- (e) Alla försämringar av Produkten orsakat av användning av en högre ljusstyrka än den i Bruksanvisningen rekommenderade ljusstyrkan.
- (f) Alla defekter hos Produkten som orsakats av extern utrustning.
- (g) Alla defekter hos Produkten på vilken det ursprungliga serienumret har ändrats eller avlägsnats.
- (h) All normal försämring av Produkten, speciellt förbrukningsartiklar, tillbehör och/eller yttre delar (t.ex. knappar, roterande delar, kablar, Bruksanvisningen etc.).
- (i) Varje deformation, missfärgning och/eller skevhet av Produktens yttre inklusive ytan på LCD-panelen.

För att erhålla service under denna garanti måste den Ursprunglige köparen (med hänseende till risken för skada och/eller förlust under transport) leverera Produkten till närmaste Distributör med förebetalad frakt, i dess ursprungliga förpackning eller annan fullgod förpackning som ger likvärdigt skydd. Den Ursprunglige köparen måste kunna visa inköpsbevis för Produkten som klargör Produktens inköpsdatum vid begäran av garantiservice.

Garantiperioden för alla utbytta och/eller reparerade produkter under denna garanti skall upphöra vid utgången av den ursprungliga Garantiperioden.

EIZO ELLER DISTRIBUTÖRER ÄR INTE ANSVARIGA FÖR NÅGON FORM AV SKADA ELLER FÖRLUST AV DATA ELLER ANNAN INFORMATION SOM HAR LAGRATS I NÅGON FORM AV MEDIA ELLER ANNAN DEL AV NÅGON PRODUKT SOM HAR RETURNERATS TILL EIZO ELLER DISTRIBUTÖRER FÖR REPARATION.

EIZO OCH DISTRIBUTÖRERNA GARANTERAR INGET, UTTRYCKLIGEN ELLER UNDERFÖRSTÅTT, VAD BETRÄFFAR PRODUKTEN OCH DESS KVALITET, PRESTANDA, SÄLJBARHET ELLER LÄMPLIGHET FÖR NÅGON FORM AV SPECIELL ANVÄNDNING. UNDER INGA OMSTÄNDIGHETER SKALL EIZO ELLER DISTRIBUTÖRERNA HÅLLAS ANSVARIGA FÖR NÅGRA SOM HELST UNDERORDNADE, INDIREKTA, SPECIELLA, DÄRAV FÖLJANDE ELLER ÖVRIGA SKADOR (INKLUSIVE, UTAN BEGRÄNSNING TILL, SKADOR FÖR FÖRLUST AV INKOMST, AVBRUTEN AFFÄRSRÖRELSE, FÖRLUST AV AFFÄRSINFORMATION ELLER ANNAN SÄRSKILD FÖRLUST) SOM UPPSTÅTT SOM ETT RESULTAT AV ANVÄNDNING ELLER OFÖRMÅGA ATT ANVÄNDA PRODUKTEN ELLER I NÅGON FORM AV ANSLUTNING TILL PRODUKTERNA, VARE SIG DETTA GRUNDAS PÅ KONTRAKT, ÅTALBAR HANDLING, FÖRSUMLIGHET, ANSVARSSKYLDIGHET ELLER ANNAT, ÄVEN OM EIZO ELLER DISTRIBUTÖRERNA HAR INFORMERATS BETRÄFFANDE MÖJLIGHET ATT SÅDANA SKADOR FÖRELIGGER. DETTA UNDANTAG OMFATTAR ÄVEN ALL FORM AV ANSVARSSKYLDIGHET SOM KAN UPPSTÅ GENOM EN TREDJE PARTS ANSPRÅK GENTEMOT DEN URSPRUNGLIGE KÖPAREN. GRUNDBESTÄNDSDELEN I BESTÄMMELEN ÄR ATT BEGRÄNSA DET EVENTUELLA ANSVARSTAGANDET FÖR EIZO OCH DISTRIBUTÖRERNA SOM KAN UPPSTÅ GENOM DENNA BEGRÄNSADE GARANTI OCH/ELLER FÖRSÄLJNING.



## ОГРАНИЧЕННАЯ ГАРАНТИЯ

EIZO Corporation (называемая в дальнейшем “EIZO”) и авторизованные EIZO дистрибуторы (называемые в дальнейшем “Дистрибуторы”) гарантируют, в соответствии с условиями и пунктами этой ограниченной гарантии (называемой в дальнейшем “Гарантия”), первичному покупателю (называемому в дальнейшем “Первоначальный покупатель”), который приобрел у EIZO или Дистрибуторов продукт, указанный в этом документе (называемый в дальнейшем “Продукт”), что EIZO или Дистрибуторы на свое усмотрение либо бесплатно отремонтируют, либо бесплатно заменят Продукт, если Первоначальный покупатель признает в пределах Гарантийного срока (определенного ниже), что (i) Продукт неисправен или он поврежден в процессе нормального использования Продукта в соответствии с описанием в инструкции по эксплуатации, прилагаемой к Продукту (называемой в дальнейшем “Руководство пользователя”), или что (ii) панель ЖКД и Яркость Продукта не в состоянии поддерживать рекомендованную яркость, указанную в Руководстве пользователя при условии нормального использования Продукта в соответствии с описанием в Руководстве пользователя.

Гарантийный период (называемый в дальнейшем «Гарантийный период») ограничен сроком пять (5) лет со дня приобретения Продукта. Яркость Продукта может быть гарантирована только в том случае, если Продукт использовался с рекомендованной яркостью, указанной в Руководстве пользователя; Гарантийный период в отношении яркости ограничен периодом пять (5) лет со дня приобретения Продукта при условии, что время его использования не превышает 20 000 часов (для яркости 500 Кд/м<sup>2</sup> и цветовой температуры 7500 К) или 30 000 часов (для яркости 400 Кд/м<sup>2</sup> и цветовой температуры 7500 К). EIZO и Дистрибуторы не несут никакой ответственности и не берут обязательств относительно Продукта по отношению к Первоначальному покупателю или по отношению к любым третьим сторонам, кроме обязательств, оговоренных в этой Гарантии.

EIZO и Дистрибуторы прекратят хранение или складирование любых деталей Продукта по истечении семи (7) лет после прекращения производства таких деталей. В случае ремонта монитора EIZO и Дистрибуторы будут использовать запчасти, которые соответствуют нашим стандартам QC (контроль качества).

Гарантия действительна только в странах или регионах, где расположены Дистрибуторы. Гарантия не ограничивает никакие законные права Первоначального покупателя.

Несмотря на другие условия этой Гарантии EIZO и Дистрибуторы не несут никаких обязательств согласно этой Гарантии в любом из перечисленных ниже случаев:

- (а) Любые дефекты Продукта, вызванные повреждениями при перевозке, модификацией, изменением, неправильным обращением, неправильным использованием, авариями, неправильной установкой, стихийными бедствиями, неправильным уходом и/или неправильным ремонтом третьей стороной, отличной от EIZO или Дистрибуторов;
- (б) Любые несовместимости Продукта из-за технических усовершенствований и/или изменения технических норм;
- (в) Любое повреждение датчика;
- (г) Любое ухудшение качества изображения, вызванное устареванием изнашивающихся частей, таких как ЖК-панель и/или задняя подставка и т. д. (например, изменения цветопередачи, цветовой однородности, дефекты пикселей, включая сгоревшие пиксели, и т. д.);
- (д) Любые ухудшения Продукта, вызванные использованием при яркости, повышенной по сравнению с рекомендованной яркостью, описанной в Руководстве пользователя;
- (е) Любые дефекты Продукта, вызванные внешним оборудованием;
- (ж) Любые дефекты Продукта, при которых оригинальный серийный номер был изменен или удален;
- (з) Любые естественные ухудшения продукта, в частности, вызванные износом расходных частей, принадлежностей и/или приспособлений (например, кнопок, вращающихся частей, кабелей, Руководства пользователя и т.д.); и
- (и) Любые деформации, изменения цвета и/или коробления внешней поверхности продукта, включая поверхность панели ЖКД.

Чтобы получить техническое обслуживание в рамках Гарантии, Первоначальный покупатель должен доставить Продукт местному Дистрибутору, оплатив перевозку, в его оригинальной упаковке или в другой соответствующей упаковке, обеспечивающей равноценную степень защиты, принимая во внимание риск повреждения и/или утерю при транспортировке. При запросе технического обслуживания в рамках Гарантии Первоначальный покупатель должен предоставить свидетельство покупки продукта и даты покупки.

Гарантийный период для любого замененного и/или отремонтированного продукта в рамках Гарантии истекает в конце завершения срока действия оригинального Гарантийного периода.

**EIZO ИЛИ ДИСТРИБУТОРЫ НЕ НЕСУТ ОТВЕТСТВЕННОСТИ ЗА ЛЮБЫЕ ПОВРЕЖДЕНИЯ ИЛИ УТЕРЮ ДАННЫХ ИЛИ ДРУГОЙ ИНФОРМАЦИИ, ХРАНЯЩИХСЯ НА КАКИХ-ЛИБО НОСИТЕЛЯХ ИНФОРМАЦИИ ИЛИ НА ЛЮБЫХ ДРУГИХ ЧАСТЯХ ПРОДУКТА, КОТОРЫЙ ВОЗВРАЩЕН EIZO ИЛИ ДИСТРИБУТОРАМ ДЛЯ РЕМОНТА.**

EIZO и ДИСТРИБУТОРЫ НЕ ДАЮТ НИКАКОЙ ДАЛЬНЕЙШЕЙ ГАРАНТИИ, ВЫРАЖЕННОЙ ИЛИ ПОДРАЗУМЕВАЕМОЙ, ОТНОСИТЕЛЬНО ПРОДУКТА И ЕГО КАЧЕСТВА, ТЕХНИЧЕСКИХ ХАРАКТЕРИСТИК, ТОВАРНОСТИ ИЛИ СООТВЕТСТВИЯ ДЛЯ КАКОГО-ЛИБО ОПРЕДЕЛЕННОГО ИСПОЛЬЗОВАНИЯ. НИ ПРИ КАКИХ УСЛОВИЯХ EIZO ИЛИ ДИСТРИБУТОРЫ НЕ НЕСУТ ОТВЕТСТВЕННОСТИ ЗА ЛЮБОЙ СЛУЧАЙНЫЙ, КОСВЕННЫЙ, СПЕЦИАЛЬНЫЙ, ПОБОЧНЫЙ ИЛИ ИНОЙ УЩЕРБ (ВКЛЮЧАЯ, БЕЗ ОГРАНИЧЕНИЙ, УЩЕРБ ИЗ-ЗА НЕПОЛУЧЕННОЙ ПРИБЫЛИ, ПРЕРЫВАНИЯ БИЗНЕСА, ПОТЕРИ КОММЕРЧЕСКОЙ ИНФОРМАЦИИ ИЛИ ЛЮБЫЕ ДРУГИЕ ФИНАНСОВЫЕ ПОТЕРИ), ВОЗНИКШИЙ ИЗ-ЗА ИСПОЛЬЗОВАНИЯ ИЛИ НЕВОЗМОЖНОСТИ ИСПОЛЬЗОВАТЬ ПРОДУКТ ИЛИ В ЛЮБОЙ ДРУГОЙ СВЯЗИ С ПРОДУКТОМ, ЛИБО ОСНОВАННЫЙ НА КОНТРАКТНЫХ ОТНОШЕНИЯХ, ГРАЖДАНСКИХ ПРАВОНАРУШЕНИЯХ, НЕБРЕЖНОСТИ, ПРИЧИНИЕНИЯ УЩЕРБА ТРЕТЬЕЙ СТОРОНЕ ИЛИ ЧЕМ-ЛИБО ЕЩЕ, ДАЖЕ ЕСЛИ EIZO ИЛИ ДИСТРИБУТОРЫ БЫЛИ УВЕДОМЛЕНЫ О ВОЗМОЖНОСТИ ТАКОГО УЩЕРБА. ЭТО ИСКЛЮЧЕНИЕ ТАКЖЕ ВКЛЮЧАЕТ ЛЮБЫЕ ОБЯЗАТЕЛЬСТВА, КОТОРЫЕ МОГУТ ВОЗНИКНУТЬ В РЕЗУЛЬТАТЕ ТРЕБОВАНИЙ ТРЕТЬЕЙ СТОРОНЫ В ОТНОШЕНИИ ПЕРВОНАЧАЛЬНОГО ПОКУПАТЕЛЯ. СУЩЕСТВОМ ЭТОГО ПОЛОЖЕНИЯ ЯВЛЯЕТСЯ ОГРАНИЧЕНИЕ ПОТЕНЦИАЛЬНОЙ ОТВЕТСТВЕННОСТИ EIZO И ДИСТРИБУТОРОВ, ВОЗНИКАЮЩЕЙ ИЗ-ЗА ЭТОЙ ОГРАНИЧЕННОЙ ГАРАНТИИ И/ЛИ ПРОДАЖ.

## 有限责任保证书

EIZO Corporation (以下简称“EIZO”)和 EIZO 授权的经销商 (以下简称“经销商”), 接受并依照本有限责任保证书 (以下简称“保证书”)之条款, 向从 EIZO 和经销商购买本文中所规定产品 (以下简称“产品”)的原买方 (以下称“原买方”)提供保证:在保证期内 (规定如下), 如果原买方发现 (i) 按本产品所附使用说明书 (以下简称“用户手册”)所述方式正常使用本产品过程中, 本产品出现故障或损坏 或 (ii) 按用户手册所述方式正常使用本产品过程中, 本产品的液晶显示屏 (LCD) 及亮度未能达到用户手册中所述的推荐亮度时, EIZO 和经销商根据其独立的判断免费修理或更换该产品。

本保证期限定为仅按照用户手册所描述的推荐亮度使用本产品时保证其亮度的条件下自购买本产品之日起的五 (5) 年 (以下简称“保证期限”), 亮度的保证期限定为本产品的使用时间在 20000 小时以下 (含 20000 小时) (亮度为 500cd/m<sup>2</sup>, 色温为开氏温度 7500) 或 30000 小时以下 (含 30000 小时) (亮度为 400cd/m<sup>2</sup>, 色温为开氏温度 7500) 的条件下自购买本产品之日起五 (5) 年。EIZO 和经销商将不向原买方或任何第三方承担本保证书所规定之外的与本产品有关任何责任或义务。

本产品的任何部件停产七 (7) 年后, EIZO 和经销商将不再保留或保管任何这类部件。维修显示器时, EIZO 与经销商将使用符合我方质量控制标准的替换零件。

本保证书仅对于设有经销商的国家或地区有效。本保证书并不限定原买方的任何法律权利。

无论本保证书的任何其他条款如何规定, 对于任何下列情况之一, EIZO 和经销商将不承担本保证书规定责任:

- (a) 由于运输损害、改装、改动、滥用、误用、意外事故、错误安装、灾害、维护不善和 / 或由除 EIZO 和经销商以外的第三方进行不适当的修理造成本产品的任何故障。
- (b) 由于可能发生的技术变更和 / 或调整造成本产品的任何不兼容性。
- (c) 传感器的任何劣化;
- (d) 由于诸如液晶显示屏 (LCD) 和 / 或背景照明等消耗品部件的老化造成的任何显示性能低劣 (如亮度均一性变化、色彩变化、色彩均一性变化、包括烧伤像素在内的像素缺陷等)。
- (e) 由于在比用户手册所推荐亮度更高的亮度下使用对本产品所造成的任何老化。
- (f) 因外部设备造成本产品的任何故障。
- (g) 因本产品的原序号被改变或消除造成本产品的任何故障。
- (h) 本产品的任何正常老化, 尤其是消耗品、附件和 / 或附加装置 (如按钮、旋转部件、电缆、用户手册等)、以及
- (i) 本产品表面包括液晶显示屏 (LCD) 表面的任何变形、变色和 / 翘曲。

为了获得本保证书规定的服务, 原买方必须使用原包装或其他具有同等保护程度的适当包装将本产品运送到当地的经销商, 并且预付运费, 承担运输中的损坏和 / 或损失的风险。要求提供本保证书规定的服务时, 原买方必须提交购买本产品和标明此购买日期的证明。

按本保证书规定进行了更换和 / 或修理的任何产品的保证期限, 将在原保证期限结束时终止。

在返回给 EIZO 和经销商进行修理后, 任何产品的任何媒体或任何部件中储存的数据或其他信息发生任何损坏或损失, 对此 EIZO 和经销商将不承担责任。

对于本产品及其质量、性能、可销售性以及对于特殊用途的适合性, EIZO 和经销商不提供其他任何明示或暗示的保证。因使用本产品或无法使用本产品或因与本产品有任何关系 (无论是否根据合同) 而造成: 任何附带的、间接的、特殊的、随之发生的或其他的损害 (包括但不限于: 利润损失、业务中断、业务信息丢失或其他任何金钱损失) 以及侵权行为、过失、严格赔偿责任或其他责任, 即使已经向 EIZO 和经销商提出了发生这些损害的可能性, 对此 EIZO 和经销商概不承担责任。本免责条款还包括因第三方向原买方提出索赔而可能发生的任何责任。本条款的本质是限定由于本有限责任保证书和 / 或销售本产品所发生的 EIZO 和经销商的潜在责任。

# Recycling Information

---

## Recycling Information

This product, when disposed of, is supposed to be collected and recycled according to your country's legislation to reduce environmental burden. When you dispose of this product, please contact a distributor or an affiliate in your country.

The contact addressees are listed on the EIZO website below.

<http://www.eizoglobal.com>

For recycling information for customers in Switzerland, please refer to the following website.

<http://www.swico.ch>

## Informationen zum Thema Recycling

Dieses Produkt muss gemäß den Vorschriften Ihres Landes zur Entlastung der Umwelt recyclet werden. Wenden Sie sich bei der Entsorgung dieses Produkts an einen Verteiler oder eine Tochtergesellschaft in Ihrem Land.

Die Adressen zur Kontaktaufnahme sind auf der unten angegebenen Website von EIZO aufgeführt.

<http://www.eizoglobal.com>

Kunden in der Schweiz entnehmen Informationen zum Recycling der folgenden Website:

<http://www.swico.ch>

## Informations sur le recyclage

Ce produit doit être jeté aux points de collecte prévus à cet effet et recyclé conformément à la législation de votre pays, afin de réduire l'impact sur l'environnement. Lorsque vous jetez ce produit, veuillez contacter un distributeur ou une société affiliée de votre pays.

Les adresses des distributeurs sont répertoriées sur le site Web EIZO ci-dessous.

<http://www.eizoglobal.com>

Pour les clients en Suisse, veuillez consulter le site Web suivant afin d'obtenir des informations sur le recyclage.

<http://www.swico.ch>

## Información sobre reciclaje

Este producto debe desecharse y reciclarse según la legislación del país para reducir el impacto medioambiental. Cuando desee deshacerse de este producto, póngase en contacto con un distribuidor o una filial de su país.

Encontrará las direcciones de contacto en el sitio web de EIZO que se indica a continuación.

<http://www.eizoglobal.com>

## Informazioni sul riciclaggio

Per lo smaltimento e il riciclaggio del presente prodotto, attenersi alle normative vigenti nel proprio paese per ridurre l'impatto ambientale. Per lo smaltimento, rivolgersi ad un distributore o un affiliato presenti nel proprio paese.

Gli indirizzi sono elencati nel sito Web EIZO riportato di seguito.

<http://www.eizoglobal.com>

Per informazioni sul riciclaggio per i clienti in Svizzera, consultare il sito Web riportato di seguito.

<http://www.swico.ch>

## Återvinningsinformation

När denna produkt kasseras ska den hanteras och återvinnas enligt landets föreskrifter för att reducera miljöpåverkan. När du kasserar produkten ska du kontakta en distributör eller representant i ditt land.

Kontaktadresserna listas på EIZO-webbplatsen nedan.

<http://www.eizoglobal.com>

## Πληροφορίες ανακύκλωσης

Το προϊόν αυτό, όταν απορρίπτεται, πρέπει να συλλέγεται και να ανακυκλώνεται σύμφωνα με τη νομοθεσία της χώρας σας έτσι ώστε να μην επιβαρύνει το περιβάλλον. Για να απορρίψετε το προϊόν, επικοινωνήστε με έναν αντιπρόσωπο ή μια θυγατρική εταιρεία στη χώρα σας.

Οι διευθύνσεις επικοινωνίας αναγράφονται στην τοποθεσία web της EIZO παρακάτω.

<http://www.eizoglobal.com>

## Сведения по утилизации

По истечении срока службы данного продукта его следует принести на сборный пункт и утилизировать в соответствии с действующими предписаниями в вашей стране, чтобы уменьшить вредное воздействие на окружающую среду. Прежде чем выбросить данный продукт, обратитесь к дистрибьютору или в местное представительство компании в вашей стране.

Контактные адреса можно найти на веб-узле EIZO.

<http://www.eizoglobal.com>

## Informatie over recycling

Wanneer u dit product wilt weggooien, moet het uit milieu-overwegingen worden verzameld en gerecycled volgens de betreffende wetgeving van uw land. Wanneer u dit product wilt weggooien, moet u contact opnemen met een distributeur of een partner in uw land.

De contactadressen worden vermeld op de volgende EIZO-website.

<http://www.eizoglobal.com>

## Informação sobre reciclagem

Este produto, quando o deitar fora, deve ser recolhido e reciclado de acordo com a legislação do seu país para reduzir a poluição. Quando deitar fora este produto, contacte um distribuidor ou uma filial no seu país.

Os endereços de contacto estão listados no website do EIZO, abaixo.

<http://www.eizoglobal.com>

## Oplysninger om genbrug

Denne produkt forventes ved bortskaffelse at blive indsamlet og genbrugt i overensstemmelse med lovgivningen i dit land for at reducere belastningen af miljøet. Når du bortskaffer denne produkt, skal du kontakte en distributør eller et tilknyttet selskab i dit land.

Adresserne på kontaktpersonerne er angivet på EIZO's websted nedenfor.

<http://www.eizoglobal.com>

## Kierrätystä koskevia tietoja

Tuote tulee hävittää kierrättämällä maan lainsäädännön mukaisesti ympäristön kuormittumisen vähentämiseksi. Kun hävität tuotteen, ota yhteyttä jälleenmyyjään tai tytäryhtiöön maassasi.

Yhteystiedot löytyvät EIZOn Internet-sivustolta.

<http://www.eizoglobal.com>

## Wykorzystanie surowców wtórnych

Ten produkt po zużyciu powinien być zbierany i przetwarzany zgodnie z krajowymi przepisami dotyczącymi ochrony środowiska. Wyrzucając ten produkt, należy skontaktować się z lokalnym dystrybutorem lub partnerem. Adresy kontaktowe można znaleźć we wskazanej poniżej witrynie internetowej firmy EIZO.

<http://www.eizoglobal.com>

## Informace o recyklaci

Při likvidaci produktu musí být produkt vyzvednut a recyklován podle zákonů příslušné země, aby nedocházelo k zatěžování životního prostředí. Zbavujete-li se produktu, kontaktujte distributora nebo pobočku ve své zemi. Kontaktní adresy jsou uvedeny na následující webové stránce společnosti EIZO.  
<http://www.eizoglobal.com>

## Ringlussevõtu alane teave

Keskkonnakoormuse vähendamiseks tuleks kasutatud tooted kokku koguda ja võtta ringlusse vastavalt teie riigi seadustele. Kui kõrvaldate käesoleva toote, võtke palun ühendust turustaja või filiaaliga oma riigis. Kontaktisikud on toodud EIZO veebilehel järgmisel aadressil:  
<http://www.eizoglobal.com>

## Újrahasznosítási információ

Jelen terméket, amikor eldobjuk, az illető ország törvényei alapján kell összegyűjteni és újrahasznosítani, hogy csökkentsük a környezetet terhelését. Amikor ezt a terméket eldobja, kérjük lépjen kapcsolatba egy országon belüli forgalmazóval vagy társvállalkozással.  
A kapcsolat címei az EIZO alábbi weboldalán találhatók felsorolva:  
<http://www.eizoglobal.com>

## Podatki o recikliranju

Ob koncu uporabe odslužen izdelek izročite na zbirno mesto za recikliranje v skladu z okoljevarstveno zakonodajo vaše države. Prosimo, da se pri odstranjevanju izdelka obrnete na lokalnega distributerja ali podružnico.  
Kontaktne naslovi so objavljeni na spodaj navedenih spletnih straneh EIZO:  
<http://www.eizoglobal.com>

## Informácie o recyklácii

Pri likvidácii musí byť tento výrobok recyklovaný v súlade s legislatívou vašej krajiny, aby sa znížilo zaťaženie životného prostredia. Keď sa chcete zbaviť tohto výrobku, kontaktujte prosím distribútora alebo pobočku vo vašej krajine.  
Zoznam kontaktných adries je uvedený na nasledovnej webovej stránke firmy EIZO:  
<http://www.eizoglobal.com>

## Pārstrādes informācija

Utilizējot šo produktu, tā savākšana un pārstrāde veicama atbilstoši jūsu valsts likumdošanas prasībām attiecībā uz slodzes uz vidi samazināšanu. Lai veiktu šī produkta utilizāciju, sazinieties ar izplatītāju vai pārstāvniecību jūsu valstī.  
Kontaktadrese ir norādītas zemāk minētajā EIZO tīmekļa vietnē.  
<http://www.eizoglobal.com>

## Informacja apie gražinamąjį perdirbimą

Šalinant (išmetant) šiuos gaminius juos reikia surinkti ir perdirbti gražinamuoju būdu pagal jūsų šalies teisės aktus, siekiant sumažinti aplinkos teršimą. Kai reikia išmesti šį gaminį, kreipkitės į jūsų šalyje veikiančią gaminių pardavimo atstovybę arba jos filiaalą.  
Kontaktiniai adresatai nurodyti EIZO interneto svetainėje.  
<http://www.eizoglobal.com>

## Информация относно рециклиране

При изхвърлянето на този продукт се предлага събирането и рециклирането му съобразно законите на вашата страна за да се намали замърсяването на околната среда. Когато искате да се освободите от този продукт, моля свържете се с търговския му представител или със съответните органи отговарящи за това във вашата страна.

Данните за връзка с нас са описани на следния Интернет сайт на EIZO:  
<http://www.eizoglobal.com>

## Informație referitoare la reciclare

Acest produs, când debarasat, trebuie colectat și reciclat conform legislației țării respective ca să reducem sarcina mediului. Când se debarasează de acest produs, vă rugăm să contactați un distribuitor sau un afiliat al țării respective.

Adresele de contact le găsiți pe pagina de web al EIZO:  
<http://www.eizoglobal.com>

## معلومات عن إعادة التدوير

عند التخلص من هذا المنتج، من الضروري تجميعه وإعادة تدويره وفقاً للقوانين المتبعة في بلدك لتقليل العبء المسلط على البيئة. عندما تتخلص من هذا المنتج، يرجى الاتصال بموزع أو طرف منتسب إليه في بلدك. عناوين الاتصال مدرجة في موقع ايزو EIZO ادناه على شبكة الانترنت.

<http://www.eizoglobal.com>

## Geri Dönüşüm Bilgisi

Bu ürünün, atılacağı zaman, ülkenizin çevre kirliliğinin azaltılması konusundaki mevzuatına göre toplanması ve yeniden değerlendirilmesi gerekmektedir. Ürünü atacağınız zaman lütfen ülkenizdeki bir distribütör veya ilgili kuruluşla temasa geçiniz.

İrtibat adresleri aşağıdaki EIZO web sitesinde verilmiştir.  
<http://www.eizoglobal.com>

