

# User's Manual

## ColorEdge<sup>®</sup> CG245W

Calibration Color LCD Monitor

### **Important**

Please read PRECAUTIONS, this User's Manual and Setup Guide (separate volume) carefully to familiarize yourself with safe and effective usage.

- 
- Please read the Setup Guide (separate volume)
  - The latest User's Manual is available for download from our site:  
<http://www.eizo.com>
- 



## [Location of Caution Statement]

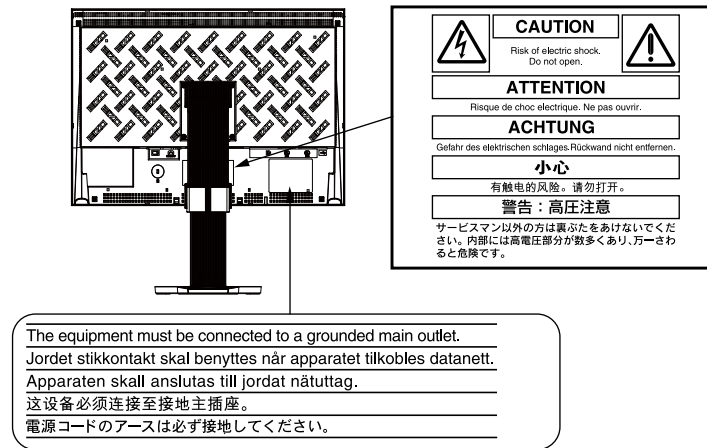

Product specifications may vary with sales areas.

Confirm the specifications in the manual written in the language of the region of purchase.

This product has acquired TCO standard that relates to safety, ergonomics, environment and so forth of office equipment. For overview of the TCO, refer to our website.

<http://www.eizo.com>

---

Copyright© 2010 EIZO NANA O CORPORATION All rights reserved.

No part of this manual may be reproduced, stored in a retrieval system, or transmitted, in any form or by any means, electronic, mechanical, or otherwise, without the prior written permission of EIZO NANA O CORPORATION.

EIZO NANA O CORPORATION is under no obligation to hold any submitted material or information confidential unless prior arrangements are made pursuant to EIZO NANA O CORPORATION's receipt of said information.

Although every effort has been made to ensure that this manual provides up-to-date information, please note that EIZO monitor specifications are subject to change without notice.

---

Adobe is a registered trademark of Adobe Systems Incorporated in the United States and other countries.

Apple, Macintosh, Mac OS and ColorSync are registered trademarks of Apple Inc.

VGA is a registered trademark of International Business Machines Corporation.

Windows and Windows Vista are registered trademarks of Microsoft Corporation.

The round gothic bold bit map font used for this product is designed by Ricoh.

DisplayPort icon and VESA are trademarks and registered trademarks of Video Electronics Standards Association.

PowerManager, ColorNavigator and UniColor Pro are trademarks of EIZO NANA O CORPORATION.

EIZO, EIZO Logo and ColorEdge are registered trademarks of EIZO NANA O CORPORATION in Japan and other countries.



## Notice for this monitor

---

Aside from creating documents, viewing multimedia content, and other general purposes, this product is also suited to applications such as graphics creation and digital photo processing, where accurate color reproduction is a priority.

---

This product has been adjusted specifically for use in the region to which it was originally shipped. If the product is used outside the region, it may not operate as specified in the specifications.

---

This product may not be covered by warranty for uses other than those described in this manual.

---

The specifications noted in this manual are only applicable for power cords and signal cables specified by us.

---

Use optional products manufactured or specified by us with this product.

---

As it takes about 30 minutes for the performance of electrical parts to stabilize, adjust the monitor 30 minutes or more after the monitor power has been turned on.

---

In order to suppress the luminosity change by long-term use and to maintain the stable luminosity, use of a monitor in lower brightness is recommended.

---

When the screen image is changed after displaying the same image for extended periods of time, an afterimage may appear. Use the screen saver or timer to avoid displaying the same image for extended periods of time.

---

Periodic cleaning is recommended to keep the monitor looking new and to prolong its operation lifetime. (Refer to “[Cleaning](#)” on the next page.)

---

The LCD panel is manufactured using high-precision technology. However, note that the appearance of any missing pixels or lit pixels does not indicate damage to the LCD monitor. Percentage of effective pixels : 99.9994% or higher.

---

The backlight of the LCD panel has a fixed life span. When the screen becomes dark or begins to flicker, please contact your dealer.

---

Do not press on the panel or edge of the frame strongly, as this may result in the display malfunction, such as the interference patterns, etc. If pressure is continually applied to the LCD panel, it may deteriorate or damage your LCD panel. (If the pressure marks remain on the LCD panel, leave the monitor with a white or black screen. The symptom may disappear.)

---

Do not scratch or press on the panel with any sharp objects, such as a pencil or pen as this may result in damage to the panel. Do not attempt to brush with tissues as this may scratch the LCD panel.

---

When the monitor is cold and brought into a room or the room temperature goes up quickly, dew condensation may occur inside and outside the monitor. In that case, do not turn the monitor on and wait until dew condensation disappears, otherwise it may cause some damages to the monitor.

---

---

## Cleaning

---

### **Attention**

- Never use any solvents or chemicals, such as thinner, benzene, wax, alcohol, disinfectant, and abrasive cleaner, which may damage the cabinet or LCD panel.
- 

### ● **LCD Panel**

- Clean the LCD panel with a soft cloth such as cotton cloth or lens cleaning paper.
- If necessary, stubborn stains can be removed by using the provided ScreenCleaner, or moistening part of a cloth with water to enhance its cleaning power.

### ● **Cabinet**

- Clean the cabinet with a soft cloth dampened with a little mild detergent.

## To use the monitor comfortably

---

- An excessively dark or bright screen may affect your eyes. Adjust the brightness of the monitor according to the environmental conditions.
- Staring at the monitor for a long time tires your eyes. Take a 10-minute rest every hour.

# CONTENTS

<b>Cover</b> .....	<b>1</b>	<b>2-6. Configuring moving image performance [Overdrive]</b> .....	<b>26</b>
Notice for this monitor .....	3	<b>Chapter 3 Setting Monitor</b> .....	<b>27</b>
<b>CONTENTS</b> .....	<b>5</b>	<b>3-1. Enabling/Disabling Mode Selection [Mode Preset]</b> .....	<b>27</b>
<b>Chapter 1 Introduction</b> .....	<b>7</b>	<b>3-2. Locking Buttons [Key Lock]</b> .....	<b>27</b>
<b>1-1. Features</b> .....	<b>7</b>	<b>3-3. Setting the EIZO Logo Display [Logo]</b> .....	<b>28</b>
<b>1-2. Controls and Functions</b> .....	<b>8</b>	<b>3-4. Setting Orientation [Orientation]</b> .....	<b>28</b>
<b>1-3. Utility Disk</b> .....	<b>9</b>	<b>3-5. Setting Language [Language]</b> .....	<b>29</b>
● Disk contents and software overview .....	9	<b>3-6. Setting Range of Frequency [Signal Bandwidth]</b> .....	<b>29</b>
● To use ColorNavigator .....	9	<b>3-7. Setting the Display Position of the Adjustment Menu [Menu Position]</b> .....	<b>30</b>
<b>1-4. Basic Operation and Functions</b> .....	<b>10</b>	<b>3-8. Sets the brightness of the front buttons [Indicator]</b> .....	<b>30</b>
Basic operation of menu .....	10	<b>3-9. Restoring the Default Setting</b> .....	<b>31</b>
Showing Button Guide .....	11	● To reset color adjustment values [Color Reset] .....	31
Functions .....	12	● To reset all adjustments to the factory default settings [All Reset] .....	31
<b>Chapter 2 Adjusting Screen</b> .....	<b>14</b>	<b>Chapter 4 SelfCalibration</b> .....	<b>32</b>
<b>2-1. Setting Screen Resolution</b> .....	<b>14</b>	<b>4-1. Executing SelfCalibration [Calibration]</b> .....	<b>32</b>
Compatible Resolutions/Frequencies .....	14	<b>4-2. Checking Calibration Results [Result]</b> .....	<b>32</b>
Setting Resolution .....	15	<b>4-3. Setting Calibration Details [Setting]</b> .....	<b>33</b>
● Windows 7 .....	15	● Setting the mode to execute SelfCalibration [Mode Selection] .....	33
● Windows Vista .....	15	● Setting the calibration targets .....	33
● Windows XP .....	15	● Setting the monitor date and time [Clock Adjustment] .....	34
● Mac OS X .....	15	● Setting the calibration schedule [Schedule] .....	35
<b>2-2. Expanding Signal Output Range [Range Extension]</b> .....	<b>16</b>	<b>Chapter 5 Power Saving Function</b> .....	<b>36</b>
<b>2-3. Displaying Screen Correctly</b> .....	<b>16</b>	<b>5-1. Setting the Power Saving [Power Save]</b> .....	<b>36</b>
Digital Input .....	16	<b>Chapter 6 Troubleshooting</b> .....	<b>37</b>
Analog Input .....	16	<b>Chapter 7 Reference</b> .....	<b>40</b>
<b>2-4. Color Adjustment</b> .....	<b>20</b>	<b>7-1. Attaching an Arm</b> .....	<b>40</b>
● To select the display mode (Color Mode) .....	20	<b>7-2. Connecting More than Two PCs to the Monitor</b> .....	<b>41</b>
● To perform advanced adjustments .....	21	● To switch the input signal .....	41
● Adjustment items in each mode .....	21	● To set input signal selection [Input Selection] .....	42
● To adjust the brightness [Brightness] .....	22	<b>7-3. Making Use of USB (Universal Serial Bus)</b> .....	<b>43</b>
● To adjust the contrast [Contrast] .....	22	● Required System Environment .....	43
● To adjust the color temperature [Temperature] .....	22	● Connection Procedure (Setup of USB Function) .....	43
● To adjust the gamma value [Gamma] .....	23		
● To adjust the hue [Hue] .....	23		
● To adjust the color saturation [Saturation] .....	23		
● To enhance the outline of the image [Outline Enhancer] .....	24		
● To adjust the gain value [Gain] .....	24		
● To adjust the black level [Black Level] .....	24		
● To adjust six colors [6 Colors] .....	25		
<b>2-5. Displaying Lower Resolutions</b> .....	<b>26</b>		
● To change screen size [Screen Size] .....	26		

# CONTENTS

<b>7-4. Displaying Monitor Information .....</b>	<b>44</b>
● Displaying signal information [Signal Info] .....	44
● Displaying monitor information [Monitor Info]...	44
<b>7-5. Specifications .....</b>	<b>45</b>
<b>7-6. Glossary .....</b>	<b>49</b>
<b>7-7. Preset Timing.....</b>	<b>52</b>
<b>About TCO' 03 .....</b>	<b>53</b>
<b>FCC Declaration of Conformity .....</b>	<b>54</b>
<b>HinweiseHinweise zur Auswahl des richtigen</b>	
<b>Schwenkarms für Ihren Monitor .....</b>	<b>55</b>
<b>Hinweis zur Ergonomie .....</b>	<b>55</b>
<b>LIMITED WARRANTY.....</b>	<b>56</b>

# Chapter 1 Introduction

Thank you very much for choosing an EIZO Color Monitor.

## 1-1. Features

- 24" wide format LCD
- Wide color gamut of 98% of Adobe RGB
- Applicable to the resolution of 1920 dots x 1200 lines
- HDCP (High-bandwidth Digital Content Interface)
- Frame Synchronous mode supported (23.75 - 30.5Hz, 47.5 - 61Hz)
- Applicable to DisplayPort (applicable to 8 bit or 10 bit, not applicable to audio signals)
- 3 signal input terminals (DVI-I x 2, DisplayPort x 1)
- Color Mode function reproduces color gamut and gamma compliant with Adobe®RGB, [EBU/REC709/SMPTE-C] broadcasting standards, as well as [DCI] digital cinema standards.  
“2-4. Color Adjustment” (page 20)
- Attaching the “Adjustment Certificate” to describe the grayscale and uniformity characteristics of the monitor individually
- Portrait/Landscape display available (rotate 90 degrees clockwise)
- Monitor hood attached
- The front buttons light to improve operability in dark places.  
“3-8. Sets the brightness of the front buttons [Indicator]” (page 30)
- This product is equipped with a built-in color measurement sensor, and supports SelfCalibration in which the monitor executes calibration independently.  
“Chapter 4 SelfCalibration” (page 32)
- The provided “ColorNavigator” calibration software enables you to calibrate monitor characteristics and generate color profiles  
“1-3. Utility Disk” (page 9)
- Color Vision Deficiency Simulation Software “UniColor Pro” supported  
This software can be downloaded from <http://www.eizo.com>
- Power saving function  
This product is equipped with power saving function.
  - Power Consumption when main power switch is Off: 0W  
Equipped with main power switch.  
Turning off the main power switch completely shuts off power supply to the monitor while the monitor is not used.



### CAUTION

#### Be careful of the following points when using the monitor hood.



- Do not carry the monitor with the hood attached.  
While carrying the monitor, the hood may fall or slip off, which may result in injury or equipment damage.



- Do not place any objects on the hood.  
If the hood falls or slips off or the monitor falls over, it may result in injury or equipment damage.

---

#### Attention

- Storing or using the monitor at a temperature of under 30°C and a humidity of under 70% is recommended, or it may affect the measurement accuracy of the built-in sensor. Avoid storing or using the sensor where it may be exposed to direct sunlight.
-

**NOTE**

- This monitor supports the Portrait/Landscape display. This function allows you to change the orientation of the Adjustment menu when using the monitor screen in vertical display position. (Refer to “3-4. Setting Orientation [Orientation]” (page 28).)
- For using the monitor with “Portrait” position, the graphics board supporting portrait display is required. When using the monitor with “Portrait” position, the setting needs to be changed depending on the graphics board used in your PC. Refer to the manual of the graphics board for details.

## 1-2. Controls and Functions

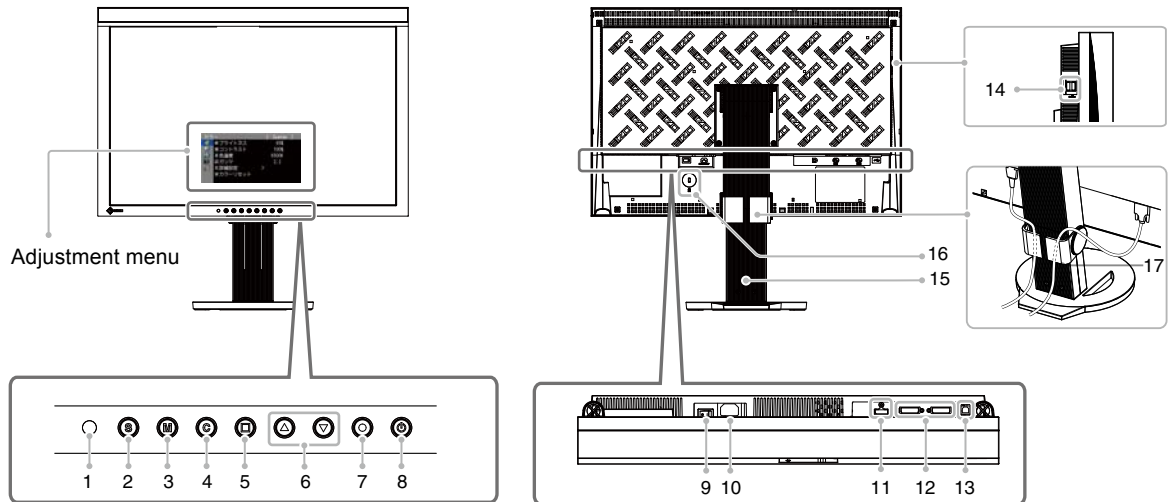

1	Ambient Light Sensor	Measures ambient light.
2	Ⓢ button	Switches input signals for display images.
3	Ⓜ button	Allows you to switch the Color Mode.
4	Ⓒ button	Displays the SelfCalibration menu.
5	Ⓟ button	Cancels the adjustment/setting or exit the adjustment menu.
6	⬆️⬇️ buttons	Chooses an adjustment item or increases/decreases adjusted values for advanced adjustments using the Adjustment menu.
7	Ⓞ button	Displays the Adjustment menu, determines an item on the menu screen, and saves values adjusted.
8	Ⓚ button	Turns the power on or off. Indicates monitor's operation status. Blue : Operating Flashing blue : In the following cases, this notifies that recalibration (2 times for each) is required. <ul style="list-style-type: none"> <li>• When the timer is set in ColorNavigator (CAL mode)</li> <li>• When the SelfCalibration schedule is set</li> </ul> Orange : Power saving Off : Power off
9	Main Power switch	Turns the main power on or off.
10	Power connector	Connects the power cord.
11	Input signal connectors	Display Port Connector x 1
12	Input signal connectors	DVI-I Connector x 2
13	USB port (Up)	Connects the USB cable to use the software that needs USB connection, or to use USB Hub function.
14	USB port (Down)	Connects a peripheral USB drive.
15	Stand	Used to adjust the height and angle of the monitor screen.
16	Security lock slot	Complies with Kensington's MicroSaver security system.
17	Cable holder	Covers the monitor cables.



## 1-3. Utility Disk

An “EIZO LCD Utility Disk” (CD-ROM) is supplied with the monitor. The following table shows the disk contents and the overview of the software programs.

### ● Disk contents and software overview

The disk includes application software programs for adjustment, and User’s Manual. Refer to “Readme.txt” or the “read me” file on the disk for software startup procedures or file access procedures.

Item	Overview	For Windows	For Macintosh
A “Readme.txt” or “read me” file		√	√
ColorNavigator	An application software for calibrating monitor characteristics and generating ICC profiles (for Windows) and Apple ColorSync profiles (for Macintosh). (A PC must be connected to the monitor with the supplied USB cable.) Refer to the description later.	√	√
Screen Adjustment Utility	Monitor pattern display software used when adjusting the image of the analog input signal manually.	√	–
Screen adjustment pattern files	Used when adjusting the image of the analog signal input manually. If the Screen Adjustment Utility is not applicable to your PC, use this pattern files to adjust the image.	√	–
User’s Manual (PDF file)		√	√

### ● To use ColorNavigator

Refer to the corresponding User’s Manual on the CD-ROM disk in order to install and use the software. When using this software, you will need to connect a PC to the monitor with the supplied USB cable. For more information refer to the [“7-3. Making Use of USB \(Universal Serial Bus\)”](#) (page 43).

# 1- 4. Basic Operation and Functions

## Basic operation of menu

### 1 Displaying Menu

#### Displaying Adjustment menu

Press **⊙**. The adjustment menu appears.

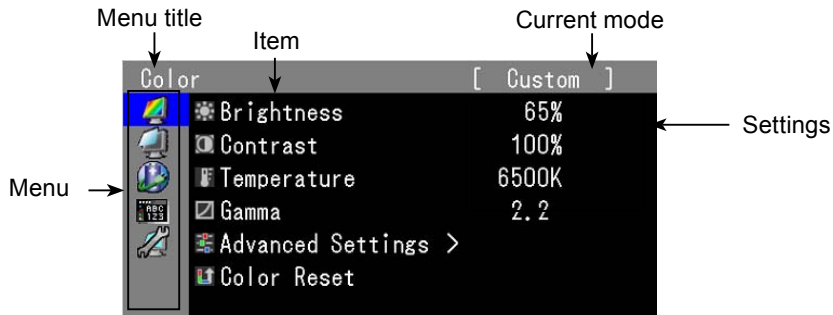

#### Displaying SelfCalibration menu

Press **Ⓢ**, The SelfCalibration menu appears.

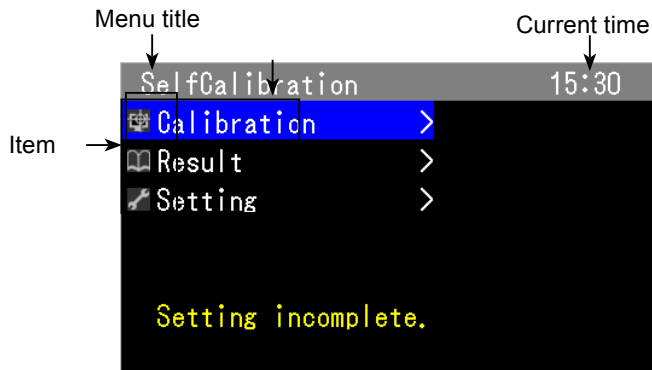

### 2 Adjusting/Setting

1. Choose a menu to adjust/set with **⬆**/**⬇**, and press **⊙**.

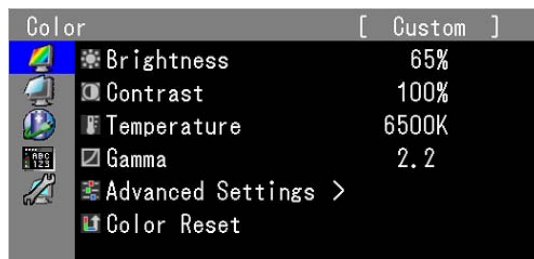

2. Choose an item to adjust/set with **⬆**/**⬇**, and press **⊙**.

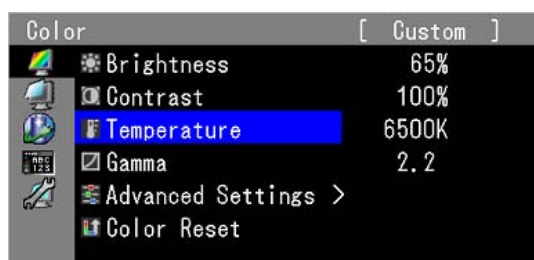

3. Adjust/set the selected item with ▲▼, and press ○.

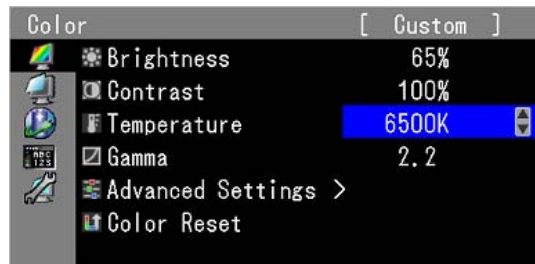

### 3 Exiting

Press ○ a few times.

The adjustment menu finishes.

## Showing Button Guide

Press the front buttons (except ○ button), the button guide appears above the button. (When using the monitor with "Portrait" position, the button guide appears next to the button.)

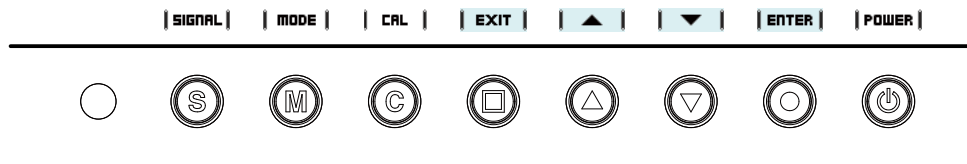





#### Tips

- The button guide will continue to appear while the Adjustment menu or Mode menu is showing.
- The button guide is displayed differently depending on the selected menu or status.
- In CAL mode, although Button Guide are displayed above the ▲ and ▼ buttons, the brightness cannot be adjusted.









# Functions

The following table shows all the Adjustment menu's adjustment and setting menus.

Main Menu	Item	Adjusting/Setting	
Color 	Brightness	"2-4. Color Adjustment" (page 20)	
	Contrast		
	Temperature		
	Gamma		
	Advanced Settings		Hue
	Saturation		
	Outline Enhancer		
	Gain		
Black Level	"3-9. Restoring the Default Setting" (page 31)		
6 Colors			
Color Reset			
Screen 	Screen Size	"2-5. Displaying Lower Resolutions" (page 26)	
	Range Extension	"2-2. Expanding Signal Output Range [Range Extension]" (page 16)	
	Analog Adjustment	"2-3. Displaying Screen Correctly" (page 16)	
	Auto Adjustment		
	Range Adjustment		
	Clock		
	Phase		
	Hor.Position		
Ver.Position			
PowerManager 	Power Save	"5-1. Setting the Power Saving [Power Save]" (page 36)	
	Indicator	"3-8. Sets the brightness of the front buttons [Indicator]" (page 30)	
Menu Settings 	Language	"3-5. Setting Language [Language]" (page 29)	
	Orientation	"3-4. Setting Orientation [Orientation]" (page 28)	
	Menu Position	"3-7. Setting the Display Position of the Adjustment Menu [Menu Position]" (page 30)	
Tools 	Input Selection	"7-2. Connecting More than Two PCs to the Monitor" (page 41)	
	Overdrive	"2-6. Configuring moving image performance [Overdrive]" (page 26)	
	Mode Preset	"3-1. Enabling/Disabling Mode Selection [Mode Preset]" (page 27)	
	Signal Info	"7-4. Displaying Monitor Information" (page 44)	
	Monitor Info		
	All Reset	"3-9. Restoring the Default Setting" (page 31)	

\* The adjusting/setting function on the <Color> menu depend on the selected Color mode (page 21). The above table shows the sub menus when the "Custom" mode is selected (See "2-4. Color Adjustment" (page 20)).

The following table shows all SelfCalibration menu's adjustment and setting menus.

Main Menu	Item	Adjusting/Setting	
SelfCalibration	 Calibration	<a href="#">"4-1. Executing SelfCalibration [Calibration]"</a> <a href="#">(page 32)</a>	
	 Result	 Calibration Result  Ambient Light	<a href="#">"4-2. Checking Calibration Results [Result]"</a> <a href="#">(page 32)</a>
	 Setting	 Mode Selection	<a href="#">"4-3. Setting Calibration Details [Setting]"</a> <a href="#">(page 33)</a>
		 Target	
		 Schedule	
		 Clock Adjustment	

# Chapter 2 Adjusting Screen

## 2-1. Setting Screen Resolution

### Compatible Resolutions/Frequencies

The monitor supports the following resolutions.

#### Analog Input

Resolution	Display Mode	Frequency	Dot Clock
640×480	VGA	60Hz	170MHz (Max.)
720×400	VGA TEXT	70Hz	
800×600	VESA	60Hz	
1024×768	VESA	60Hz	
1280×960	VESA	60Hz	
1280×1024	VESA	60Hz	
1600×1200	VESA	60Hz	
1680×1050	VESA CVT	60Hz	
1920×1080	CEA-861	60Hz	
1920×1200*	VESA CVT RB	60Hz	

#### Digital Input (DVI/DisplayPort)

Resolution	Display Mode	Frequency	Dot Clock
640×480	VGA	60Hz	164.5MHz (Max.)
720×400	VGA TEXT	70Hz	
800×600	VESA	60Hz	
1024×768	VESA	60Hz	
1280×960	VESA	60Hz	
1280×1024	VESA	60Hz	
1600×1200	VESA	60Hz	
1680×1050	VESA CVT	60Hz	
1920×1080	CEA-861	60Hz	
1920×1200*	VESA CVT RB	60Hz	

A graphics board in conformance with VESA standard is required.

\*1 Recommended resolution (Set this resolution).

## Setting Resolution

---

When you connect the monitor to the PC and find that the resolution is improper, or when you want to change the resolution, follow the procedure below.

### ● Windows 7

1. Right-click the mouse anywhere on the desktop except for icons.
2. From the displayed menu, click “Screen resolution”.
3. On the “Screen Resolution” dialog, select the monitor.
4. Click “Resolution” to select the desired resolution.
5. Click the [OK] button.
6. When a confirmation dialog is displayed, click [Keep changes].

### ● Windows Vista

1. Right-click the mouse anywhere on the desktop except for icons.
2. From the displayed menu, click “Personalize”.
3. On the “Personalization” window, click “Display Settings”.
4. On the “Display Settings” dialog, select the “Monitor” tab and select desired resolution in the “Resolution” field.
5. Click the [OK] button.
6. When a confirmation dialog is displayed, click [Yes].

### ● Windows XP

1. Right-click the mouse anywhere on the desktop except for icons.
2. From the displayed menu, click “Properties”.
3. When the “Display Properties” dialog is displayed, click the “Settings” tab and select desired resolution for “Screen resolution” under “Display”.
4. Click the [OK] button to close the dialog.





### ● Mac OS X

1. Select “System Preferences” from the Apple menu.
2. When the “System Preferences” dialog is displayed, click “Displays” for “Hardware”.
3. On the displayed dialog, select the “Display” tab and select desired resolution in the “Resolutions” field.
4. Your selection will be reflected immediately. When you are satisfied with the selected resolution, close the window.

## 2-2. Expanding Signal Output Range [Range Extension]

The signal range can be expanded to meet the input signal from 64/1023 - 1019/1023 to 0/1023 -1023/1023.

### Procedure

1. Choose <Screen> from the Adjustment menu, and press .
2. Choose <Range Extension> from the <Screen> menu, and press .
3. Select “On” with  or .
4. Press  to exit the adjustment.

### Attention

- Settings cannot be performed when CAL mode is being displayed.

## 2-3. Displaying Screen Correctly

### Digital Input

When digital signals are input, images are displayed correctly based on the preset data of the monitor.  
When performing advanced adjustment, see “2-4. Color Adjustment” (page 20) and subsequent pages.

### Analog Input

#### Attention

- Wait 30 minutes or more from monitor power on before starting adjustments.  
(Allow the monitor to warm up for at least 30 minutes before making adjustments.)
- Depending on the condition of the displayed screen, the auto adjustment function may not operate.

The monitor screen adjustment is used to suppress flickering of the screen or adjust screen position and screen size correctly according to the PC to be used.

The Self Adjust function works when all of the following conditions are satisfied.

- When a signal is input into the monitor for the first time or when the resolution or Vertical/Horizontal Frequency not displayed before is set
- When signals with the vertical resolution over 480 are input



If the screen is not displayed correctly even after performing the auto adjustment, perform the screen adjustments according to the procedures on the following pages to use the monitor comfortably.

### [Adjustment Procedure]

#### 1 Perform the auto adjustment.

- To adjust flickering, screen position, and screen size automatically [Auto Adjustment]

#### Procedure

1. Choose <Screen> from the Adjustment menu, and press .
2. Choose <Analog Adjustment> from the <Screen> menu, and press .
3. Choose <Auto Adjustment>, and press .

The auto adjustment function works (the message “In Progress” appears) to correctly adjust the flickering, screen position, and screen size correctly.

When the auto adjustment is completed, a message appears. Select “OK” to confirm the new settings or “Cancel” to restore the previous settings, and press .



---

**Attention**

- This function works correctly when an image is fully displayed over the Windows or Macintosh display area. It does not work properly when an image is displayed only on a part of the screen (command prompt window, for example) or when a black background (wallpaper, etc.) is in use.
  - This function does not work correctly with some graphics boards.
- 

If the screen is not displayed correctly even after adjusting in step 1 above, perform the adjustments according to the procedures on the following pages. When the screen is displayed correctly, go to [step 5](#) “To adjust color gradation automatically [Range Adjustment]”.

## 2 Prepare the display pattern for the analog display adjustment.

### Windows

1. Load the “EIZO LCD Utility Disk” to your PC.
2. Start the “Screen Adjustment Utility” from the startup menu. If it cannot be started, open the screen adjustment pattern files.

---

**Tips**

- For details and instructions on opening the “Screen adjustment pattern files”, refer to the “Readme.txt” file.
- 

### Other than Windows

Download the “Screen adjustment pattern files” from our site: <http://www.eizo.com>

---

**Tips**

- For details and instructions on opening the “Screen adjustment pattern files”, refer to the “Readme.txt” file.
- 

## 3 Perform the auto adjustment again with the analog screen adjustment pattern displayed.

### ● To adjust flickering, screen position, and screen size automatically [Auto Adjustment]

#### Procedure

1. Display Pattern 1 in full screen on the monitor using the “Screen Adjustment Utility” or the screen adjustment patternfiles.



2. Choose <Screen> from the Adjustment menu, and press .
3. Choose <Analog Adjustment> from the <Screen> menu, and press .  
To proceed with the subsequent adjustments, select an item in <Analog Adjustment> of the <Screen> menu.
4. Choose <Auto Adjustment>, and press .  
The auto adjustment function works (the message “In Progress” appears) to adjust the flickering, screen position, and screen size correctly.  
When the auto adjustment is completed, a message appears. Select “OK” to confirm the new settings or “Cancel” to restore the previous settings, and press .

If the screen is not displayed correctly even after adjusting in step 3 above, perform the adjustments according to the procedures on the following pages. When the screen is displayed correctly, go to [step 5](#) “To adjust color gradation automatically [Range Adjustment]”.

## 4 Perform advanced adjustments for the following using the <Screen> menu of the <Analog Adjustment>.

Adjust the clock, phase and position, in this order.

### ● To eliminate vertical bars [Clock]

#### Procedure

1. Choose <Clock> from the <Analog Adjustment> menu, and press ●.
2. Adjust the clock with ▲ or ▼.  
Press ▲▼ slowly so as not to miss the adjustment point.
3. Press ● to exit the adjustment.  
When blurring, flickering or bars appear on the screen after adjustment, proceed to [Phase] to remove flickering or blurring.

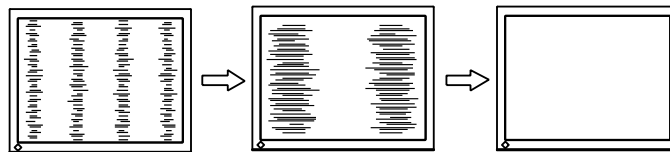

### ● Remove flickering or blurring [Phase]

#### Procedure

1. Choose <Phase> from the <Analog Adjustment> menu, and press ●.
2. Adjust the phase with ▲ or ▼.
3. Press ● to exit the adjustment.

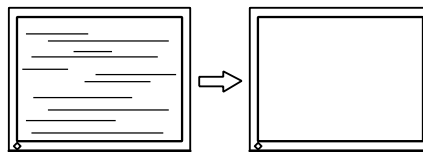

---

#### Attention

- Flickering or blurring may not be eliminated depending on your PC or graphics board.
- 

### ● To correct screen position [Hor.Position] [Ver.Position]

---

#### NOTE

- Since the number of pixels and the pixel positions are fixed on the LCD monitor, only one position is provided to display images correctly. The position adjustment is made to shift an image to the correct position.
- 

#### Procedure

1. Choose <Hor.Position> or <Ver.Position> from the <Analog Adjustment> menu, and press ●.
2. Adjust the position with ▲ or ▼.
3. Press ● to exit the adjustment.

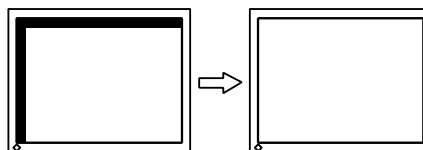

## 5 Adjust the color gradation.

### ● To adjust color gradation automatically [Range Adjustment]

Every color gradation (0 to 255) can be displayed by adjusting the signal output level.

#### **Procedure**

1. Display Pattern 2 in full screen on the monitor using the “Screen Adjustment Utility” or the screen adjustment pattern files.

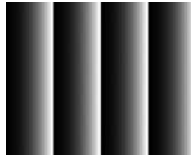

2. Choose <Range> from the <Analog Adjustment> menu, and press .  
The color gradation is adjusted automatically.  
When the auto adjustment is completed, a message appears. Select “OK” to confirm the new settings or “Cancel” to restore the previous settings, and press .
3. Close the Pattern 2. When using the “Screen Adjustment Utility”, close the program.

## 2-4. Color Adjustment

### ● To select the display mode (Color Mode)

Color Mode allows you to select easily the adequate mode suitable for the monitor's application.

#### Color Mode

Mode	Purpose
1-Custom	Available for the color settings according to your preference.
2-Adobe®RGB	Suitable for color matching with Adobe®RGB compatible peripherals.
3-sRGB	Suitable for color matching with sRGB compatible peripherals.
4-EBU	Suitable for reproducing the color gamut and gamma as set forth by EBU (European Broadcasting Union) standards.
5-REC709	Suitable for reproducing the color gamut and gamma as set forth by the ITU-R Rec. 709 standard.
6-SMPTE-C	Suitable for reproducing the color gamut and gamma as set forth by SMPTE-C standards.
7-DCI	Suitable for reproducing the color gamut and gamma as set forth by DCI standards.
8-CAL1 9-CAL2 10-CAL3	Displays the screen adjusted by calibration software.

#### Attention

- “CAL” mode can be adjusted by using the calibration software “ColorNavigator” and SelfCalibration ([page 32](#)).
- With default settings only one CAL mode can be selected for every input signal displayed.
- A CAL mode will be chosen by the ColorNavigator in accordance with the displayed input signal.
- Avoid operating any function of the monitor while using ColorNavigator.

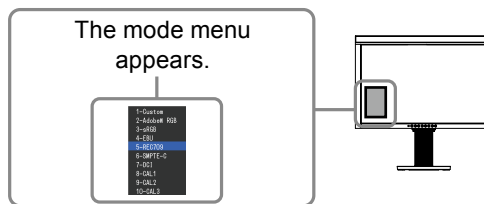

#### Procedure

1. Press **(M)**.  
Mode menu appears at the lower left of the screen.
2. The mode among the list is highlighted in turn each time **(M)** is pressed.  
You can switch the current mode with **(▲)** or **(▼)** while the mode menu is being displayed.

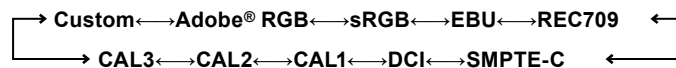

#### NOTE

- The Adjustment menu and the Mode menu cannot be displayed at the same time.
- You can disable a specific mode to be selected. For more information, refer to “3-1. Enabling/Disabling Mode Selection [Mode Preset]” ([page 27](#)).

## ● To perform advanced adjustments

The <Color> menu of the Adjustment menu allows you to set and save the independent color adjustment for each mode.

### Attention

- Wait 30 minutes or more from monitor power on before starting the color adjustment.  
(Allow the monitor to warm up for at least 30 minutes before making adjustments.)
- Perform the range adjustment first when adjusting color for analog input signals.  
(Refer to “To adjust color gradation automatically” on [page 19](#)).
- The same image may be seen in different colors on multiple monitors due to their monitor-specific characteristics.  
Make fine color adjustment visually when matching colors on multiple monitors.

### NOTE

- The values shown in “%” or “K” are available only as reference.

## ● Adjustment items in each mode

According to the mode selected, the adjustable function differs.

(You can not select any function unavailable for adjustment or setting.)

The adjustments or settings made for each mode are applied to all input signals.

For the adjustment method of each function, refer to subsequent pages.

√: Adjustment available —: Invalid for adjustment





Icon	Function	Color Mode							8-CAL1 9-CAL2 10-CAL3
		1-Custom	2-Adobe @RGB	3-sRGB	4-EBU	5-REC709	6-SMPTE-C	7-DCI	
	Brightness	√	√	√	√	√	√	√	—
	Contrast	√	—	—	—	—	—	—	—
	Temperature	√	√	√	√	√	√	√	—
	Gamma	√	√	√	√	√	√	√	—
	Hue	√	—	—	—	—	—	—	—
	Saturation	√	—	—	—	—	—	—	—
	Outline Enhancer	√	√	√	√	√	√	√	—
	Gain	√	—	—	—	—	—	—	—
	Black Level	√	√	√	√	√	√	√	—
	6 Colors	√	—	—	—	—	—	—	—
	Color Reset	√	√	√	√	√	√	√	—

## ● To adjust the brightness [Brightness]

The screen brightness is adjusted by changing the brightness of the backlight (Light source from the LCD back panel).



Adjustable range: 0 to 100%

### Procedure

1. Choose <Color> from the Adjustment menu, and press .
2. Choose <Brightness> from the <Color> menu, and press .
3. Adjust the brightness with  or .
4. Press  to exit the adjustment.

---

#### NOTE





- You can also adjust the brightness using  and .
  - When you feel the image is bright even if the brightness is set to 0%, adjust the contrast.
- 

## ● To adjust the contrast [Contrast]

The luminance of the screen is adjusted by varying the video signal level.

Adjustable range: 0 to 100%

### Procedure

1. Choose <Color> from the Adjustment menu, and press .
2. Choose <Contrast> from the <Color> menu, and press .
3. Adjust the contrast with  or .
4. Press  to exit the adjustment.

---

#### NOTE





- In the contrast of 100%, every color gradation is displayed.
  - When adjusting the monitor, it is recommended to perform the brightness adjustment which may not lose the gradation characteristics, prior to the contrast adjustment.
  - Perform the contrast adjustment in the following cases.
    - When you feel the image is bright even if the brightness is set to 0%. (Set the contrast to lower than 100%).
- 

## ● To adjust the color temperature [Temperature]

The color temperature can be adjusted. The color temperature is normally used to express the hue of “White” and/or “Black” by a numerical value. The value is expressed in degrees “K” (Kelvin). In the same way as the flame temperature, the image on the monitor is displayed reddish if the color temperature is low and is bluish if the color temperature is high. The gain preset values are set for each color temperature setting value.

Adjustable range: Native, 4000K-10000K (100K unit)

### Procedure

1. Choose <Color> from the Adjustment menu, and press .
2. Choose <Temperature> from the <Color> menu, and press .
3. Adjust the color temperature with  or .
4. Press  to exit the adjustment.

---

#### NOTE





- [Gain] allows you to perform more advanced adjustment (See “To adjust the gain value” on [page 24](#)).
  - If you set to [Native], the image is displayed in the preset color of the monitor (Gain: 100% for each RGB).
  - When changing the gain value, the color temperature adjusting range is changed to “User”.
  - The default setting for each Adobe®RGB/sRGB/EBU/REC709/SMPTE-C/DCI mode is set to “Standard”, which is the temperature in conformity with each standard.
-

## ● To adjust the gamma value [Gamma]

The gamma value can be adjusted. The luminance of the monitor varies depending on the input signal, however, the variation rate is not proportional to the input signal. To keep the balance between the input signal and the luminance of the monitor is called as “Gamma correction”.

Adjustable range: 1.6-2.7 (0.1 unit)

### **Procedure**

1. Choose <Color> from the Adjustment menu, and press .
2. Choose <Gamma> from the <Color> menu, and press .
3. Adjust the gamma value with  or .
4. Press  to exit the adjustment.

---

### **NOTE**







- The default setting for each Adobe®RGB/sRGB/EBU/REC709/SMPTE-C/DCI mode is set to “Standard”, which is the gamma in conformity with each standard.
- 

## ● To adjust the hue [Hue]

This function allows you to adjust the hue.

Adjustable range: -100 to 100

### **Procedure**

1. Choose <Color> from the Adjustment menu, and press .
2. Choose <Advanced Settings> from the <Color> menu, and press .
3. Choose <Hue>, and press .
4. Adjust the hue with  or .
5. Press  to exit the adjustment.

---

### **Attention**







- This function does not enable to display every color gradation.
- 

## ● To adjust the color saturation [Saturation]

This function allows you to adjust the saturation of the color on the monitor.

Adjustable range: -100 to 100

### **Procedure**

1. Choose <Color> from the Adjustment menu, and press .
2. Choose <Advanced Settings> from the <Color> menu, and press .
3. Choose <Saturation>, and press .
4. Adjust the saturation of the color with  or .
5. Press  to exit the adjustment.

---

### **Attention**

- This function does not enable to display every color gradation.
- 

---

### **NOTE**







- Setting the minimum (-100) turns the image to a monochrome screen.
-

## ● To enhance the outline of the image [Outline Enhancer]

OutlineEnhancer functions to emphasize outline of the images by emphasizing the color difference between pixels composing the images. This may improve the texture of the material and its feel of the images.

On the contrary, it also functions to reproduce the images smoothly by gradating its outline.

### **Procedure**







1. Choose <Color> from the Adjustment menu, and press .
2. Choose <Advanced Settings> from the <Color> menu, and press .
3. Choose <Outline Enhancer> and press .
4. Select the display status in the range from -3 to 3 (soft to sharp) with  or  as desired.
5. Press  to exit the adjustment.

## ● To adjust the gain value [Gain]

Each luminance of red/green/blue composing the color is called “Gain”. The gain adjustment may change the color tone of the “White” (when the max input signal for each color is obtained)

Adjustable range: 0 to 100%

### **Procedure**

1. Choose <Color> from the Adjustment menu, and press .
2. Choose <Advanced Settings> from the <Color> menu, and press .
3. Choose <Gain>, and press .
4. Choose the color for adjustment among <Red>, <Green>, or <Blue> to adjust, and press .
5. Adjust the gain with  or .
6. Press  to exit the adjustment.

---

### **NOTE**







- The <Temperature> setting invalidates this setting.
  - The gain value may change depending on the value of the color temperature.
  - When changing the gain value, the color temperature adjusting range is changed to “User”.
- 

## ● To adjust the black level [Black Level]

The brightness of black and chromaticity can be adjusted based on the respective black level of red, green and blue. Adjust the black level by showing images with black background.

Adjustable range: 0 to 100%

### **Procedure**

1. Choose <Color> from the Adjustment menu, and press .
2. Choose <Advanced Settings> from the <Color> menu, and press .
3. Choose <Black Level>, and press .
4. Choose the color for adjustment among <Red>, <Green>, or <Blue> to adjust, and press .
5. Adjust the black level with  or .
6. Press  to exit the adjustment.

---

### **Tips**

- To further darken the black when the value of the black level is 0, lower the brightness value.
  - Lowering the contrast value will not change the brightness of the black level.
-











## ● To adjust six colors [6 Colors]

The hue and saturation can be adjusted for each of six colors: Magenta, Red, Yellow, Green, Cyan, and Blue.

Adjustable range: -100 to 100

### **Procedure**

1. Choose <Color> from the Adjustment menu, and press .
2. Choose <Advanced Settings> from the <Color> menu, and press .
3. Choose <6 Colors>, and press .
4. Choose the color for adjustment among <Magenta>, <Red>, <Yellow>, <Green>, <Cyan>, or <Blue>, and press .
5. Select <Hue> or <Saturation>, and press .
6. Adjust the 6 colors with  or .
7. Press  to exit the adjustment.

## 2-5. Displaying Lower Resolutions

### ● To change screen size [Screen Size]

The image with the resolution other than the recommended resolution is displayed in full screen automatically. You can change the screen size by using <Screen Size> from <Screen> menu.

Menu	Function
Full (default setting)	Displays an image in full screen. Images are distorted in some cases because the vertical rate is not equal to the horizontal rate.
Enlarged	Displays an image in full screen. In some cases, a blank horizontal or vertical border appears to equalize the vertical rate and the horizontal rate.
Normal	Displays images with the specified resolution.

Example: Image size 1280 x 1024

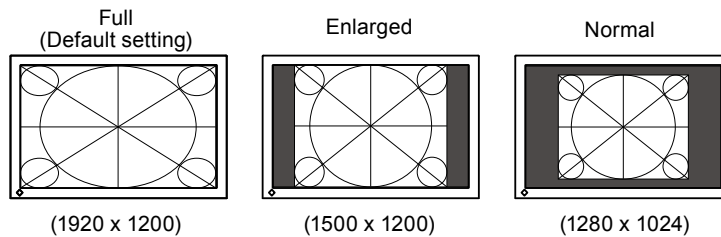

### Procedure

1. Choose <Screen> from the Adjustment menu, and press .
2. Choose <Screen Size> from the <Screen> menu, and press .
3. Select “Full Screen,” “Enlarged,” or “Normal” with  or .
4. Press  to exit the adjustment.

## 2-6. Configuring moving image performance [Overdrive]

By using the <Overdrive> setting, the extent to which fast moving images produce visible afterimages can be reduced. This setting is set to “On” by default, but while turned “On” noise and afterimages may instead be more noticeable. In such a case, please set the <Overdrive> setting to “Off”.

### Procedure

1. Choose <Tools> from the Adjustment menu, and press .
2. Choose <Overdrive> from the <Tools> menu, and press .
3. Select “On” or “Off” with  or .
4. Press  to exit the adjustment.









# Chapter 3 Setting Monitor

## 3-1. Enabling/Disabling Mode Selection [Mode Preset].....

Allows you to select the specified modes only.

Use this function when all the display modes are not available or when keeping the display mode unchanged.

### Procedure

1. Choose <Tools> from the Adjustment menu, and press .
2. Choose <Mode Preset> from the <Tools> menu, and press .
3. Select the mode to change its settings with  or , and press .
4. Select “On” or “Off” with  or .
5. Press  to exit the adjustment.







### Attention



- You cannot set all the modes disable. Set at least one mode to “On”.



## 3-2. Locking Buttons [Key Lock].....

This function allows you to lock to prevent changing the adjusted/set status.

### Procedure

1. Press  to turn off the monitor.
2. Press  holding  down for at least 2 seconds to turn on the monitor.  
The Optional Settings menu appears.
3. Choose <Key Lock> from the <Optional Settings> menu, and press .
4. Select “Off”, “Menu”, or “All” with  or , and press .

Settings	Buttons that can be locked
Off (Initial settings)	None (All buttons are enabled)
Menu	 button
All	All buttons excluding 

5. Select “Finish” with  or .
6. Press  to exit.  
The Optional Settings menu is closed.

### 3-3. Setting the EIZO Logo Display [Logo]

The EIZO logo appears on the display when turning on the monitor. This function allows you to display, or not, the EIZO logo.

#### Procedure

1. Press  $\text{\textcircled{P}}$  to turn off the monitor.
2. Press  $\text{\textcircled{M}}$  holding  $\text{\textcircled{P}}$  down at least 2 seconds to turn on the monitor.  
The Optional Settings menu appears.
3. Choose <Logo> from the <Optional Settings> menu, and press  $\text{\textcircled{O}}$ .
4. Select “On” or “Off” with  $\text{\textcircled{\blacktriangle}}$  or  $\text{\textcircled{\blacktriangledown}}$ , and press  $\text{\textcircled{O}}$ .
5. Select “Finish” with  $\text{\textcircled{\blacktriangle}}$  or  $\text{\textcircled{\blacktriangledown}}$ .
6. Press  $\text{\textcircled{O}}$  to exit the Optional Settings.

The Optional Settings menu is closed.

### 3-4. Setting Orientation [Orientation]

This function allows you to change the orientation of the Adjustment menu when using the monitor screen in vertical display position. (Default settings : Landscape)

#### Procedure

1. Choose <Menu Settings> from the Adjustment menu, and press  $\text{\textcircled{O}}$ .
2. Choose <Orientation> from the <Menu Settings> menu, and press  $\text{\textcircled{O}}$ .
3. Select “Landscape” or “Portrait” with  $\text{\textcircled{\blacktriangle}}$  or  $\text{\textcircled{\blacktriangledown}}$ .
4. Press  $\text{\textcircled{O}}$  to exit the adjustment.
5. When selecting “Portrait”, turn the monitor screen 90° in clockwise direction.

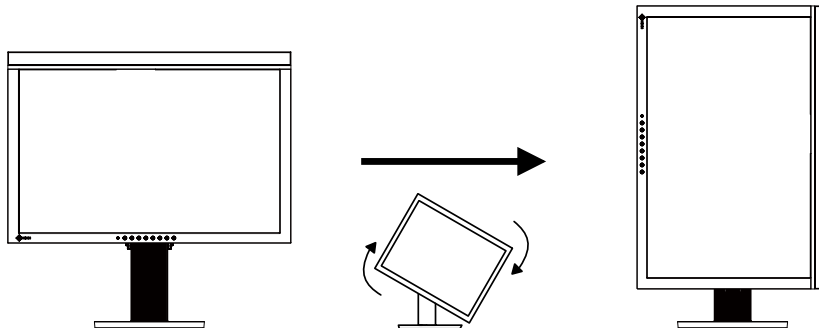

#### Attention

- Be sure that the cables are correctly connected.

#### Tips

- For using the monitor with “Portrait” position, the graphics board supporting portrait display is required. When placing the monitor in a “Portrait” position, settings of your graphics board need to be changed. Refer to the manual of the graphics board for details.





## 3-5. Setting Language [Language]

This function allows you to select a language for the adjustment menu or displaying message.

### Selectable languages

English/German/French/Spanish/Italian/Swedish/Japanese /Simplified Chinese/Traditional Chinese

#### Procedure

1. Choose <Menu Settings> menu from the Adjustment menu, and press .
2. Choose <Language> from the <Menu Settings> menu, and press .
3. Choose a language with  or .
4. Press  to exit the adjustment.









## 3-6. Setting Range of Frequency [Signal Bandwidth]

Depending upon your operating environment, it may be necessary to set the frequency that corresponds to your graphics board. If you install it for the first time or change environment, set the monitor.

#### NOTE





- Refer to the manual of the graphics board.
- These environment described below can be set regardless of whether or not the computer is running.
- Only digital input signals can be set up.

#### Procedure

1. Press  to turn off the monitor.
  2. Press  holding down  at least 2 seconds to turn on the monitor.  
The Optional Settings menu appears.
  3. Choose <Signal Bandwidth> from the <Optional Settings> menu, and press .
  4. Select “Normal” or “Wide” with  or , and press .
- Use  or  to select (or just confirm) the frequency that corresponds to your graphics board.

Setting	Horizontal scanning frequency (kHz)	Vertical scanning frequency (Hz)
Normal	26~78	59~61
Wide -1	26~78	23.75~63
Wide -2/-3 *1	Used when inputting a special signal.	

\*1: Wide-2/3 cannot be selected when using DisplayPort.





5. Press .
  6. Select “Finish” with  or .
  7. Press .
- The Optional Settings menu is closed.

## 3-7. Setting the Display Position of the Adjustment Menu [Menu Position]

---

Adjust the menu position using the following procedure.

### **Procedure**





1. Choose <Menu Settings> from the Adjustment menu, and press .
2. Choose <Menu Position> from the <Menu Settings> menu, and press .
3. Select a menu position with  or .
4. Press  to exit the adjustment.

## 3-8. Sets the brightness of the front buttons [Indicator]

---

The brightness of the power button (blue) and operation keys (white) when the screen is displayed can be set. (The power button and operation keys are set to light up when the power is switched on, and are set to 4 by default.)

### **Procedure**

1. Choose <PowerManager> from the Adjustment menu, and press .
2. Choose <Power Indicator> from the <PowerManager> menu, and press .
3. Select the brightness of the button to “Off” or in the range from 1 to 7 with  or  as desired.
4. Press  to exit the adjustment.

## 3-9. Restoring the Default Setting

There are two types of Reset. One is to reset the color adjustment only to the default settings, and the other is to reset all the settings to the default settings.

---

**Attention**

- After resetting, you cannot undo the operation.
- 

---





**NOTE**

- For main default settings, refer to “Main default settings (factory settings)” on [page 46](#).
- 

### ● To reset color adjustment values [Color Reset]

Only the adjustment values in the current mode will revert to the default settings (factory settings).

**Procedure**





1. Choose <Color> from the Adjustment menu, and press .
2. Choose <Color Reset> from the <Color> menu and press .
3. Select “Execute” with  or .
4. Press .

The color adjustment values revert to the default settings.

### ● To reset all adjustments to the factory default settings [All Reset]

Reset all adjustments to the factory default settings.

**Procedure**

1. Choose <Tools> from the Adjustment menu, and press .
2. Choose <All Reset> from the <Tools> menu, and press .
3. Select “Execute” with  or .
4. Press .

All setting values revert to the default settings.

---

**NOTE**

- The settings done through the clock settings and the optional settings menu in the SelfCalibration menu are not returned to the default.
-

# Chapter 4 SelfCalibration

This product is equipped with a built-in calibration sensor. This function allows you to set the calibration targets or schedule in advance, and automatically execute regular calibration. Calibration can be executed independently by the monitor.

---

**Attention**

- To execute SelfCalibration, it is necessary to set the calibration targets etc.
  - For more information, refer to “4-3. Setting Calibration Details [Setting]” (page 33).
- 

**NOTE**

- Use SelfCalibration as support for monitor calibration with ColorNavigator.
  - When matching the measurement results of the built-in sensor with the measurement results from a measurement device, use the Correlation Utility included with ColorNavigator. Refer to the ColorNavigator User's Manual on the CD-ROM.
  - SelfCalibration can also be executed when there are no computer signals being input.
- 

## 4-1. Executing SelfCalibration [Calibration]

**Procedure**

1. Press **C**.  
The SelfCalibration menu appears.
2. Choose <Calibration> from the SelfCalibration menu, and press **●**.
3. Select “Execute” with **▲** or **▼**.
4. Press **●**.  
The built-in sensor is activated, and SelfCalibration is executed.

---

**Attention**

- To execute SelfCalibration, it is necessary to select CAL mode.
  - After selecting execute, aging may be executed before the built-in sensor is activated.
- 

## 4-2. Checking Calibration Results [Result]

The previous calibration results can be checked.

**Procedure**

1. Choose <Result> from the SelfCalibration menu, and press **●**.
2. Select the mode you want to check the results for with **▲** or **▼**.  
The Result menu appears.  
The date and time the last SelfCalibration was executed, and the total monitor usage time from the previous calibration are displayed.
3. Select “Calibration Result” or “Ambient Light” with **▲** or **▼**.  
The previous calibration results are displayed.

---

**Attention**

- The measurement results of the ambient light sensor are used to check the difference between the current environmental light level and the level of ambient light when calibration was executed, and are not reflected in the calibration results.
- 

**NOTE**

- If <Ambient Light> is selected, the current environmental light is also displayed.
  - Numerical values that do not reach the target values are displayed in yellow.
  - If the environment in which the product is used is significantly different to the previous environment, the ambient light measurement results may differ greatly between the previous calibrations and current calibrations.
-











## 4-3. Setting Calibration Details [Setting]

### ● Setting the mode to execute SelfCalibration [Mode Selection]

Set the mode to execute SelfCalibration.

#### Procedure

1. Choose <Setting> from the SelfCalibration menu, and press .
2. Choose <Mode Selection> from the Setting menu, and press .
3. Select the mode to change with  or , and press .
4. Select "On" or "Off" with  or .
5. Press  to exit the adjustment.









#### NOTE

- When "CAL1/CAL2/CAL3" is set to "On", SelfCalibration can be executed.
- When "Other Modes" is set to "On", the monitor color reproduction area is updated and the display in each color mode will be adjusted as follows:
  - In any mode other than CAL mode, the temperature is adjusted so that it is as close as possible to the specified value.
  - In Adobe RGB/sRGB/EBU/REC709/SMPTE-C/DCI modes, the gamut values are adjusted so that they are close to each specified value.

### ● Setting the calibration targets

Set the calibration targets for SelfCalibration.

#### Procedure



1. Choose <Setting> from the SelfCalibration menu, and press .
2. Choose <Target> from the Setting menu, and press .
3. Select the items to change with  or , and press .  
The target setting menu is displayed.
4. Select the items to change with  or , and press .

Setting Item	Setting Range	Setting
Brightness	30 - 250 cd/m2	Set the brightness of the monitor using the brightness value (cd/m2).
White Point	Color : 0.2400 - 0.4500 *1 Temperature : 4000 - 10000K (100K Unit)*2	Set the monitor White Point using the color coordinate or Temperature.
Color Gamut	Native/User	Set whether to calibrate color gamut. Native : Color gamut calibration is not performed. User : Color gamut calibration is performed.
	0.0000 - 1.0000 (For each of Red/Green/Blue)	To calibrate the monitor color reproduction gamut, set the color coordinates for red, green, and blue.
Gamma	1.6 - 2.7 (0.1 Unit)*3	Set the monitor gamma values.

\*1 When the color coordinates are set, the temperature changes to [User].

\*2 When the temperature is set, the x and y coordinates of the white point are set automatically.

\*3 These become [Fixed] when calibrating with ColorNavigator.

5. Adjust using  or .
6. Press  to exit the adjustment.  
The calibration targets are set.

#### Attention

- Only set the color gamut calibration when the target color range is precisely known.
- If ColorNavigator was used to calibrate the grey balance, do not change the gamma setting values.

#### NOTE

- The calibration targets set using ColorNavigator are set as the calibration targets for the monitor.

## ● Setting the monitor date and time [Clock Adjustment]









Set the monitor date and time.

---

**NOTE**

- When ColorNavigator is started, the date and time are automatically set. Refer to the ColorNavigator User's Manual on the CD-ROM.
- 

### **Procedure**

1. Choose <Setting> from the SelfCalibration menu, and press .
  2. Choose <Clock Adjustment> from the Setting menu, and press .  
The Clock Adjustment menu appears.
  3. Select the date using  or , and then press .
  4. Select the time using  or , and then press .
- The date and time for the monitor are set.

---

**Attention**

- If the main power supply is disconnected for an extended period of time, the clock may need resetting.
-





## ● Setting the calibration schedule [Schedule]

Set the calibration schedule for SelfCalibration.

### Attention



- Clock adjustment is necessary for SelfCalibration to operate.

### Procedure

1. Choose <Setting> from the SelfCalibration menu, and press .
2. Choose <Schedule> from the Setting menu, and press .  
The schedule setting menu is displayed.
3. Select the items to change with  or , and press .

Setting Item	Setting Range	Setting
Starting Time	Off Power Save Immediately	Set the timing at which SelfCalibration is executed. Off : SelfCalibration is not executed. Power Save : When the time period set in the schedule has elapsed, it is executed if the mode initially switches to power save, or if the power initially switches off. Immediately : When the time period set in the schedule has elapsed, it is executed immediately.
Setting Type	Type1 Type2 Type3	Set according to the frequency at which SelfCalibration is executed. Type1 : Once every few months Type2 : Once every few weeks Type3 : Once every few hours (monitor usage time)
Interval	Type1 : 1 - 12 months Type2 : 1 - 5 weeks Type3 : 50 - 500 h	Set the interval between the completed SelfCalibration and the next execution. The setting details differ depending on the type of <Setting Type> specified.
Week	1st week - 5th week	Set which week to execute SelfCalibration on for the month in which calibration is executed.
Day	MON/TUE/WED/THU/ FRI/SAT/SUN	Set which day to execute SelfCalibration on for the week in which calibration is executed.
Time	00:00 - 23:30	Set the time at which SelfCalibration is executed.

\*1 Settings that are used frequently can be preset.

4. Adjust using  or .
5. Press  to exit the adjustment.  
The calibration schedule is set.

### NOTE

- The schedule can be set using ColorNavigator. Refer to the ColorNavigator User's Manual on the CD-ROM.
- When the starting time is [Immediately], and the setting type is either [Type1] or [Type2], SelfCalibration is executed according to schedule even if the power is switched off using .
- When the starting time is "Off", the SelfCalibration menu shows "Setting Incomplete." However, SelfCalibration can be executed manually.

# Chapter 5 Power Saving Function

## 5-1. Setting the Power Saving [Power Save]

This function allows you to set the monitor into the power saving mode according to the PC status. When the monitor enters the power saving mode, no image is displayed on the screen.





### Attention

- Either switch off the main power supply or remove the power plug from the socket to completely stop the supply of electricity to the monitor.
- Devices connected to the USB port (upstream and downstream) work when the monitor is in power saving mode or when the power button of the monitor is Off. Therefore, power consumption of the monitor varies with connected devices even in the power saving mode.

Power Save is compliant with the following standards for the respective signal inputs.

signal inputs		Standard
Analog signal		VESA DPMS
Digital signal	DVI	DVI DMPM
	DisplayPort	DisplayPort Standard V1.1a

### Procedure

1. Choose <PowerManager> from the Adjustment menu, and press .
2. Choose <Power Save> from the <PowerManager> menu, and press .
3. Select "On" or "Off" with  or .
4. Press  to exit the adjustment.

### Power Saving System





The monitor enters the power saving mode in conjunction with the PC settings.



PC		Monitor Power	Indicator
Operating		Operating	Blue
Power saving	STAND-BY SUSPENDED OFF	Power saving	Orange

# Chapter 6 Troubleshooting

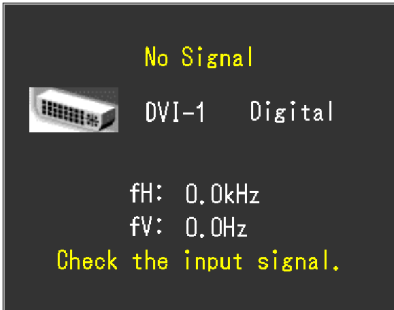
If a problem still remains after applying the suggested remedies, contact your local dealer.

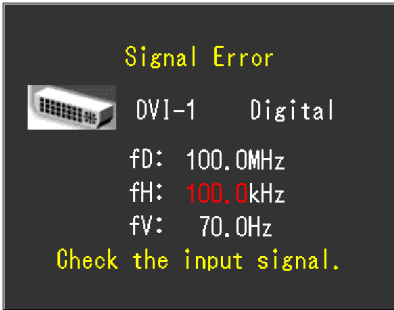
- No-picture problems → See No.1 - No.2.
- Imaging problems (digital input) → See No.3 - No.8.
- Imaging problems (analog input) → See No.3 - No.12.
- Other problems → See No.13 - No.16.

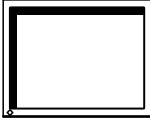
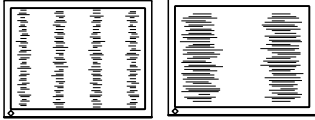
Problems	Possible cause and remedy
<b>1. No picture</b> <ul style="list-style-type: none"> <li>• Power indicator does not light.</li> </ul>	<ul style="list-style-type: none"> <li>• Check whether the power cord is connected correctly.</li> <li>• Turn off the main power, and then turn it on again a few minutes later.</li> <li>• Turn the main power switch on.</li> <li>• Press .</li> </ul>
<ul style="list-style-type: none"> <li>• Power indicator lights blue.</li> </ul>	<ul style="list-style-type: none"> <li>• Set each adjusting value in [Brightness], [Contrast] and [Gain] to higher level. (page 22, page 24)</li> </ul>
<ul style="list-style-type: none"> <li>• Power indicator lights orange.</li> </ul>	<ul style="list-style-type: none"> <li>• Switch the input signal with .</li> <li>• Operate the mouse or keyboard.</li> <li>• Check whether the PC is turned on.</li> </ul>
<b>2. The message below appears.</b> <ul style="list-style-type: none"> <li>• This message appears when no signal is input. Example:</li> </ul> 	<p>This message appears when the signal is not input correctly even when the monitor functions properly.</p> <ul style="list-style-type: none"> <li>• The message shown left may appear, because some PCs do not output the signal soon after power-on.</li> <li>• Check whether the PC is turned on.</li> <li>• Check whether the signal cable is connected properly.</li> <li>• Switch the input signal with .</li> </ul>
<ul style="list-style-type: none"> <li>• The message shows that the input signal is out of the specified frequency range. (Such signal frequency is displayed in red.) Example:</li> </ul> 	<ul style="list-style-type: none"> <li>• Check whether the signal setting of your PC matches the resolution and the vertical frequency settings for the monitor. (refer to the Setup Manual "Setting Screen Resolution")</li> <li>• Reboot the PC.</li> <li>• Select an appropriate display mode using the graphics board's utility. Refer to the manual of the graphics board for details. <ul style="list-style-type: none"> <li>fD : Dot Clock (Displayed only when the digital signal inputs)</li> <li>fH : Horizontal Frequency</li> <li>fV : Vertical Frequency</li> </ul> </li> </ul>
<b>3. The screen is too bright or too dark.</b>	<ul style="list-style-type: none"> <li>• Adjust using [Brightness] or [Contrast]. (The LCD monitor backlight has a fixed life span. When the screen becomes dark or begins to flicker, contact your local dealer.)</li> </ul>

Problems	Possible cause and remedy
<b>4. Characters are blurred</b>	<ul style="list-style-type: none"> <li>• Check whether the signal setting of your PC matches the resolution and the vertical frequency settings for the monitor.</li> <li>• Adjust using &lt;Outline Enhancer&gt;. (page 24)</li> </ul>
<b>5. Afterimages appear</b>	<ul style="list-style-type: none"> <li>• Afterimages are particular to LCD monitors. Avoid displaying the same image for a long time.</li> <li>• Use the screen saver or power save function to avoid displaying the same image for extended periods of time.</li> </ul>
<b>6. Green/red/blue/white dots or defective dots remain on the screen.</b>	<ul style="list-style-type: none"> <li>• This is due to LCD panel characteristics and is not a failure.</li> </ul>
<b>7. Interference patterns or pressure marks remain on the screen.</b>	<ul style="list-style-type: none"> <li>• Leave the monitor with a white or black screen. The symptom may disappear.</li> </ul>
<b>8. Noise appears on the screen.</b>	<ul style="list-style-type: none"> <li>• When entering the signals of HDCP system, the normal images may not be displayed immediately.</li> </ul>
<b>9. Display position is incorrect.</b> 	<ul style="list-style-type: none"> <li>• Adjust image position using &lt;Hor.Position&gt; or &lt;Ver.Position&gt;. (page 18)</li> <li>• If the problem persists, use the graphics board's utility if available to change the display position.</li> </ul>
<b>10. Vertical bars appear on the screen or a part of the image is flickering.</b> 	<ul style="list-style-type: none"> <li>• Adjust using &lt;Clock&gt;. (page 18)</li> </ul>
<b>11. Whole screen is flickering or blurring.</b> 	<ul style="list-style-type: none"> <li>• Adjust using &lt;Phase&gt;. (page 18)</li> </ul>
<b>12. Upper part of the screen is distorted as shown below.</b> 	<ul style="list-style-type: none"> <li>• This is caused when both composite sync (X-OR) signal and separate vertical sync signal are input simultaneously. Select either composite signal or separate signal.</li> </ul>
<b>13. The adjustment menu does not appear.</b>	<ul style="list-style-type: none"> <li>• Check whether the operation lock function works. (page 27)</li> </ul>
<b>14. Mode menu does not appear.</b>	<ul style="list-style-type: none"> <li>• Check whether the operation lock function works. (page 27)</li> </ul>
<b>15. The auto adjust function does not work correctly.</b>	<ul style="list-style-type: none"> <li>• This function does not work when digital signal is input.</li> <li>• This function is intended for use on the Macintosh and on AT-compatible PC running Windows. It may not work properly in either of the following cases. It does not work properly when an image is displayed only on a part of the screen (command prompt window, for example) or when a black background (wallpaper, etc.) is in use.</li> <li>• This function does not work correctly with some graphics boards.</li> </ul>

Problems	Possible cause and remedy
16. The monitor connected with the USB cable is not detected. / USB devices connected to the monitor does not work.	<ul style="list-style-type: none"> <li>• Check whether the USB cable is connected correctly. (page 43)</li> <li>• Change the USB port to another one. If the PC or peripheral devices works correctly by changing the USB port, contact your local dealer. (Refer to the manual of the PC for details.)</li> <li>• Reboot the PC.</li> <li>• If the peripheral devices work correctly when the PC and peripheral devices are connected directly, please contact your local dealer.</li> <li>• Check whether the PC and OS are USB compliant. (For USB compliance of the respective devices, consult their manufacturers.)</li> <li>• Check the PC's BIOS setting for USB when using Windows. (Refer to the manual of the PC for details.)</li> </ul>

#### Errors involving the built-in sensor and SelfCalibration

Problems	Possible cause and remedy
1. The built-in sensor comes out automatically when the main power switch is switched on.	<ul style="list-style-type: none"> <li>• This is not a malfunction. The built-in sensor comes out automatically when the power is switched on to check the operation of the built-in sensor.</li> </ul>
2. The built-in sensor does not come out/ stays out.	<ul style="list-style-type: none"> <li>• Turn off the main power, and then turn it on again a few minutes later.</li> <li>• If a problem still remains after applying the suggested remedies, contact your local dealer.</li> </ul>
3. Cannot execute SelfCalibration	<ul style="list-style-type: none"> <li>• Check whether the time is set correctly.</li> <li>• Check whether the mode is set.</li> <li>• Check whether the calibration targets are set correctly.</li> </ul>
4. SelfCalibration failure Example:	<ul style="list-style-type: none"> <li>• SelfCalibration failed for some reason.</li> <li>• Refer to the SelfCalibration error code table.</li> <li>• If an error code that does not appear in the SelfCalibration error code table is displayed, contact your local dealer.</li> </ul>

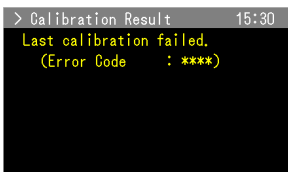

#### SelfCalibration Error Code Table

Error Code	Possible cause and remedy
in the 100s	• Indicates errors that occurred during CAL1 SelfCalibration.
in the 200s	• Indicates errors that occurred during CAL2 SelfCalibration.
in the 300s	• Indicates errors that occurred during CAL3 SelfCalibration.
in the 900s	• Displays errors that occurred during SelfCalibration in other modes.
0*10	• The product maximum brightness may be lower than the target brightness. Lower the target brightness.
0*34	• The built-in sensor may not have come out during calibration, or light may have entered the sensor during measurement. Turn off the main power, wait for a few minutes before turning the power back on, and then execute SelfCalibration again.
0*50	• Light may have entered the built-in sensor while the sensor was initializing. Execute SelfCalibration again.
0*90	• Modes in which SelfCalibration cannot be executed are displayed. Execute SelfCalibration after displaying the CAL mode in which the targets are set.
0*91	• SelfCalibration was cancelled. Execute SelfCalibration again.

# Chapter 7 Reference

## 7-1. Attaching an Arm

The stand can be removed and replaced with an arm (or another stand) to be attached to the monitor. Use an arm or stand of EIZO option.

### Attention

- When attaching an arm or stand, follow the instructions of their user's manual.
- When using another manufacturer's arm or stand, confirm the following in advance and select one conforming to the VESA standard.
  - Clearance between the screw holes: 100 mm × 100 mm
  - Thickness of plate: 2.6 mm
  - Strong enough to support weight of the monitor unit (except the stand) and attachments such as cables.
- Use the screws as described below.
  - The screws fixing the stand to the monitor
- When using an arm or stand, attach it to meet the following tilt angles of the monitor.
  - Up 45 degrees, down 45 degrees (horizontal display, and vertical display rotated 90 degrees clockwise)
- Connect the cables after attaching an arm or a stand.
- Do not adjust the height of the stand removed from the monitor. When adjusted without attached monitor, it causes the personnel injury or the damaged to the stand.
- Since the monitor and arm are so heavy, dropping them may result in injury or equipment damage.

### [Attachment Procedure]

**1 Lay the LCD monitor on a soft cloth spread over on a stable surface with the panel surface facing down.**

**2 Remove the stand.**

Prepare a screwdriver. Unscrew the four screws securing the unit and the stand with the screwdriver.

**3 Attach the monitor to the arm or stand.**

Use the screws that hold the monitor and stand together for installation.

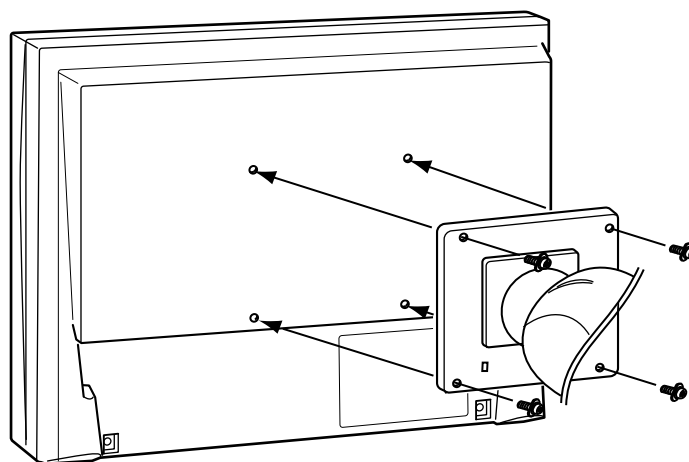



## 7-2. Connecting More than Two PCs to the Monitor

More than two PCs can be connected to the monitor through the DVI-I and the DisplayPort connector on the back of the monitor.

### Connection examples

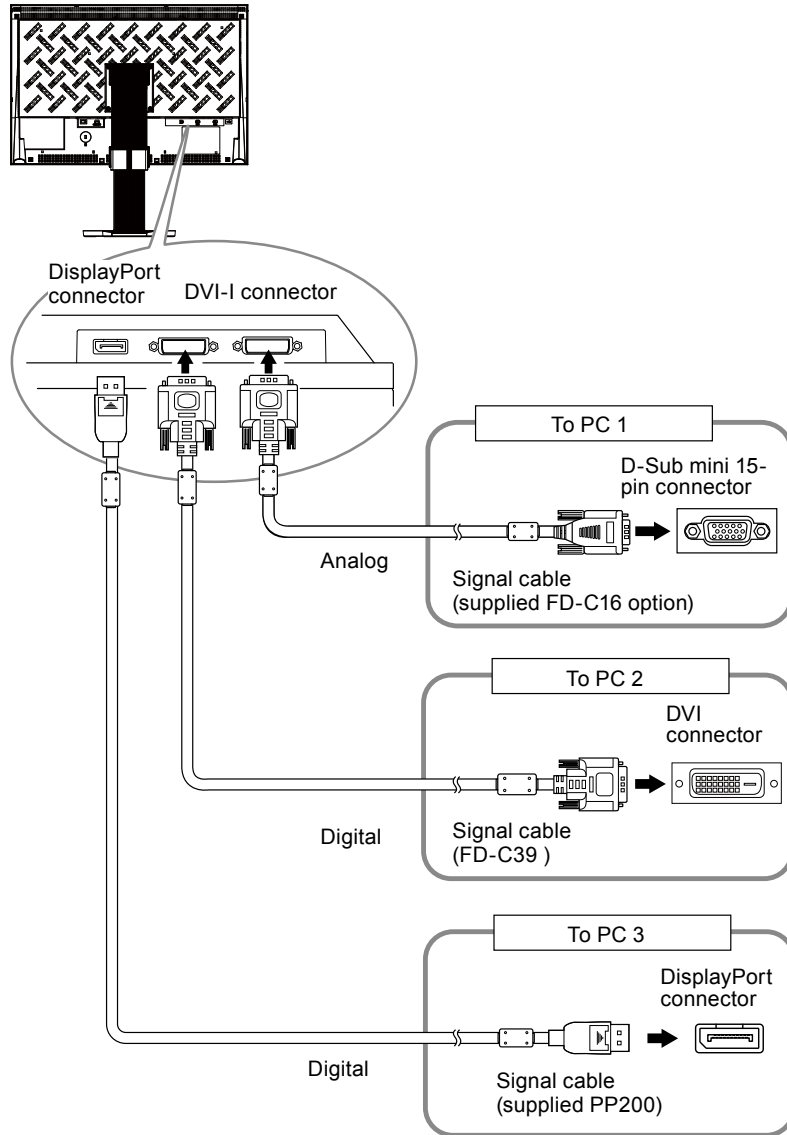

### ● To switch the input signal

The input signal switches each time **(S)** is pressed.

When the signal is switched, the active input port name appears at the top right corner of the screen.

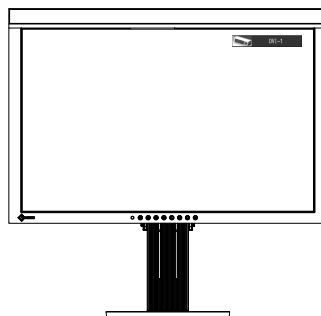

● To set input signal selection [Input Selection]

Setting	Function
Auto	The monitor recognizes the connector through which PC signals are input. When a PC is turned off or enters the powersaving mode, the monitor automatically displays another signal.
Manual	The monitor detects only the PC's signals currently displaying automatically. Select an active input signal with <b>(S)</b> .

**Procedure**

1. Choose <Tools> from the Adjustment menu, and press **(●)**.
2. Choose <Input Selection> from the <Tools> menu, and press **(●)**.  
The <Input Selection> menu appears.
3. Select "Auto" or "Manual" with **(▲)** or **(▼)**.
4. Press **(●)** to exit the adjustment.

---

**Attention**

- When "Auto" is selected for <Input Selection>, the monitor's power-saving function works only when the all PCs are in the power-saving mode.
-

## 7-3. Making Use of USB (Universal Serial Bus)

This monitor has a hub compatible with USB. Connected to a PC compatible with USB or another USB hub, this monitor functions as a USB hub allowing connection to peripheral USB devices.

### ● Required System Environment

1. A PC equipped with a USB port or another USB hub connected to a USB compatible PC
2. Windows 2000/XP/Vista/7 or Mac OS 9.2.2 and Mac OS X 10.2 or later
3. EIZO USB cable (MD-C93)

---

#### **Attention**

- This monitor may not work depending on PC, OS or peripheral devices to be used. For USB compatibility of peripheral devices, contact their manufactures.
  - Devices connected to the USB port (upstream and downstream) work when the monitor is in power saving mode or when the power button of the monitor is Off. Therefore, power consumption of the monitor varies with connected devices even in the power saving mode.
  - When the main power switch is Off, device connected to the USB port will not operate.
- 

### ● Connection Procedure (Setup of USB Function)

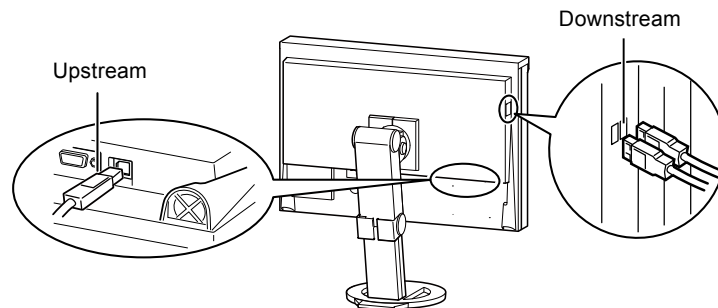

1. Connect the monitor first to a PC using the signal cable, and run the PC.
2. Connect the supplied USB cable between the downstream USB port of a USB compatible PC (or another USB hub) and the monitor's upstream USB port.  
The USB hub function is set up automatically upon connection of the USB cable.
3. Connect the peripheral USB device to the USB port (downstream) of the monitor.



## 7-4. Displaying Monitor Information

### ● Displaying signal information [Signal Info]

This function displays the information about the current input signals displayed.

1. Choose <Tools> from the Adjustment menu, and press .
2. Choose <Signal Info> from the <Tools> menu, and press .

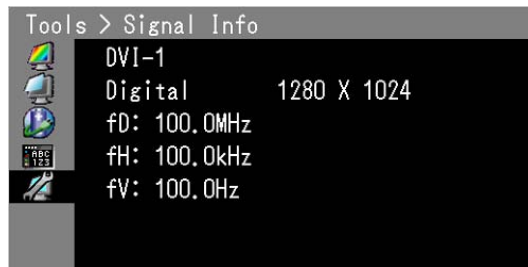

The Signal Info screen appears.

(Example)



### ● Displaying monitor information [Monitor Info]

This function displays the information about the monitor.

1. Choose <Tools> from the Adjustment menu, and press .
2. Choose <Monitor Info> from the <Tools> menu, and press .

The Monitor Info screen appears.

(Example)

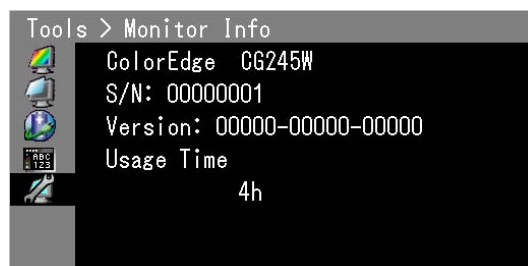

---

**Attention**

- The usage time is not always "0" due to factory inspection when you purchase the monitor.
-

## 7-5. Specifications

LCD Panel	Size		24.1-inch (610 mm) TFT color LCD
	Surface treatment		Hard Coating
	Surface hardness		3H
	Viewing angle		Viewing angle : Horizontal 178°, Vertical 178° (CR:10 or more)
	Dot Pitch		0.270 mm
	Response Time		Approx. 13ms
Horizontal Scan Frequency	Analog		24-76 kHz
	Digital		26-78 kHz
Vertical Scan Frequency	Analog		47.5-86 Hz(1600 × 1200, 1920 × 1200: 47.5-61 Hz)
	Digital		23.75-63 Hz (VGA TEXT: 69-71 Hz)
	Frame Synchronous mode	Analog	47.5-61 Hz
		Digital	23.75-30.5 Hz, 47.5-61 Hz
Resolution			1920 dots × 1200 lines
Recommended Brightness			120 cd/m <sup>2</sup> or less (with color temperature of between 5000K to 6500K)
Max. Dot Clock	Analog		170 MHz
	Digital		164.5 MHz
Max. Display Color			Approx. 1073.74 million colors (DisplayPort 10bit)
Display Area (H × V)			518.4 mm × 324.0 mm
Power Supply			100-120/200-240 VAC ±10%, 50/60Hz 1.0A/0.5A
Power Consumption	Screen Display On		100W or less (with USB load) 90W or less (without USB load)
	Power saving mode		1.0W or less (for DVI-I (Analog) single signal input, without USB load, [Input Selection] : "Manual")
	Power button Off		0.7W or less (without USB load)
	Main Power switch Off		0W
Input Signal Connector			DVI-I connector (Applicable to HDCP) × 2
			DisplayPort (Standard V1.1a, applicable to HDCP)
Analog Input Signal (Sync)			Separate, TTL, positive/ negative Composite, TTL, positive/ negative
Analog Input Signal (Video)			Analog, Positive (0.7Vp-p/75Ω)
Digital Signal (DVI) Transmission System			TMDS (Single Link)
Max. Video Signal Memory	Analog		45 (preset: 10)
	Plug & Play		
			Analog / Digital (DVI-I) : VESA DDC 2B / EDID structure 1.3 Digital (DisplayPort) : VESA DisplayPort / EDID structure 1.4
Dimensions	Main unit		566 mm (22.3 inch) × 396.5 - 553.5 mm (15.6 - 21.8 inch) × 242 - 256 mm (9.5 - 10.1 inch)
	without stand		566 mm (22.3 inch) × 382 mm (15 inch) × 92.5 mm (3.64 inch)
	with hood	Landscape	574 mm (22.6 inch) × 561 mm (22.1 inch) × 365.5 mm (14.4 inch)
		Portrait	390 mm (15.4 inch) × 646 mm (25.4 inch) × 365.5 mm (14.4 inch)
Mass	Main unit		Approx. 10.1 kg (22.3 lbs.)
	without stand		Approx. 7.1 kg (15.7 lbs.)
	with Hood		Approx. 11.1 kg (24.5 lbs.)

Movable range	Tilt	30° Up, 0° Down
	Swivel	172° Right, 172° Left
	Adjustable height	225 mm (8.9 inch) (Tilt 0°:157 mm (6.2 inch))
	Rotation	90° (clockwise)
Environmental Conditions	Temperature	Operating temperature: 0 °C - 35 °C (32 °F - 95 °F) Storage temperature: -20 °C - 60 °C (-4 °F - 140 °F)
	Humidity	Operating humidity: 20% - 80% R.H. (no condensation) Storage humidity: 10% - 80% R.H. (no condensation)
	Pressure	Operating: 700 to 1,060 hPa Storage: 200 to 1,060 hPa
USB	Standard	USB Specification Revision 2.0
	Port	Upstream port × 1, Downstream port × 2
	Communication Speed	480 Mbps (high), 12 Mbps (full), 1.5 Mbps (low)
	Supply current	Downstream: Max. 500mA/1 port

### Main default settings (factory settings)

Color Mode	Custom
PowerManager	On
Input Selection	Manual
Screen Size	Full
Outline Enhancer	0
Menu Position	Center
Language	English

# Outside Dimensions

Unit: mm (inch)

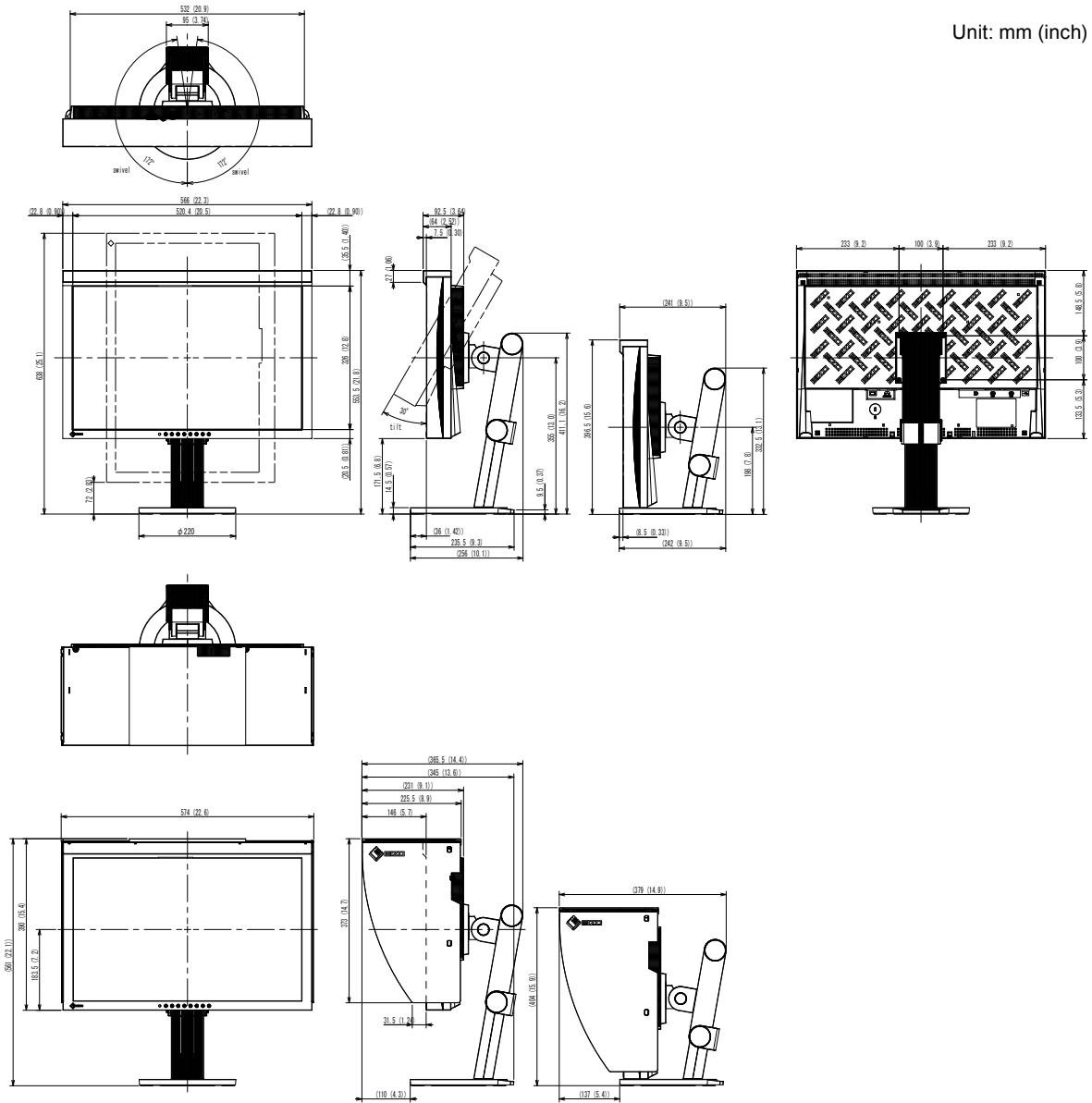

## Connector Pin Assignment

- DVI-I connector

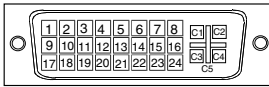

Pin No.	Signal	Pin No.	Signal	Pin No.	Signal
1	T.M.D.S. Data 2-	11	T.M.D.S. Data1/3 Shield	21	NC*
2	T.M.D.S. Data 2+	12	NC*	22	T.M.D.S. Clock shield
3	T.M.D.S. Data2/4 Shield	13	NC*	23	T.M.D.S. Clock+
4	NC*	14	+5V Power	24	T.M.D.S. Clock-
5	NC*	15	Ground (return for +5V, Hsync, and Vsync)	C1	Analog Red
6	DDC Clock (SCL)	16	Hot Plug Detect	C2	Analog Green
7	DDC Data (SDA)	17	T.M.D.S. Data0-	C3	Analog Blue
8	Analog Vertical Sync	18	T.M.D.S. Data0+	C4	Analog Horizontal Sync
9	T.M.D.S. Data1-	19	T.M.D.S. Data0/5 Shield	C5	Analog Ground(analog R,G,&B return)
10	T.M.D.S. Data1+	20	NC*		

(NC\*: No Connection)

- DisplayPort connector

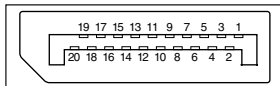

Pin No.	Signal	Pin No.	Signal	Pin No.	Signal
1	ML Lane3-	8	Ground	15	AUX CH+
2	Ground	9	ML Lane1+	16	Ground
3	ML Lane3+	10	ML Lane0-	17	AUX CH-
4	ML Lane2-	11	Ground	18	Hot Plug Detect
5	Ground	12	ML Lane0+	19	Return
6	ML Lane2+	13	CONFIG1	20	DP PWR
7	ML Lane1-	14	CONFIG2		

- USB port

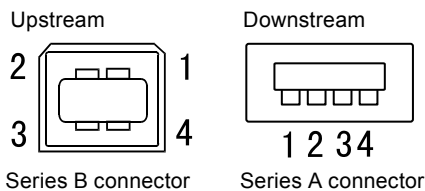

Contact No.	Signal	Remarks
1	VCC	Cable power
2	- Data	Serial data
3	+ Data	Serial data
4	Ground	Cable ground



## 7-6. Glossary

---

### **Adobe® RGB**

This is a definition of the practical RGB color space proposed by Adobe Systems in 1998. The color reproduction range (color gamut) is broader than sRGB, and is highly adaptable to such fields as printing etc.

### **Clock**

The analog input monitor needs to reproduce a clock of the same frequency as the dot clock of the graphics system in use, when the analog input signal is converted to a digital signal for image display. This is called clock adjustment. If the clock pulse is not set correctly, some vertical bars appear on the screen.

### **DCI(Digital Cinema Initiatives)**

The company was founded by an association of U.S. film studios, and this company decides the specifications for digital cinema.

### **DisplayPort**

VESA provides the digital interface standard for the digital display device. DisplayPort can transfer the video signal up to 16 bits for each channel of RGB, and the audio signal too. (This monitor supports the 8-bit video signal only.)

### **DVI (Digital Visual Interface)**

DVI is a digital interface standard. DVI allows direct transmission of the PC's digital data without loss. This adopts the TMDS transmission system and DVI connectors. There are two types of DVI connectors. One is a DVI-D connector for digital signal input only. The other is a DVI-I connector for both digital and analog signal inputs.

### **DVI DMPM (DVI Digital Monitor Power Management)**

DVI DMPM is a digital interface power-saving function. The "Monitor ON (operating mode)" and "Active Off (power-saving mode)" are indispensable for DVI DMPM as the monitor's power mode.

### **EBU(European Broadcasting Union)**

The organization also includes broadcasting offices from Europe and North Africa, and its role is to decide various technical standards etc.

### **Gain**

This is used to adjust each color parameter for red, green and blue. An LCD monitor displays the color by the light passing through the panel color filter. Red, green and blue are the three primary colors. All the colors on the screen are displayed by combining these three colors. The color tone can be changed by adjusting the light intensity (volume) passing through each color's filter.

## **Gamma**

Generally, the monitor brightness varies nonlinearly with the input signal level, which is called “Gamma Characteristic”. A small gamma value produces a low-contrast image, while a large gamma value produces a highcontrast image.

## **HDCP (High-bandwidth Digital Contents Protection)**

Digital signal coding system developed to copy-protect the digital contents, such as video, music, etc. This helps to transmit the digital contents safely by coding the digital contents sent via DVI terminal on the output side and decoding them on the input side. Any digital contents cannot be reproduced if both of the equipments on the output and input sides are not applicable to HDCP system.

## **Phase**

Phase means the sampling timing to convert the analog input signal to a digital signal. Phase adjustment is made to adjust the timing. It is recommended that phase adjustment be made after the clock is adjusted correctly.

## **Range Adjustment**

Range adjustment controls the signal output levels to display every color gradation. It is recommended that range adjustment be made before color adjustment.

## **Rec709**

Digital broadcasting (HDTV) standards defined by the ITU-R (International Telecommunication Union Radio Communication Sector).

## **Resolution**

The LCD panel consists of numerous pixels of specified size, which are illuminated to form images. This monitor consists of 1920 horizontal pixels and 1200 vertical pixels. At a resolution of 1920 x 1200, all pixels are illuminated as a full screen (1:1).

## **SMPTE-C**

One of the standards provided by the SMPTE (Society of Motion Picture and Television Engineers).

## **sRGB (Standard RGB)**

“International Standard for Red, Green, and Blue color space” A color space was defined with the aim of the color matching between applications and hardware devices, such as monitors, scanners, printers and digital cameras. As a standard default space, sRGB allows Internet users to closely match colors.

## **Temperature**

Color temperature is a method to measure the white color tone, generally indicated in degrees Kelvin. The screen becomes reddish at a low temperature, and bluish at a high temperature, like the flame temperature.

5000K: Slightly reddish white (usually used in print industry)

6500K: White called daylight color (suited for web browsing)

9300K: Slightly bluish white (usually used for television)

## **TMDs (Transition Minimized Differential Signaling)**

A signal transmission system for digital interface.

## **VESA DPMS (Video Electronics Standards Association - Display Power Management Signaling)**

VESA provides the standardization of signals from PC (graphics board) for power saving of PC monitors.

DPMS defines the signal status between PC and monitor.

## 7-7. Preset Timing

The following table shows factory preset video timing (for analog signal only).

### Attention

- Display position may be deviated depending on the PC connected, which may require screen adjustment using Adjustment menu.
- If a signal other than those listed in the table is input, adjust the screen using the Adjustment menu. However, screen display may still be incorrect even after the adjustment.
- When interlace signals are used, the screen cannot be displayed correctly even after screen adjustment using the Adjustment menu.

Resolution	Applicable signal	Frequency			Polarity	
		Dot clock: MHz	Horizontal: kHz	Vertical: Hz	Horizontal	Vertical
720 × 400	VGA TEXT	28.32	31.47	70.09	Negative	Positive
640 × 480	VGA	25.18	31.47	59.94	Negative	Negative
800 × 600	VESA	40.00	37.88	60.32	Positive	Positive
1024 × 768	VESA	65.00	48.36	60.00	Negative	Negative
1280 × 960	VESA	108.00	60.00	60.00	Positive	Positive
1280 × 1024	VESA	108.00	63.98	60.02	Positive	Positive
1600 × 1200	VESA	161.99	75.00	60.00	Positive	Positive
1680 × 1050	VESA CVT	146.25	65.29	59.95	Negative	Positive
1920 × 1080	CEA-861	148.50	67.50	60.00	Positive	Positive
1920 × 1200	VESA CVT RB	154.00	74.04	59.95	Positive	Negative



Congratulations!

The display you have just purchased carries the TCO'03 Displays label. This means that your display is designed, manufactured and tested according to some of the strictest quality and environmental requirements in the world. This makes for a high performance product, designed with the user in focus that also minimizes the Impact on our natural environment.

Some of the features of the TCO'03 Display requirements:

#### Ergonomics

- Good visual ergonomics and image quality in order to improve the working environment for the user and to reduce sight and strain problems. Important parameters are luminance, contrast, resolution, reflectance, colour rendition and image stability.

#### Energy

- Energy-saving mode after a certain time - beneficial both for the user and environment
- Electrical safety

#### Emissions

- Electromagnetic fields
- Noise emissions

#### Ecology

- The products must be prepared for recycling and the manufacturer must have a certified environmental management system such as EMAS or ISO 14000
- Restrictions on
  - chlorinated and brominated flame retardants and polymers
  - heavy metals such as cadmium, mercury and lead.

The requirements included in this label have been developed by TCO Development in co-operation with scientists, experts, users as well as manufacturers all over the world. Since the end of the 1980s TCO has been involved in influencing the development of IT equipment in a more user-friendly direction. Our labeling system with displays in 1992 and is now requested by users and IT-manufacturers all over the world.

**For more information, please visit  
[www.tcodevelopment.com](http://www.tcodevelopment.com)**

For U.S.A. , Canada, etc. (rated 100-120 Vac) Only

## FCC Declaration of Conformity

**We, the Responsible Party**

EIZO NANAOTECHNOLOGIES INC.

5710 Warland Drive, Cypress, CA 90630

Phone: (562) 431-5011

**declare that the product**

Trade name: EIZO

Model: ColorEdge CG245W

**is in conformity with Part 15 of the FCC Rules. Operation of this product is subject to the following two conditions: (1) this device may not cause harmful interference, and (2) this device must accept any interference received, including interference that may cause undesired operation.**

This equipment has been tested and found to comply with the limits for a Class B digital device, pursuant to Part 15 of the FCC Rules. These limits are designed to provide reasonable protection against harmful interference in a residential installation. This equipment generates, uses, and can radiate radio frequency energy and, if not installed and used in accordance with the instructions, may cause harmful interference to radio communications. However, there is no guarantee that interference will not occur in a particular installation. If this equipment does cause harmful interference to radio or television reception, which can be determined by turning the equipment off and on, the user is encouraged to try to correct the interference by one or more of the following measures.

- \* Reorient or relocate the receiving antenna.
- \* Increase the separation between the equipment and receiver.
- \* Connect the equipment into an outlet on a circuit different from that to which the receiver is connected.
- \* Consult the dealer or an experienced radio/TV technician for help.

Changes or modifications not expressly approved by the party responsible for compliance could void the user's authority to operate the equipment.

### Note

Use the attached specified cable below or EIZO signal cable with this monitor so as to keep interference within the limits of a Class B digital device.

- AC Cord
- Shielded Signal Cable (Enclosed)

## Canadian Notice

This Class B digital apparatus complies with Canadian ICES-003.

Cet appareil numérique de la classe B est conforme à la norme NMB-003 du Canada.

### **Hinweise zur Auswahl des richtigen Schwenkarms für Ihren Monitor**

Dieser Monitor ist für Bildschirmarbeitsplätze vorgesehen. Wenn nicht der zum Standardzubehör gehörige Schwenkarm verwendet wird, muss statt dessen ein geeigneter anderer Schwenkarm installiert werden. Bei der Auswahl des Schwenkarms sind die nachstehenden Hinweise zu berücksichtigen:

Der Standfuß muß den nachfolgenden Anforderungen entsprechen:

- a) Der Standfuß muß eine ausreichende mechanische Stabilität zur Aufnahme des Gewichtes vom Bildschirmgerät und des spezifizierten Zubehörs besitzen. Das Gewicht des Bildschirmgerätes und des Zubehörs sind in der zugehörigen Bedienungsanleitung angegeben.
- b) Die Befestigung des Standfusses muß derart erfolgen, daß die oberste Zeile der Bildschirmanzeige nicht höher als die Augenhöhe eines Benutzers in sitzender Position ist.
- c) Im Fall eines stehenden Benutzers muß die Befestigung des Bildschirmgerätes derart erfolgen, daß die Höhe der Bildschirmmitte über dem Boden zwischen 135 – 150 cm beträgt.
- d) Der Standfuß muß die Möglichkeit zur Neigung des Bildschirmgerätes besitzen (max. vorwärts: 5°, min. nach hinten  $\geq 5^\circ$ ).
- e) Der Standfuß muß die Möglichkeit zur Drehung des Bildschirmgerätes besitzen (max.  $\pm 180^\circ$ ). Der maximale Kraftaufwand dafür muß weniger als 100 N betragen.
- f) Der Standfuß muß in der Stellung verharren, in die er manuell bewegt wurde.
- g) Der Glanzgrad des Standfusses muß weniger als 20 Glanzeinheiten betragen (seidenmatt).
- h) Der Standfuß mit Bildschirmgerät muß bei einer Neigung von bis zu 10° aus der normalen aufrechten Position kippstabil sein.

### **Hinweis zur Ergonomie :**

Dieser Monitor erfüllt die Anforderungen an die Ergonomie nach EK1-ITB2000 mit dem Videosignal, 1920×1200, Digital Eingang und mindestens 60,0 Hz Bildwiederholfrequenz, non interlaced. Weiterhin wird aus ergonomischen Gründen empfohlen, die Grundfarbe Blau nicht auf dunklem Untergrund zu verwenden (schlechte Erkennbarkeit, Augenbelastung bei zu geringem Zeichenkontrast.)

„Maschinenlärminformations-Verordnung 3. GPSGV:

Der höchste Schalldruckpegel beträgt 70 dB(A) oder weniger gemäss EN ISO 7779“

## LIMITED WARRANTY

EIZO NANA CORPORATION (hereinafter referred to as “EIZO”) and distributors authorized by EIZO (hereinafter referred to as the “Distributors”) warrant, subject to and in accordance with the terms of this limited warranty (hereinafter referred to as the “Warranty”), to the original purchaser (hereinafter referred to as the “Original Purchaser”) who purchased the product specified in this document (hereinafter referred to as the “Product”) from EIZO or Distributors, that EIZO and Distributors shall, at their sole discretion, either repair or replace the Product at no charge if the Original Purchaser becomes aware within the Warranty Period (defined below) that (i) the Product malfunctions or is damaged in the course of normal use of the Product in accordance with the description in the instruction manual attached to the Product (hereinafter referred to as the “User’s Manual”), or (ii) the LCD panel and brightness of the Product cannot maintain the recommended brightness specified in the User’s Manual in the course of normal use of the Product in accordance with the description of the User’s Manual.

The period of this Warranty is five (5) years from the date of purchase of the Product subject to the usage time being less than or equal to 30,000 hours (hereinafter referred to as the “Warranty Period”), provided that the Warranty Period for the LCD panel is limited to three (3) years from the date of purchase of the Product. The brightness of the Product shall be warranted only if the Product has been used within the recommended brightness of described in the User’s Manual and the Warranty Period for the brightness is limited to three (3) years from the date of purchase of the Product subject to the usage time being less than or equal to 10,000 hours. EIZO and Distributors shall bear no liability or obligation with regard to the Product in relation to the Original Purchaser or any third parties other than as provided under this Warranty.

EIZO and Distributors will cease to hold or store any parts of the Product upon expiration of seven (7) years after the production of such parts is discontinued. In repairing the monitor, EIZO and Distributors will use renewal parts which comply with our QC standards.

The Warranty is valid only in the countries or territories where the Distributors are located. The Warranty does not restrict any legal rights of the Original Purchaser.

Notwithstanding any other provision of this Warranty, EIZO and Distributors shall have no obligation under this Warranty whatsoever in any of the cases as set forth below:

- (a) Any defect of the Product caused by freight damage, modification, alteration, abuse, misuse, accident, incorrect installation, disaster, faulty maintenance and/or improper repair by third party other than EIZO and Distributors;
- (b) Any incompatibility of the Product due to possible technical innovations and/or regulations;
- (c) Any deterioration of the sensor;
- (d) Any deterioration of display performance caused by the deterioration of expendable parts such as the LCD panel and/or backlight, etc. (e.g. changes in brightness uniformity, changes in color, changes in color uniformity, defects in pixels including burnt pixels, etc.);
- (e) Any deterioration of the Product caused by the use at higher brightness than the recommended brightness described in the User’s Manual;
- (f) Any defect of the Product caused by external equipment;
- (g) Any defect of the Product on which the original serial number has been altered or removed;
- (h) Any normal deterioration of the product, particularly that of consumables, accessories, and/or attachments (e.g. buttons, rotating parts, cables, User’s Manual, etc.); and
- (i) Any deformation, discoloration, and/or warp of the exterior of the product including that of the surface of the LCD panel.

To obtain service under the Warranty, the Original Purchaser must deliver the Product, freight prepaid, in its original package or other adequate package affording an equal degree of protection, assuming the risk of damage and/or loss in transit, to the local Distributor. The Original Purchaser must present proof of purchase of the Product and the date of such purchase when requesting services under the Warranty.

The Warranty Period for any replaced and/or repaired product under this Warranty shall expire at the end of the original Warranty Period.

EIZO OR DISTRIBUTORS ARE NOT RESPONSIBLE FOR ANY DAMAGE TO, OR LOSS OF, DATA OR OTHER INFORMATION STORED IN ANY MEDIA OR ANY PART OF ANY PRODUCT RETURNED TO EIZO OR DISTRIBUTORS FOR REPAIR.

EIZO AND DISTRIBUTORS MAKE NO FURTHER WARRANTIES, EXPRESSED OR IMPLIED, WITH RESPECT TO THE PRODUCT AND ITS QUALITY, PERFORMANCE, MERCHANTABILITY OR FITNESS FOR ANY PARTICULAR USE. IN NO EVENT SHALL EIZO OR DISTRIBUTORS BE LIABLE FOR ANY INCIDENTAL, INDIRECT, SPECIAL, CONSEQUENTIAL OR OTHER DAMAGE WHATSOEVER (INCLUDING, WITHOUT LIMITATION, DAMAGES FOR LOSS OF PROFIT, BUSINESS INTERRUPTION, LOSS OF BUSINESS INFORMATION, OR ANY OTHER PECUNIARY LOSS) ARISING OUT OF THE USE OR INABILITY TO USE THE PRODUCT OR IN ANY CONNECTION WITH THE PRODUCT, WHETHER BASED ON CONTRACT, TORT, NEGLIGENCE, STRICT LIABILITY OR OTHERWISE, EVEN IF EIZO OR DISTRIBUTORS HAVE BEEN ADVISED OF THE POSSIBILITY OF SUCH DAMAGES. THIS EXCLUSION ALSO INCLUDES ANY LIABILITY WHICH MAY ARISE OUT OF THIRD PARTY CLAIMS AGAINST THE ORIGINAL PURCHASER. THE ESSENCE OF THIS PROVISION IS TO LIMIT THE POTENTIAL LIABILITY OF EIZO AND DISTRIBUTORS ARISING OUT OF THIS LIMITED WARRANTY AND/OR SALES.



## BEGRENZTE GARANTIE

EIZO NANA O CORPORATION (im Weiteren als „EIZO“ bezeichnet) und die Vertragsimporteure von EIZO (im Weiteren als „Vertrieb(e)“ bezeichnet) garantieren dem ursprünglichen Käufer (im Weiteren als „Erstkäufer“ bezeichnet), der das in diesem Dokument vorgegebene Produkt (im Weiteren als „Produkt“ bezeichnet) von EIZO oder einem Vertrieb erworben hat, gemäß den Bedingungen dieser beschränkten Garantie (im Weiteren als „Garantie“ bezeichnet), dass EIZO und der Vertrieb nach eigenem Ermessen das Produkt entweder kostenlos reparieren oder austauschen, falls der Erstkäufer innerhalb der Garantiefrist (weiter unten festgelegt) entweder (i) eine Fehlfunktion bzw. Beschädigung des Produkts feststellt, die während des normalen Gebrauchs des Produkts gemäß den Anweisungen des zum Lieferumfang des Produkts gehörenden Benutzerhandbuchs (im Weiteren als „Benutzerhandbuch“ bezeichnet) aufgetreten ist, oder (ii) das LCD-Panel und die Helligkeit des Produkts während des normalen Gebrauchs des Produkts gemäß den Anweisungen des Benutzerhandbuchs nicht die im Benutzerhandbuch genannte empfohlene Helligkeit aufrecht erhalten können.

Die Dauer der Garantieleistung (im Weiteren als „Garantiefrist“ bezeichnet) beträgt fünf (5) Jahre ab dem Kaufdatum oder maximal 30.000 Betriebsstunden des Produkts, wobei die Garantiefrist für den LCD-Panel auf drei (3) Jahre ab dem Kaufdatum beschränkt ist. Die Helligkeit des Produkts wird nur garantiert, wenn das Produkt innerhalb der empfohlenen Helligkeit wie im Benutzerhandbuch beschrieben verwendet wird, und die Dauer der Garantiefrist für die Helligkeit beträgt drei (3) Jahre ab dem Kaufdatum des Produkts, wobei die Benutzungszeit des Produkts auf maximal 10.000 Betriebsstunden beschränkt ist. EIZO und die Vertriebe übernehmen über den Rahmen dieser Garantie hinaus hinsichtlich des Produkts keinerlei Haftung oder Verpflichtung dem Erstkäufer oder Dritten gegenüber.

EIZO und die Vertriebe verpflichten sich, Ersatzteile für das Produkt über einen Zeitraum von sieben (7) Jahren nach Einstellung der Produktion der Ersatzteile zu lagern bzw. anzubieten. EIZO und seine Vertriebspartner verpflichten sich, bei einer etwaigen Reparatur des Monitors ausschließlich Produkte gemäß den EIZO-Qualitätssicherungsstandards zu verwenden.

Diese Garantie gilt nur in Ländern oder Gebieten, in denen sich Vertriebe befinden. Die gesetzlichen Gewährleistungsrechte des Erstkäufers gegenüber dem Verkäufer werden durch diese Garantie nicht berührt.

EIZO und die Vertriebe besitzen im Rahmen dieser Garantie keinerlei Verpflichtung in den folgenden Fällen:

- (a) Produktdefekte, die auf Frachtschäden, Modifikation, Nachgestaltung, Missbrauch, Fehlbedienung, Unfälle, unsachgemäße Installation, Naturkatastrophen, fehlerhafte Wartung und/oder unsachgemäße Reparatur durch eine andere Partei als EIZO und die Vertriebe zurückzuführen sind.
- (b) Eine Inkompatibilität des Produkts aufgrund von technischen Neuerungen und/oder neuen Bestimmungen, die nach dem Kauf in Kraft treten.
- (c) Jegliche Verschlechterung des Sensors;
- (d) Jegliche Verschlechterung der Bildschirmleistung, die durch Verschleißteile wie den LCD-Panel und/oder die Hintergrundbeleuchtung usw. hervorgerufen werden (z.B. Veränderungen von Helligkeitsverteilung, Farben oder Farbverteilung, Pixeldefekte einschließlich ausgebrannter Pixel usw.).
- (e) Jegliche Abnutzung des Produkts, die auf einen Gebrauch mit einer höheren Helligkeit als die im Benutzerhandbuch genannte empfohlene Helligkeit zurückzuführen ist.
- (f) Produktdefekte, die durch externe Geräte verursacht werden.
- (g) Jeglicher Defekt eines Produkts, dessen ursprüngliche Seriennummer geändert oder entfernt wurde.
- (h) Normale Abnutzung des Produkts, insbesondere von Verbrauchsteilen, Zubehörteilen und/oder Beilagen (z.B. Tasten, drehbare Teile, Kabel, Benutzerhandbuch usw.); sowie
- (i) Verformungen, Verfärbungen und/oder Verziehungen am Produktäußeren, einschließlich der Oberfläche des LCD-Panels.

Bei Inanspruchnahme der Garantieleistung ist der Erstkäufer verpflichtet, das Produkt auf eigene Kosten und in der Originalverpackung bzw. einer anderen geeigneten Verpackung, die einen gleichwertigen Schutz gegen Transportschäden bietet, an den örtlichen Vertrieb zu übersenden, wobei der Erstkäufer das Transportrisiko gegenüber Schäden und/oder Verlust trägt. Zum Zeitpunkt der Inanspruchnahme der Garantieleistung muss der Erstkäufer einen Verkaufsbeleg vorweisen, auf dem das Kaufdatum angegeben ist.

Die Garantiefrist für ein im Rahmen dieser Garantie ausgetauschtes und/oder repariertes Produkt erlischt nach Ablauf der ursprünglichen Garantiefrist.

EIZO ODER DIE EIZO-VERTRAGSIMPORTEURE HAFTEN NICHT FÜR ZERSTÖRTE DATENBESTÄNDE ODER DIE KOSTEN DER WIEDERBESCHAFFUNG DIESER DATENBESTÄNDE AUF JEDLICHEN DATENTRÄGERN ODER TEILEN DES PRODUKTS, DIE IM RAHMEN DER GARANTIE BEI EIZO ODER DEN EIZO-VERTRAGSIMPORTEUREN ZUR REPARATUR EINGEREICHT WURDEN.

EIZO UND DIE EIZO-VERTRAGSIMPORTEURE GEBEN WEDER EXPLIZITE NOCH IMPLIZITE GARANTIE IN BEZUG AUF DIESES PRODUKT UND SEINE QUALITÄT, LEISTUNG, VERKÄUFLICHKEIT ODER EIGNUNG FÜR EINEN BESTIMMTEN ZWECK. AUF KEINEN FALL SIND EIZO ODER DIE EIZO-VERTRAGSIMPORTEURE VERANTWORTLICH FÜR JEGLICHE ZUFÄLLIGE, INDIREKTE, SPEZIELLE, FOLGE- ODER ANDERE SCHÄDEN JEDLICHER ART (EINSCHLIESSLICH OHNE JEDE BEGRENZUNG SCHÄDEN BEZÜGLICH PROFITVERLUST, GESCHÄFTSUNTERBRECHUNG, VERLUST VON GESCHÄFTSINFORMATION ODER JEDLICHE ANDEREN FINANZIELLEN EINBUSSEN), DIE DURCH DIE VERWENDUNG DES PRODUKTES ODER DIE UNFÄHIGKEIT ZUR VERWENDUNG DES PRODUKTES ODER IN JEDLICHER BEZIEHUNG MIT DEM PRODUKT, SEI ES BASIEREND AUF VERTRAG, SCHADENSERSATZ, NACHLAESSIGKEIT, STRIKTE HAFTPFLICHT ODER ANDEREN FORDERUNGEN ENTSTEHEN, AUCH WENN EIZO UND DIE EIZO-VERTRAGSIMPORTEURE IM VORAUS ÜBER DIE MÖGLICHKEIT SOLCHER SCHÄDEN INFORMIERT WURDEN. DIESER AUSSCHLUSS ENTHÄLT AUCH JEDE HAFTPFLICHT, DIE AUS FORDERUNGEN DRITTER GEGEN DEN ERSTKÄUFER ENTSTEHEN KANN. ZWECK DIESER KLAUSEL IST ES, DIE HAFTUNG VON EIZO UND DEN VERTRIEBEN GEGENÜBER FORDERUNGEN ZU BEGRENZEN, DIE AUS DIESER BESCHRÄNKTEN GARANTIE UND/ODER DEM VERKAUF ENTSTEHEN KÖNNEN.

## GARANTIE LIMITÉE

EIZO NANA CORPORATION (ci-après dénommé « **EIZO** ») et les distributeurs autorisés par EIZO (ci-après dénommés « **Distributeurs** »), sous réserve et conformément aux termes de cette garantie limitée (ci-après dénommée « **Garantie** »), garantissent à l'acheteur initial (ci-après dénommé « **Acheteur initial** ») du produit spécifié dans la présente (ci-après dénommé « **Produit** ») acheté auprès d'EIZO ou de Distributeurs agréés EIZO, que EIZO et ses Distributeurs auront pour option de réparer ou remplacer gratuitement le Produit si l'Acheteur initial constate, pendant la Période de garantie (définie ci-dessous), (i) qu'il y a un dysfonctionnement ou que le Produit a subi un dommage dans le cadre d'une utilisation normale du Produit conformément à la description du mode d'emploi qui accompagne le Produit (ci-après dénommé « **Manuel d'utilisateur** »), ou (ii) que le panneau LCD et la luminosité du Produit ne peuvent pas maintenir la luminosité recommandée spécifiée dans le Manuel d'utilisation dans le cadre d'une utilisation normale du Produit, conformément à la description du Manuel d'utilisation.

La période de cette Garantie est limitée à cinq (5) ans à partir de la date d'achat du Produit sous réserve que sa durée d'utilisation soit inférieure ou égale à 30 000 heures (ci-après dénommée « **Période de garantie** »). La Période de garantie du panneau LCD est limitée à trois (3) ans à partir de la date d'achat du Produit. La luminosité du Produit ne sera garantie que si le Produit a été utilisé conformément à la luminosité recommandée dans le Manuel d'Utilisation et la Période de Garantie en matière de luminosité est limitée à trois (3) ans à compter de la date d'achat du Produit sous réserve que la durée d'utilisation soit inférieure ou égale à 10 000 heures. EIZO et ses Distributeurs déclinent toute responsabilité ou obligation concernant ce Produit face à l'Acheteur initial ou à toute autre personne à l'exception de celles stipulées dans la présente Garantie.

EIZO et ses Distributeurs cesseront de tenir ou conserver en stock toute pièce de ce Produit après l'expiration de la période de sept (7) ans suivant l'arrêt de la production de telles pièces. Pour réparer le moniteur, EIZO et ses distributeurs utiliseront des pièces de rechange conformes à nos normes de contrôle qualité.

La Garantie est valable uniquement dans les pays ou les territoires où se trouvent les Distributeurs. La Garantie ne limite aucun des droits reconnus par la loi à l'Acheteur initial.

Nonobstant toute autre clause de cette Garantie, EIZO et ses Distributeurs n'auront d'obligation dans le cadre de cette Garantie pour aucun des cas énumérés ci-dessous :

- (a) Tout défaut du Produit résultant de dommages occasionnés lors du transport, d'une modification, d'une altération, d'un abus, d'une mauvaise utilisation, d'un accident, d'une installation incorrecte, d'un désastre, d'un entretien et/ou d'une réparation incorrects effectués par une personne autre que EIZO ou ses Distributeurs ;
- (b) Toute incompatibilité du Produit résultant d'améliorations techniques et/ou réglementations possibles ;
- (c) Toute détérioration du capteur ;
- (d) Toute détérioration des performances d'affichage causée par la détérioration des éléments consommables tels que le panneau LCD et/ou le rétroéclairage, etc. (par exemple, des changements de l'uniformité de la luminosité, des changements de couleur, des changements de l'uniformité des couleurs, des défauts de pixels, y compris des pixels brûlés, etc.) ;
- (e) Toute détérioration du Produit causée par l'utilisation d'une luminosité plus élevée que la luminosité recommandée, telle que décrite dans le Manuel d'utilisation ;
- (f) Tout défaut du Produit causé par un appareil externe ;
- (g) Tout défaut d'un Produit sur lequel le numéro de série original a été altéré ou supprimé ;
- (h) Toute détérioration normale du Produit, particulièrement celle des consommables, des accessoires et/ou des pièces reliées au Produit (touches, éléments pivotants, câbles, Manuel d'utilisation etc.), et
- (i) Toute déformation, décoloration, et/ou gondolage de l'extérieur du Produit, y compris celle de la surface du panneau LCD.

Pour bénéficier d'un service dans le cadre de cette Garantie, l'Acheteur initial doit renvoyer le Produit port payé, dans son emballage d'origine ou tout autre emballage approprié offrant un degré de protection équivalent, au Distributeur local, et assumera la responsabilité des dommages et/ou perte possibles lors du transport. L'Acheteur initial doit présenter une preuve d'achat du Produit comprenant sa date d'achat pour bénéficier de ce service dans le cadre de la Garantie.

La Période de garantie pour tout Produit remplacé et/ou réparé dans le cadre de cette Garantie expirera à la fin de la Période de garantie initiale.

EIZO OU SES DISTRIBUTEURS NE SAURAIENT ÊTRE TENUS RESPONSABLES DES DOMMAGES OU PERTES DE DONNÉES OU D'AUTRES INFORMATIONS STOCKÉES DANS UN MÉDIA QUELCONQUE OU UNE AUTRE PARTIE DU PRODUIT RENVOYÉ À EIZO OU AUX DISTRIBUTEURS POUR RÉPARATION.

AUCUNE AUTRE GARANTIE, EXPLICITE OU TACITE, N'EST OFFERTE PAR EIZO ET SES DISTRIBUTEURS CONCERNANT LE PRODUIT ET SES QUALITÉS, PERFORMANCES, QUALITÉ MARCHANDE OU ADAPTATION À UN USAGE PARTICULIER. EN AUCUN CAS, EIZO OU SES DISTRIBUTEURS NE SERONT RESPONSABLES DES DOMMAGES FORTUITS, INDIRECTS, SPÉCIAUX, INDUITS, OU DE TOUT AUTRE DOMMAGE QUEL QU'IL SOIT (Y COMPRIS, SANS LIMITATION, LES DOMMAGES RÉSULTANT D'UNE PERTE DE PROFIT, D'UNE INTERRUPTION D'ACTIVITÉS, D'UNE PERTE DE DONNÉES COMMERCIALES, OU DE TOUT AUTRE MANQUE À GAGNER) RÉSULTANT DE L'UTILISATION OU DE L'INCAPACITÉ D'UTILISER LE PRODUIT OU AYANT UN RAPPORT QUELCONQUE AVEC LE PRODUIT, QUE CE SOIT SUR LA BASE D'UN CONTRAT, D'UN TORT, D'UNE NÉGLIGENCE, D'UNE RESPONSABILITÉ STRICTE OU AUTRE, MÊME SI EIZO OU SES DISTRIBUTEURS ONT ÉTÉ AVERTIS DE LA POSSIBILITÉ DE TELS DOMMAGES. CETTE LIMITATION INCLUT AUSSI TOUTE RESPONSABILITÉ QUI POURRAIT ÊTRE SOULEVÉE LORS DES RÉCLAMATIONS D'UN TIERS CONTRE L'ACHETEUR INITIAL. L'ESSENCE DE CETTE CLAUSE EST DE LIMITER LA RESPONSABILITÉ POTENTIELLE DE EIZO ET DE SES DISTRIBUTEURS RÉSULTANT DE CETTE GARANTIE LIMITÉE ET/OU DES VENTES.

## GARANTÍA LIMITADA

EIZO NANA CORPORATION (en lo sucesivo “EIZO”) y sus distribuidores autorizados por EIZO (en lo sucesivo los “Distribuidores”), con arreglo y de conformidad con los términos de esta garantía limitada (en lo sucesivo la “Garantía”), garantizan al comprador original (en lo sucesivo el “Comprador original”) que compró el producto especificado en este documento (en lo sucesivo el “Producto”) a EIZO o a sus Distribuidores, que EIZO y sus Distribuidores, a su propio criterio, repararán o sustituirán el Producto de forma gratuita si el Comprador original detecta dentro del periodo de la Garantía (indicado posteriormente) que: (i) el Producto no funciona correctamente o que se ha averiado durante el uso normal del mismo de acuerdo con las indicaciones del manual de instrucciones suministrado con el Producto (en lo sucesivo el “Manual del usuario”); o (ii) el panel LCD y el brillo del Producto no pueden mantener el brillo recomendado que se especifica en el Manual del usuario durante el uso normal del Producto de acuerdo con las descripciones del Manual del usuario.

El periodo de esta Garantía es de cinco (5) años a partir de la fecha de compra del Producto, a condición de que se respete el límite máximo de tiempo de uso de 30.000 horas (en adelante designado como el “Periodo de Garantía”), con la estipulación de que el Periodo de Garantía del panel LCD está limitado a tres (3) años a partir de la fecha de compra del Producto. El brillo del Producto estará garantizado únicamente si el Producto se ha usado dentro los límites de brillo recomendados que se describen en el Manual del usuario y el Periodo de Garantía del brillo está limitado a tres (3) años a partir de la fecha de compra del Producto, a condición de que se respete el límite máximo de tiempo de uso de 10.000 horas. EIZO y sus Distribuidores no tendrán ninguna responsabilidad ni obligación con respecto al Producto para con el Comprador original ni con terceros que no sean las estipuladas en la presente Garantía.

EIZO y sus Distribuidores no estarán obligados a suministrar cualquier recambio del Producto una vez pasados siete (7) años desde que se deje de fabricar el mismo. Para la reparación del monitor, EIZO y los distribuidores utilizarán repuestos que cumplan con nuestros estándares de control de calidad.

La Garantía es válida sólo en los países y territorios donde están ubicados los Distribuidores. La Garantía no restringe ningún derecho legal del Comprador original.

A pesar de las estipulaciones de esta Garantía, EIZO y sus Distribuidores no tendrán obligación alguna bajo esta Garantía en ninguno de los casos expuestos a continuación:

- (a) Cualquier defecto del Producto causado por daños en el transporte, modificación, alteración, abuso, uso incorrecto, accidente, instalación incorrecta, desastre, mantenimiento incorrecto y/o reparación indebida realizada por un tercero que no sea EIZO o sus Distribuidores.
- (b) Cualquier incompatibilidad del Producto debida a posibles innovaciones técnicas y/o reglamentaciones.
- (c) Cualquier deterioro del sensor;
- (d) Cualquier deterioro en el rendimiento de la visualización causado por fallos en las piezas consumibles como el panel de cristal líquido y/o la luz de fondo, etc. (p.ej. cambios de uniformidad del brillo, cambios de color, cambios de uniformidad del color, defectos de píxeles, incluyendo píxeles muertos, etc.).
- (e) Cualquier deterioro del Producto causado por el uso continuado con un brillo superior al recomendado en el Manual del usuario.
- (f) Cualquier defecto del Producto causado por un equipo externo.
- (g) Cualquier defecto del Producto en el que haya sido alterado o borrado el número de serie original.
- (h) Cualquier deterioro normal del Producto, y en particular de las piezas consumibles, accesorios y demás (p. ej. botones, piezas giratorias, cables, Manual del usuario, etc.).
- (i) Cualquier deformación, decoloración y/o alabeo del exterior del Producto incluida la superficie del panel LCD.

Para obtener servicio en los términos de esta Garantía, el Producto deberá ser enviado por el Comprador original, a su Distribuidor local, con el transporte previamente pagado, en el embalaje original u otro embalaje adecuado que ofrezca el mismo grado de protección, asumiendo el riesgo de daños y/o pérdida del Producto durante el transporte. El Comprador original deberá presentar un comprobante de compra del Producto en el que se refleje la fecha de compra del mismo cuando lo solicite el servicio de Garantía.

El Periodo de garantía para cualquier Producto reemplazado y/o reparado en los términos de esta Garantía expirará al vencer el Periodo de garantía original.

EIZO O LOS DISTRIBUIDORES AUTORIZADOS DE EIZO NO SE RESPONSABILIZAN DE NINGÚN DAÑO O PÉRDIDA QUE PUEDAN SUFRIR LOS DATOS U OTRA INFORMACIÓN ALMACENADA EN CUALQUIER MEDIO O CUALQUIER PARTE DE CUALQUIER PRODUCTO DEVUELTO A EIZO O A LOS DISTRIBUIDORES DE EIZO PARA SU REPARACIÓN.

EIZO Y LOS DISTRIBUIDORES AUTORIZADOS DE EIZO NO OFRECEN NINGUNA OTRA GARANTÍA, IMPLÍCITA NI EXPLÍCITA, CON RESPECTO AL PRODUCTO Y A SU CALIDAD, RENDIMIENTO, COMERCIABILIDAD E IDONEIDAD PARA CUALQUIER USO EN PARTICULAR. EN NINGÚN CASO SERÁN EIZO O LOS DISTRIBUIDORES AUTORIZADOS DE EIZO RESPONSABLES DE NINGÚN DAÑO EMERGENTE, INDIRECTO, ESPECIAL, INHERENTE O CUALQUIERA QUE SEA (INCLUYENDO, SIN LIMITACIÓN, DAÑOS POR LUCRO CESANTE, INTERRUPCIÓN DE LA ACTIVIDAD COMERCIAL, PÉRDIDA DE INFORMACIÓN COMERCIAL O CUALQUIER OTRA PÉRDIDA PECUNIARIA) QUE SE DERIVE DEL USO O IMPOSIBILIDAD DE USO DEL PRODUCTO O EN RELACIÓN CON EL PRODUCTO, YA SEA BASADO EN CONTRATO, POR AGRAVIO, NEGLIGENCIA, ESTRUCTIVA RESPONSABILIDAD O CUALQUIERA QUE SEA, AUN CUANDO SE HAYA ADVERTIDO A EIZO O A LOS DISTRIBUIDORES DE EIZO DE LA POSIBILIDAD DE TALES DAÑOS. ESTA EXCLUSIÓN TAMBIÉN ABARCA CUALQUIER RESPONSABILIDAD QUE PUEDA DERIVARSE DE RECLAMACIONES HECHAS POR UN TERCERO CONTRA EL COMPRADOR ORIGINAL. LA ESENCIA DE ESTA ESTIPULACIÓN ES LIMITAR LA RESPONSABILIDAD POTENCIAL DE EIZO Y LOS DISTRIBUIDORES QUE PUDIERA DERIVARSE DE ESTA GARANTÍA LIMITADA Y/O VENTAS.

## GARANZIA LIMITATA

EIZO NANA CORPORATION (a cui si farà riferimento da qui in poi con “EIZO”) ed i Distributori autorizzati da EIZO (a cui si farà riferimento da qui in poi con “Distributori”) garantiscono, secondo i termini di questa garanzia limitata (a cui si farà riferimento da qui in poi con “Garanzia”) all’acquirente originale (a cui si farà riferimento da qui in poi con “Acquirente originale”) che ha acquistato il prodotto specificato in questo documento (a cui si farà riferimento da qui in poi con “Prodotto”) da EIZO o dai suoi Distributori, che EIZO e i distributori, a loro discrezione, ripareranno o sostituiranno il Prodotto senza addebito se l’Acquirente originale trova, entro il periodo della Garanzia (definito sotto), che (i) il Prodotto malfunziona e si è danneggiato nel corso del suo normale utilizzo osservando le indicazioni del manuale di istruzioni allegato al Prodotto (a cui si farà riferimento da qui in poi con “Manuale utente”), o che (ii) il pannello LCD e la luminosità del Prodotto non possono mantenere la luminosità raccomandata specificata nel Manuale utente nel corso del normale utilizzo del Prodotto osservando le indicazioni del Manuale utente.

Il periodo di questa Garanzia è di cinque (5) anni dalla data di acquisto del Prodotto, a condizione che il tempo d’utilizzo sia inferiore o uguale a 30.000 ore (a cui si farà riferimento da qui in poi con “Periodo di Garanzia”), tenendo però presente che il Periodo di Garanzia del pannello LCD è limitato a tre (3) anni dalla data di acquisto del Prodotto. La luminosità del Prodotto verrà garantita solo se il Prodotto è stato usato entro la luminosità raccomandata nel Manuale utente e se il Periodo di garanzia per la luminosità è limitato a tre (3) anni dalla data di acquisto del Prodotto a condizione che il tempo di utilizzo sia inferiore o uguale a 10.000 ore. EIZO e i suoi Distributori non si assumono alcuna responsabilità e non hanno alcun obbligo riguardo al Prodotto verso l’Acquirente originale o terzi diversi da quelli relativi a questa Garanzia.

EIZO e i suoi Distributori cesseranno di tenere o di conservare qualsiasi ricambio del Prodotto allo scadere di sette (7) anni dopo che la produzione di tali ricambi è stata terminata. Per la riparazione del monitor, EIZO e i Distributori utilizzeranno parti di ricambio conformi ai nostri standard di controllo della qualità.

La Garanzia è valida soltanto nei paesi dove ci sono i Distributori EIZO. La Garanzia non limita alcun diritto legale dell’Acquirente originale.

Indipendentemente da qualsiasi altra condizione di questa Garanzia, EIZO e i suoi Distributori non avranno alcun obbligo derivante da questa Garanzia in ognuno dei casi elencati di seguito:

- (a) Qualsiasi difetto del Prodotto causato da danni di trasporto, modifiche, alterazioni, abusi, usi impropri, incidenti, installazione errata, calamità, manutenzione errata e/o riparazioni improprie eseguite da terze parti che non siano EIZO o i suoi Distributori.
- (b) Qualsiasi incompatibilità del Prodotto dovuta a possibili innovazioni tecniche e/o normative.
- (c) Qualsiasi deterioramento del sensore;
- (d) Qualsiasi deterioramento delle prestazioni dello schermo causato dal deterioramento delle parti consumabili, come il pannello LCD e/o la retroilluminazione, ecc. (per esempio: cambiamenti di uniformità della luminosità, cambiamenti di colore, cambiamenti di uniformità del colore, difetti dei pixel, inclusi i pixel bruciati, ecc.).
- (e) Qualsiasi deterioramento del Prodotto causato dal suo utilizzo ad una luminosità più alta di quella raccomandata nel Manuale utente.
- (f) Qualsiasi difetto del Prodotto causato da apparecchiature esterne.
- (g) Qualsiasi difetto del Prodotto in cui il numero di serie originale sia stato alterato o rimosso.
- (h) Qualsiasi normale deterioramento del Prodotto, in particolar modo nelle sue parti di consumo, accessori, e/o attacchi (per esempio: tasti, parti rotanti, cavi, Manuale dell’utente, ecc.).
- (i) Qualsiasi tipo di deformazione, scolorimento, e/o di involucro esterno del Prodotto inclusa la superficie del pannello LCD.

Per ricevere assistenza tecnica con questa Garanzia, l’Acquirente originale deve inviare il Prodotto, con trasporto pre-pagato, nella sua confezione originale o altra confezione adeguata che fornisce un livello analogo di protezione, assumendosi il rischio di danni e/o perdita in transito, al Distributore locale. L’Acquirente originale deve presentare la prova di acquisto che stabilisce la data di acquisto del Prodotto quando richiede servizio sotto Garanzia.

Il Periodo di garanzia per qualsiasi Prodotto sostituito e/o riparato sotto questa Garanzia scade alla fine del Periodo di garanzia originale.

EIZO O I SUOI DISTRIBUTORI NON SONO RESPONSABILI PER QUALSIASI DANNO O PERDITA DI DATI O ALTRE INFORMAZIONI MEMORIZZATI SU QUALSIASI SUPPORTO O QUALSIASI PARTE DI QUALSIASI PRODOTTO INVIATO A EIZO O I SUOI DISTRIBUTORI PER RIPARAZIONI.

EIZO E I SUOI DISTRIBUTORI NON OFFRONO ALCUNA GARANZIA ADDIZIONALE, IMPLICITA O ESPlicita, RIGUARDO IL PRODOTTO E LA SUA QUALITÀ, PRESTAZIONI, VENDIBILITÀ O APPROPRIATEZZA PER QUALSIASI USO PARTICOLARE. IN NESSUN CASO EIZO O I DISTRIBUTORI EIZO AUTORIZZATI SARANNO RESPONSABILI PER QUALSIASI DANNO ACCIDENTALE, INDIRECTO, SPECIALE, CONSEGUENTE O DI QUALSIASI ALTRA NATURA (INCLUSI, SENZA LIMITI, DANNI PER PERDITA DI PROFITTI, INTERRUZIONE DELLE ATTIVITÀ, PERDITA DI INFORMAZIONI D’AFFARI O QUALSIASI ALTRA PERDITA PECUNIARIA) DERIVANTI DALL’USO O DALL’IMPOSSIBILITÀ DI USARE IL PRODOTTO O IN QUALSIASI RELAZIONE AL PRODOTTO, SIA SU BASE DI CONTRATTO, TORTO, NEGLIGENZA, STRETTA RESPONSABILITÀ O ALTRIMENTI, ANCHE SE EIZO O I DISTRIBUTORI EIZO AUTORIZZATI SONO STATI AVVERTITI DELLA POSSIBILITÀ DI TALI DANNI. QUESTA ESCLUSIONE INCLUDE ANCHE QUALSIASI RESPONSABILITÀ CHE POSSA INSORGERE DA RECLAMI DI TERZI CONTRO L’ACQUIRENTE ORIGINALE. L’ESSENZA DI QUESTO PROVVEDIMENTO È LIMITARE LA RESPONSABILITÀ POTENZIALE DI EIZO E DEI DISTRIBUTORI DERIVANTE DA QUESTA GARANZIA LIMITATA E/O DALLE VENDITE.

## BEGRÄNSAD GARANTI

EIZO NANA CORPORATION (nedan kallat **"EIZO"**) och EIZOs auktoriserade distributörer (nedan kallade **"Distributörer"**) garanterar i enlighet med villkoren i denna begränsade garanti (nedan kallad **"Garantin"**) den ursprungliga köparen (nedan kallad den **"Ursprunglige köparen"**) som köpte den i dokumentet specificerade produkten (nedan kallad **"Produkten"**) från EIZO eller Distributörer, att EIZO eller Distributörer enligt eget gottfinnande kostnadsfritt antingen reparera eller byta ut den defekta Produkten om den Ursprunglige köparen inom Garantiperioden (definieras nedan) upptäcker att (i) Produkten fungerar felaktigt eller skadas under normal användning av Produkten i enlighet med beskrivningen i bruksanvisningen (nedan kallad **"Bruksanvisning"**) eller att (ii) Produktens LCD-panel och ljusstyrka inte kan bibehålla den rekommenderade ljusstyrkan som anges i Bruksanvisningen under normal användning av Produkten i enlighet med beskrivningen i Bruksanvisningen.

Garantiperioden är begränsad till fem (5) år från datumet för Produktens inköp eller, om detta inträffar tidigare, begränsat till utlöpanget av 30 000 timmars användning (häri kallad **"Garantiperioden"**) av Produkten. Garantiperioden för Produktens LCD-panel är begränsad till tre (3) år från datumet för Produktens inköp. Garantin gäller för Produktens ljusstyrka endast då den har använts inom den rekommenderade ljusstyrkan, som beskriven i Bruksanvisningen och Garantiperioden för ljusstyrkan är begränsad till tre (3) år från datum för Produktens inköp eller, om detta inträffar tidigare, begränsat till utlöpanget av 10 000 timmars användning. EIZO och Distributörer ska inte under några villkor ha något annat ansvar än vad som anges i denna garanti gällande Produkten i relation till den Ursprunglige köparen eller tredje part.

EIZO och Distributörer kommer att upphöra med lagerhållning av Produktens delar efter sju (7) år efter att produktionen av dessa delar upphört. När skärmen repareras använder EIZO och distributörer reservdelar som uppfyller våra kvalitetsstandarder.

Garantin är endast giltig i de länder där det finns Distributörer. Garantin begränsar inte några av den Ursprunglige köparens lagstadgade rättigheter.

Oavsett andra villkor i denna garanti ska inte EIZO Distributörer under några villkor ha något ansvar i något av de fall som beskrivs nedan:

- (a) När någon bristfällighet hos Produkten kan härledas till att ha uppstått vid frakt, modifiering, ändring, felaktigt handhavande, olycka, felaktig installation, katastrof, felaktigt underhåll och/eller felaktig reparation utförd av tredje part annan än EIZO och Distributörer.
- (b) Alla former av inkompatibilitet hos Produkten på grund av möjliga tekniska innovationer och/eller bestämmelser.
- (c) Alla försämringar av sensorn;
- (d) Alla försämringar av bildens prestanda beroende på förbrukningsdelar så som LCD-panel och/eller bakgrundsbelysning etc. (t.ex. ändringar i ljusstyrkans jämnhet, färg, färgjämnhet, defekta pixlar inklusive brända pixlar etc.).
- (e) Alla försämringar av Produkten orsakat av användning av en högre ljusstyrka än den i Bruksanvisningen rekommenderade ljusstyrkan.
- (f) Alla defekter hos Produkten som orsakats av extern utrustning.
- (g) Alla defekter hos Produkten på vilken det ursprungliga serienumret har ändrats eller avlägsnats.
- (h) All normal försämring av Produkten, speciellt förbrukningsartiklar, tillbehör och/eller yttre delar (t.ex. knappar, roterande delar, kablar, Bruksanvisningen etc.).
- (i) Varje deformation, missfärgning och/eller skevhet av Produktens yttre inklusive ytan på LCD-panelen.

För att erhålla service under denna garanti måste den Ursprunglige köparen (med hänseende till risken för skada och/eller förlust under transport) leverera Produkten till närmaste Distributör med förebetalad frakt, i dess ursprungliga förpackning eller annan fullgod förpackning som ger likvärdigt skydd. Den Ursprunglige köparen måste kunna visa inköpsbevis för Produkten som klargör Produktens inköpsdatum vid begäran av garantiservice.

Garantiperioden för alla utbytta och/eller reparerade produkter under denna garanti skall upphöra vid utgången av den ursprungliga Garantiperioden.

EIZO ELLER DISTRIBUTÖRER ÄR INTE ANSVARIGA FÖR NÅGON FORM AV SKADA ELLER FÖRLUST AV DATA ELLER ANNAN INFORMATION SOM HAR LAGRATS I NÅGON FORM AV MEDIA ELLER ANNAN DEL AV NÅGON PRODUKT SOM HAR RETURNERATS TILL EIZO ELLER DISTRIBUTÖRER FÖR REPARATION.

EIZO OCH DISTRIBUTÖRERNA GARANTERAR INGET, UTTRYCKLIGEN ELLER UNDERFÖRSTÅTT, VAD BETRÄFFAR PRODUKTEN OCH DESS KVALITET, PRESTANDA, SÄLJBARHET ELLER LÄMPLIGHET FÖR NÅGON FORM AV SPECIELL ANVÄNDNING. UNDER INGA OMSTÄNDIGHETER SKALL EIZO ELLER DISTRIBUTÖRERNA HÅLLAS ANSVARIGA FÖR NÅGRA SOM HELST UNDERORDNADE, INDIREKTA, SPECIELLA, DÄRAV FÖLJANDE ELLER ÖVRIGA SKADOR (INKLUSIVE, UTAN BEGRÄNSNING TILL, SKADOR FÖR FÖRLUST AV INKOMST, AVBRUTEN AFFÄRSRÖRELSE, FÖRLUST AV AFFÄRSINFORMATION ELLER ANNAN SÄRSKILD FÖRLUST) SOM UPPSTÅTT SOM ETT RESULTAT AV ANVÄNDNING ELLER OFÖRMÅGA ATT ANVÄNDA PRODUKTEN ELLER I NÅGON FORM AV ANSLUTNING TILL PRODUKTERNA, VARE SIG DETTA GRUNDAS PÅ KONTRAKT, ÅTALBAR HANDLING, FÖRSUMMLIGHET, ANSVARSSKYLDIGHET ELLER ANNAT, ÄVEN OM EIZO ELLER DISTRIBUTÖRERNA HAR INFORMERATS BETRÄFFANDE MÖJLIGHET ATT SÅDANA SKADOR FÖRELIGGER. DETTA UNDANTAG OMFATTAR ÄVEN ALL FORM AV ANSVARSSKYLDIGHET SOM KAN UPPSTÅ GENOM EN TREDJE PARTS ANSPRÅK GENTEMOT DEN URSPRUNGLIGE KÖPAREN. GRUNDBESTÅNDSDELEN I BESTÄMMELSEN ÄR ATT BEGRÄNSA DET EVENTUELLA ANSVARSTAGANDET FÖR EIZO OCH DISTRIBUTÖRERNA SOM KAN UPPSTÅ GENOM DENNA BEGRÄNSADE GARANTI OCH/ELLER FÖRSÄLJNING.

## ΠΕΡΙΟΡΙΣΜΕΝΗ ΕΓΓΥΗΣΗ

Η ΕΙΖΟ NANAΟ CORPORATION (στο εξής «**ΕΙΖΟ**») και οι διανομείς που εξουσιοδοτεί η ΕΙΖΟ (στο εξής «**Διανομείς**») παρέχουν εγγύηση, υποκείμενη και σύμφωνα με τους όρους της παρούσας περιορισμένης εγγύησης (στο εξής «**Εγγύηση**»), στον αρχικό αγοραστή (στο εξής «**Αρχικός Αγοραστής**») ο οποίος αγόρασε το προϊόν που καθορίζεται στο παρόν έγγραφο (στο εξής «**Προϊόν**») από την ΕΙΖΟ ή τους Διανομείς, η οποία εξασφαλίζει ότι η ΕΙΖΟ και οι Διανομείς, σύμφωνα με τη διακριτή ευχέρειά τους, είτε θα επισκευάσουν είτε θα αντικαταστήσουν το Προϊόν χωρίς χρέωση εάν ο Αρχικός Αγοραστής αντιληφθεί εντός της Περιόδου Εγγύησης (ορίζεται κατωτέρω) ότι (i) το Προϊόν δυσλειτουργεί ή έχει υποστεί βλάβη κατά τη διάρκεια κανονικής χρήσης του Προϊόντος σύμφωνα με την περιγραφή στο εγχειρίδιο χρήσης που συνοδεύει το Προϊόν (στο εξής «**Εγχειρίδιο Χρήστη**»), ή (ii) η οθόνη LCD και η φωτεινότητα του Προϊόντος δεν μπορούν να διατηρήσουν την συνιστώμενη φωτεινότητα που καθορίζεται στο Εγχειρίδιο Χρήστη κατά τη διάρκεια κανονικής χρήσης του Προϊόντος σύμφωνα με την περιγραφή στο Εγχειρίδιο Χρήστη.

Η περίοδος της παρούσας Εγγύησης είναι πέντε (5) έτη από την ημερομηνία αγοράς του Προϊόντος με την προϋπόθεση ότι ο χρόνος χρήσης είναι μικρότερος ή ίσος με 30.000 ώρες (στο εξής «**Περίοδος Εγγύησης**») και με την προϋπόθεση ότι η Περίοδος Εγγύησης για την οθόνη LCD περιορίζεται σε τρία (3) έτη από την ημερομηνία αγοράς του Προϊόντος. Η εγγύηση θα καλύπτει τη φωτεινότητα του Προϊόντος μόνον εάν το Προϊόν έχει χρησιμοποιηθεί εντός του συνιστώμενου εύρους φωτεινότητας που περιγράφεται στο Εγχειρίδιο Χρήστη και η Περίοδος Εγγύησης για τη φωτεινότητα περιορίζεται σε τρία (3) χρόνια από την ημερομηνία αγοράς του Προϊόντος με την προϋπόθεση ότι ο χρόνος χρήσης είναι μικρότερος ή ίσος με 10.000 ώρες. Η ΕΙΖΟ και οι Διανομείς δεν φέρουν καμία ευθύνη ή υποχρέωση όσον αφορά το Προϊόν σε σχέση με τον Αρχικό Αγοραστή ή οποιοδήποτε τρίτο μέρος, ούτε άλλη ευθύνη διαφορετική από αυτήν που παρέχεται στην παρούσα Εγγύηση.

Η ΕΙΖΟ και οι Διανομείς θα παύσουν να διατηρούν ή να αποθηκεύουν τυχόν εξαρτήματα του Προϊόντος κατόπιν της λήξης των επτά (7) ετών μετά τη διακοπή της παραγωγής τέτοιων εξαρτημάτων. Κατά την επίσκεψή της οθόνης, η ΕΙΖΟ και οι Διανομείς θα χρησιμοποιήσουν ανταλλακτικά επισκευής που συμμορφώνονται με τα πρότυπά μας για τη Διασφάλιση Ποιότητας.

Η Εγγύηση ισχύει μόνο σε χώρες ή περιοχές όπου βρίσκονται οι Διανομείς. Η Εγγύηση δεν περιορίζει οποιαδήποτε νόμιμα δικαιώματα του Αρχικού Αγοραστή.

Λαμβανομένης υπόψη κάθε διάταξης της παρούσας Εγγύησης, η ΕΙΖΟ και οι Διανομείς δεν θα έχουν καμία απολύτως υποχρέωση σύμφωνα με την παρούσα Εγγύηση σε οποιαδήποτε από τις περιπτώσεις που διατυπώνονται κατωτέρω:

- (α) Τυχόν ελάττωμα του Προϊόντος που προκαλείται από ζημιά κατά τη μεταφορά, τροποποίηση, αλλαγή, κατάχρηση, λανθασμένη χρήση, ατύχημα, λανθασμένη εγκατάσταση, καταστροφή, εσφαλμένη συντήρηση ή/και λανθασμένη επισκευή από τρίτο μέρος εκτός της ΕΙΖΟ και των Διανομείων,
- (β) Τυχόν ασυμβατότητα του Προϊόντος λόγω πιθανών τεχνικών καινοτομιών ή/και κανονισμών,
- (γ) Τυχόν επιδείνωση του αισθητήρα
- (δ) Τυχόν επιδείνωση της απόδοσης οθόνης που προκαλείται από τη φθορά αναλώσιμων εξαρτημάτων όπως της οθόνης LCD ή/και του φωτός υποβάθρου, κτλ. (π.χ. αλλαγές στην ομοιομορφία φωτεινότητας, αλλαγές στο χρώμα, αλλαγές στην ομοιομορφία χρώματος, ελαττώματα σε ρικελ περιλαμβανομένων των καμένων ρικελ, κ.λ.π.),
- (ε) Τυχόν επιδείνωση του Προϊόντος λόγω χρήσης σε υψηλότερη φωτεινότητα από τη συνιστώμενη φωτεινότητα που περιγράφεται στο Εγχειρίδιο Χρήστη,
- (στ) Τυχόν ελάττωμα του Προϊόντος που προκαλείται από εξωτερικό εξοπλισμό,
- (ζ) Τυχόν ελάττωμα του Προϊόντος στο οποίο έχει τροποποιηθεί ή αφαιρεθεί ο γνήσιος αριθμός σειράς,
- (η) Τυχόν φυσιολογική φθορά του προϊόντος, ιδιαίτερα αυτής των αναλώσιμων, των αξεσουάρ ή/και των προσαρτημάτων (π.χ. κουμπιά, περιστρεφόμενα μέρη, καλώδια, Εγχειρίδιο Χρήστη, κτλ.), και
- (θ) Τυχόν παραμόρφωση, αποχρωματισμό ή/και διαστρέβλωση του εξωτερικού μέρους του προϊόντος, περιλαμβανομένης της επιφάνειας της οθόνης LCD.

Ο Αρχικός Αγοραστής για να δικαιούται υπηρεσίες επισκευής σύμφωνα με την Εγγύηση, θα πρέπει να παραδώσει το Προϊόν, με πληρωμένα τα μεταφορικά έξοδα, στην αρχική του συσκευασία ή σε άλλη επαρκή συσκευασία με ισότιμο βαθμό προστασίας, αναλαμβάνοντας τον κίνδυνο βλάβης ή/και απώλειας κατά τη μεταφορά, στον τοπικό Διανομέα. Ο Αρχικός Αγοραστής όταν ζητά υπηρεσίες επισκευής σύμφωνα με την Εγγύηση, θα πρέπει να προσκομίζει την απόδειξη αγοράς του Προϊόντος και την ημερομηνία της αγοράς.

Η Περίοδος Εγγύησης για οποιοδήποτε αντικατεστημένο ή/και επισκευασμένο προϊόν σύμφωνα με την παρούσα Εγγύηση λήγει στο τέλος της αρχικής Περιόδου Εγγύησης.

Η ΕΙΖΟ Ή ΟΙ ΔΙΑΝΟΜΕΙΣ ΔΕΝ ΕΥΘΥΝΟΝΤΑΙ ΓΙΑ ΟΠΟΙΟΔΗΠΟΤΕ ΒΛΑΒΗ Ή ΑΠΩΛΕΙΑ ΔΕΔΟΜΕΝΩΝ Ή ΑΛΛΩΝ ΠΛΗΡΟΦΟΡΙΩΝ ΠΟΥ ΑΠΟΘΗΚΕΥΟΝΤΑΙ ΣΕ ΟΠΟΙΟΔΗΠΟΤΕ ΜΕΣΟ Ή ΟΠΟΙΟΔΗΠΟΤΕ ΑΛΛΟ ΜΕΡΟΣ ΣΕ ΟΠΟΙΟΔΗΠΟΤΕ ΠΡΟΪΟΝ ΠΟΥ ΕΠΙΣΤΡΕΦΕΤΑΙ ΣΤΗΝ ΕΙΖΟ Ή ΣΕ ΔΙΑΝΟΜΕΑ ΓΙΑ ΕΠΙΣΚΕΥΗ.

Η ΕΙΖΟ ΚΑΙ ΟΙ ΔΙΑΝΟΜΕΙΣ ΔΕΝ ΠΑΡΕΧΟΥΝ ΚΑΜΙΑ ΠΕΡΑΙΤΕΡΩ ΕΓΓΥΗΣΗ, ΡΗΤΗ Ή ΣΥΝΕΠΑΓΟΜΕΝΗ, ΟΣΟΝ ΑΦΟΡΑ ΤΟ ΠΡΟΪΟΝ ΚΑΙ ΤΗΝ ΠΟΙΟΤΗΤΑ, ΤΗΝ ΑΠΟΔΟΣΗ, ΤΗΝ ΕΜΠΟΡΕΥΣΙΜΟΤΗΤΑ Ή ΤΗΝ ΚΑΤΑΛΛΗΛΟΤΗΤΑ ΤΟΥ ΓΙΑ ΟΠΟΙΟΔΗΠΟΤΕ ΣΥΓΚΕΚΡΙΜΕΝΗ ΧΡΗΣΗ. ΣΕ ΚΑΜΙΑ ΠΕΡΙΠΤΩΣΗ Η ΕΙΖΟ Ή ΟΙ ΔΙΑΝΟΜΕΙΣ ΔΕΝ ΘΑ ΕΥΘΥΝΟΝΤΑΙ ΓΙΑ ΚΑΜΙΑ ΑΠΟΛΥΤΩΣ ΤΥΧΑΙΑ, ΕΜΜΕΣΗ, ΕΙΔΙΚΗ, ΣΥΝΕΠΑΓΟΜΕΝΗ Ή ΑΛΛΗ ΒΛΑΒΗ (ΠΕΡΙΛΑΜΒΑΝΟΜΕΝΩΝ, ΜΕΤΑΞΥ ΑΛΛΩΝ, ΒΛΑΒΩΝ Ή ΑΠΩΛΕΙΑΣ ΚΕΡΔΩΝ, ΔΙΑΚΟΠΗΣ ΕΠΙΧΕΙΡΗΜΑΤΙΚΩΝ ΔΡΑΣΤΗΡΙΟΤΗΤΩΝ, ΑΠΩΛΕΙΑΣ ΕΠΙΧΕΙΡΗΜΑΤΙΚΩΝ ΠΛΗΡΟΦΟΡΙΩΝ Ή ΤΥΧΟΝ ΑΛΛΗΣ ΧΡΗΜΑΤΙΚΗΣ ΑΠΩΛΕΙΑΣ) ΠΟΥ ΠΡΟΚΥΠΤΕΙ ΑΠΟ ΤΗ ΧΡΗΣΗ Ή ΤΗΝ ΑΝΙΚΑΝΟΤΗΤΑ ΧΡΗΣΗΣ ΤΟΥ ΠΡΟΪΟΝΤΟΣ Ή ΤΥΧΟΝ ΑΛΛΗΣ ΣΥΝΔΕΣΗΣ ΜΕ ΤΟ ΠΡΟΪΟΝ, ΕΙΤΕ ΒΑΣΙΖΕΤΑΙ ΣΕ ΣΥΜΒΟΛΑΙΟ, ΒΛΑΒΗ, ΑΜΕΛΕΙΑ, ΑΥΣΤΗΡΗ ΕΥΘΥΝΗ Ή ΕΙΔΑΛΛΩΣ, ΑΚΟΜΗ ΚΙ ΕΑΝ Η ΕΙΖΟ Ή ΟΙ ΔΙΑΝΟΜΕΙΣ ΕΝΗΜΕΡΩΘΟΥΝ ΓΙΑ ΤΗΝ ΠΙΘΑΝΟΤΗΤΑ ΤΕΤΟΙΩΝ ΖΗΜΙΩΝ. Η ΕΞΑΙΡΕΣΗ ΑΥΤΗ ΠΕΡΙΛΑΜΒΑΝΕΙ ΕΠΙΣΗΣ ΟΠΟΙΟΔΗΠΟΤΕ ΕΥΘΥΝΗ ΕΝΔΕΧΕΤΑΙ ΝΑ ΠΡΟΚΥΨΕΙ ΑΠΟ ΑΞΙΩΣΕΙΣ ΤΡΙΤΟΥ ΜΕΡΟΥΣ ΚΑΤΑ ΤΟΥ ΑΡΧΙΚΟΥ ΑΓΟΡΑΣΤΗ. Η ΟΥΣΙΑ ΤΟΥ ΟΡΟΥ ΑΥΤΟΥ ΕΙΝΑΙ ΝΑ ΠΕΡΙΟΡΙΣΕΙ ΤΗΝ ΠΙΘΑΝΗ ΕΥΘΥΝΗ ΤΗΣ ΕΙΖΟ ΚΑΙ ΤΩΝ ΔΙΑΝΟΜΕΩΝ ΠΟΥ ΠΡΟΚΥΠΤΕΙ ΑΠΟ ΤΗΝ ΠΑΡΟΥΣΑ ΕΓΓΥΗΣΗ Ή/ΚΑΙ ΤΙΣ ΠΩΛΗΣΕΙΣ.

## ОГРАНИЧЕННАЯ ГАРАНТИЯ

EIZO NANA CORPORATION (называемая в дальнейшем “EIZO”) и авторизованные EIZO дистрибуторы (называемые в дальнейшем “Дистрибуторы”) гарантируют, в соответствии с условиями и пунктами этой ограниченной гарантии (называемой в дальнейшем “Гарантия”), первичному покупателю (называемому в дальнейшем “Первоначальный покупатель”), который приобрел у EIZO или Дистрибуторов продукт, указанный в этом документе (называемый в дальнейшем “Продукт”), что EIZO или Дистрибуторы на свое усмотрение либо бесплатно отремонтируют, либо бесплатно заменят Продукт, если Первоначальный покупатель признает в пределах Гарантийного срока (определенного ниже), что (i) Продукт неисправен или он поврежден в процессе нормального использования Продукта в соответствии с описанием в инструкции по эксплуатации, прилагаемой к Продукту (называемой в дальнейшем “Руководство пользователя”), или что (ii) панель ЖКД и Яркость Продукта не в состоянии поддерживать рекомендованную яркость, указанную в Руководстве пользователя при условии нормального использования Продукта в соответствии с описанием в Руководстве пользователя.

Гарантийный период ограничен сроком пять (5) лет от даты приобретения Продукта при условии, что время использования не превышает 30 000 часов (называемый в дальнейшем “Гарантийный период”) с условием, что Гарантийный период для панели ЖКД ограничен сроком три (3) года от даты приобретения Продукта. Яркость Продукта может быть гарантирована только, если Продукт использовался с рекомендованной яркостью, указанной в Пособии Пользователя и гарантийный период для яркости ограничен сроком три (3) года от даты приобретения продукта и время его использования не превышает 10 000 часов. EIZO и Дистрибуторы не несут никакой ответственности и не берут обязательств относительно Продукта по отношению к Первоначальному покупателю или по отношению к любым третьим сторонам, кроме обязательств, оговоренных в этой Гарантии.

EIZO и Дистрибуторы прекратят хранение или складирование любых деталей Продукта по истечении семи (7) лет после прекращения производства таких деталей. В случае ремонта монитора EIZO и Дистрибуторы будут использовать запчасти, которые соответствуют нашим стандартам QC (контроль качества).

Гарантия действительна только в странах или регионах, где расположены Дистрибуторы. Гарантия не ограничивает никакие законные права Первоначального покупателя.

Несмотря на другие условия этой Гарантии EIZO и Дистрибуторы не несут никаких обязательств согласно этой Гарантии в любом из перечисленных ниже случаев:

- (а) Любые дефекты Продукта, вызванные повреждениями при перевозке, модификацией, изменением, неправильным обращением, неправильным использованием, авариями, неправильной установкой, стихийными бедствиями, неправильным уходом и/или неправильным ремонтом третьей стороной, отличной от EIZO или Дистрибуторов;
- (б) Любые несовместимости Продукта из-за технических усовершенствований и/или изменения технических норм;
- (в) Любое повреждение датчика;
- (г) Любые ухудшения работы дисплея, вызванные изнашиванием невосстановимых частей, таких как панель ЖКД и/или подсветка и т.д. (например, изменение в равномерности яркости, изменение в цветности, изменение в равномерности цветности, изменение в пикселях, включая выгоревшие пиксели и т.д.);
- (д) Любые ухудшения Продукта, вызванные использованием при яркости, повышенной по сравнению с рекомендованной яркостью, описанной в Руководстве пользователя;
- (е) Любые дефекты Продукта, вызванные внешним оборудованием;
- (ж) Любые дефекты Продукта, при которых оригинальный серийный номер был изменен или удален;
- (з) Любые естественные ухудшения продукта, в частности, вызванные износом расходных частей, принадлежностей и/или приспособлений (например, кнопок, вращающихся частей, кабелей, Руководства пользователя и т.д.); и
- (и) Любые деформации, изменения цвета и/или коробления внешней поверхности продукта, включая поверхность панели ЖКД.

Чтобы получить техническое обслуживание в рамках Гарантии, Первоначальный покупатель должен доставить Продукт местному Дистрибутору, оплатив перевозку, в его оригинальной упаковке или в другой соответствующей упаковке, обеспечивающей равноценную степень защиты, принимая во внимание риск повреждения и/или утерю при транспортировке. При запросе технического обслуживания в рамках Гарантии Первоначальный покупатель должен предоставить свидетельство покупки продукта и даты покупки.

Гарантийный период для любого замененного и/или отремонтированного продукта в рамках Гарантии истекает в конце завершения срока действия оригинального Гарантийного периода.

**EIZO ИЛИ ДИСТРИБУТОРЫ НЕ НЕСУТ ОТВЕТСТВЕННОСТИ ЗА ЛЮБЫЕ ПОВРЕЖДЕНИЯ ИЛИ УТЕРЮ ДАННЫХ ИЛИ ДРУГОЙ ИНФОРМАЦИИ, ХРАНЯЩИХСЯ НА КАКИХ-ЛИБО НОСИТЕЛЯХ ИНФОРМАЦИИ ИЛИ НА ЛЮБЫХ ДРУГИХ ЧАСТЯХ ПРОДУКТА, КОТОРЫЙ ВОЗВРАЩЕН EIZO ИЛИ ДИСТРИБУТОРАМ ДЛЯ РЕМОНТА.**

**EIZO И ДИСТРИБУТОРЫ НЕ ДАЮТ НИКАКОЙ ДАЛЬНЕЙШЕЙ ГАРАНТИИ, ВЫРАЖЕННОЙ ИЛИ ПОДРАЗУМЕВАЕМОЙ, ОТНОСИТЕЛЬНО ПРОДУКТА И ЕГО КАЧЕСТВА, ТЕХНИЧЕСКИХ ХАРАКТЕРИСТИК, ТОВАРНОСТИ ИЛИ СООТВЕТСТВИЯ ДЛЯ КАКОГО-ЛИБО ОПРЕДЕЛЕННОГО ИСПОЛЬЗОВАНИЯ. НИ ПРИ КАКИХ УСЛОВИЯХ EIZO ИЛИ ДИСТРИБУТОРЫ НЕ НЕСУТ ОТВЕТСТВЕННОСТИ ЗА ЛЮБОЙ СЛУЧАЙНЫЙ, КОСВЕННЫЙ, СПЕЦИАЛЬНЫЙ, ПОБОЧНЫЙ ИЛИ ИНОЙ УЩЕРБ (ВКЛЮЧАЯ, БЕЗ ОГРАНИЧЕНИЙ, УЩЕРБ ИЗ-ЗА НЕПОЛУЧЕННОЙ ПРИБЫЛИ, ПРЕРЫВАНИЯ БИЗНЕСА, ПОТЕРИ КОММЕРЧЕСКОЙ ИНФОРМАЦИИ ИЛИ ЛЮБЫЕ ДРУГИЕ ФИНАНСОВЫЕ ПОТЕРИ), ВОЗНИКШИЙ ИЗ-ЗА ИСПОЛЬЗОВАНИЯ ИЛИ НЕВОЗМОЖНОСТИ ИСПОЛЬЗОВАТЬ ПРОДУКТ ИЛИ В ЛЮБОЙ ДРУГОЙ СВЯЗИ С ПРОДУКТОМ, ЛИБО ОСНОВАННЫЙ НА КОНТРАКТНЫХ ОТНОШЕНИЯХ, ГРАЖДАНСКИХ ПРАВОНАРУШЕНИЯХ, НЕБРЕЖНОСТИ, ПРИЧИНЕНИЯ УЩЕРБА ТРЕТЬЕЙ СТОРОНЕ ИЛИ ЧЕМ-ЛИБО ЕЩЕ, ДАЖЕ ЕСЛИ EIZO ИЛИ ДИСТРИБУТОРЫ БЫЛИ УВЕДОМЛЕНЫ О ВОЗМОЖНОСТИ ТАКОГО УЩЕРБА. ЭТО ИСКЛЮЧЕНИЕ ТАКЖЕ ВКЛЮЧАЕТ ЛЮБЫЕ ОБЯЗАТЕЛЬСТВА, КОТОРЫЕ МОГУТ ВОЗНИКНУТЬ В РЕЗУЛЬТАТЕ ТРЕБОВАНИЙ ТРЕТЬЕЙ СТОРОНЫ В ОТНОШЕНИИ ПЕРВОНАЧАЛЬНОГО ПОКУПАТЕЛЯ. СУЩЕСТВОМ ЭТОГО ПОЛОЖЕНИЯ ЯВЛЯЕТСЯ ОГРАНИЧЕНИЕ ПОТЕНЦИАЛЬНОЙ ОТВЕТСТВЕННОСТИ EIZO И ДИСТРИБУТОРОВ, ВОЗНИКАЮЩЕЙ ИЗ-ЗА ЭТОЙ ОГРАНИЧЕННОЙ ГАРАНТИИ И/ЛИ ПРОДАЖ.**

## 有限责任保证书

EIZO NANAO有限公司（以下简称“EIZO”）和EIZO授权的经销商（以下简称“经销商”），接受并依照本有限责任保证书（以下简称“保证书”）之条款，向从EIZO和经销商购买本文中规定产品（以下简称“产品”）的原买方（以下称“原买方”）提供保证：在保证期内（规定如下），如果原买方发现(i)按本产品所附使用说明书（以下简称“用户手册”）所述方式正常使用本产品过程中，本产品出现故障或损坏；或(ii)按用户手册所述方式正常使用本产品过程中，本产品的液晶显示屏(LCD)及亮度未能达到用户手册中所述的推荐亮度时，EIZO和经销商根据其独立的判断免费修理或更换该产品。

本保证期限定为本产品的使用时间在3万小时以下的条件下自购买本产品之日起的五（5）年（以下简称“保证期限”），但液晶显示屏（LCD）的保证期限定为自购买本产品之日起三（3）年的期间。仅当在用户手册中所述的推荐亮度条件下使用本产品时，才保证本产品的亮度，亮度的保证期限定为本产品的使用时间在1万小时以下的条件下自购买本产品之日起三(3)年。EIZO和经销商将不向原买方或任何第三方承担本保证书所规定之外的与本产品有关任何责任或义务。

本产品的任何部件停产七(7)年后，EIZO和经销商将不再保留或保管任何这类部件。维修显示器时，EIZO与经销商将使用符合我方质量控制标准的替换零件。

本保证书仅对于设有经销商的国家或地区有效。本保证书并不限定原买方的任何法律权利。

无论本保证书的任何其他条款如何规定，对于任何下列情况之一，EIZO和经销商将不承担本保证书规定责任：

- (a) 由于运输损害、改装、改动、滥用、误用、意外事故、错误安装、灾害、维护不善和/或由除EIZO和经销商以外的第三方进行不适当的修理造成本产品的任何故障。
- (b) 由于可能发生的技术变更和/或调整造成本产品的任何不兼容性。
- (c) 传感器的任何劣化；
- (d) 由于诸如液晶显示屏（LCD）和/或背景照明等消耗品部件的老化造成的任何显示性能低劣（如亮度均一性变化、色彩变化、色彩均一性变化、包括烧伤像素在内的像素缺陷等）。
- (e) 由于在比用户手册所推荐亮度更高的亮度下使用对本产品所造成的任何老化。
- (f) 因外部设备造成本产品的任何故障。
- (g) 因本产品的原序号被改变或消除造成本产品的任何故障。
- (h) 本产品的任何正常老化，尤其是消耗品、附件和/或附加装置（如按钮、旋转部件、电缆、用户手册等）、以及
- (i) 本产品表面包括液晶显示屏（LCD）表面的任何变形、变色和翘曲。

为了获得本保证书规定的服务，原买方必须使用原包装或其他具有同等保护程度的适当包装将本产品运送到当地的经销商，并且预付运费，承担运输中的损坏和/或损失的风险。要求提供本保证书规定的服务时，原买方必须提交购买本产品和标明此购买日期的证明。

按本保证书规定进行了更换和/或修理的任何产品的保证期限，将在原保证期限结束时终止。

在返回给EIZO和经销商进行修理后，任何产品的任何媒体或任何部件中储存的数据或其他信息发生任何损坏或损失，对此EIZO和经销商将不承担责任。

对于本产品及其质量、性能、可销售性以及对于特殊用途的适合性，EIZO和经销商不提供其他任何明示或暗示的保证。因使用本产品或无法使用本产品或因与本产品有任何关系（无论是否根据合同）而造成任何附带的、间接的、特殊的、随之发生的或其他的损害（包括但不限于：利润损失、业务中断、业务信息丢失或其他任何金钱损失）以及侵权行为、过失、严格赔偿责任或其他责任，即使已经向EIZO和经销商提出了发生这些损害的可能性，对此EIZO和经销商概不承担责任。本免责条款还包括因第三方向原买方提出索赔而可能发生的任何责任。本条款的本质是限定由于本有限责任保证书和/或销售本产品所发生的EIZO和经销商的潜在责任。



## 关于电子信息产品污染控制标识



本标识根据「电子信息产品污染控制管理办法」，适用于在中华人民共和国销售的电子信息产品。标识中央的数字为环保使用期限的年数。只要您遵守该产品相关的安全及使用注意事项，在自制造日起算的年限内，不会产生对环境污染或人体及财产的影响。上述标识粘贴在机器背面。

### • 有毒有害物质或元素的名称及含量

部件名称	有毒有害物质或元素					
	铅 (Pb)	汞 (Hg)	镉 (Cd)	六价铬 (Cr (VI))	多溴联苯 (PBB)	多溴二苯醚 (PBDE)
印刷电路板	×	○	○	○	○	○
机箱	○	○	○	○	○	○
液晶显示器	×	×	○	○	○	○
其他	×	○	○	○	○	○
○: 表示该有毒有害物质在该部件所有均质材料中的含量均在SJ/T 11363-2006规定的限量要求以下。 ×: 表示该有毒有害物质至少在该部件的某一均质材料中的含量超出SJ/T 11363-2006规定的限量要求。(企业可在此处,根据实际情况对上表中打“×”的技术原因进行进一步说明)						



**EIZO NANA O CORPORATION**

153 Shimokashiwano, Hakusan, Ishikawa 924-8566 Japan  
Phone: +81 76 277 6792 Fax: +81 76 277 6793

**EIZO EUROPE AB**

Lovangsvagen 14 194 61, Upplands Väsby, Sweden  
Phone: +46 8 594 105 00 Fax: +46 8 590 91 575

<http://www.eizo.com>

1st Edition-February, 2010

03V23044A1  
(U.M-CG245W)