

User's Manual

ColorEdge® **PROMINENCE** **CG3145** HDR Reference Monitor

Thank you for purchasing our HDR reference monitor.

Important

Please read this “User’s Manual”, and “PRECAUTIONS” (separate volume) carefully to familiarize yourself with safe and effective usage.

-
- Refer to the “Setup Guide” for information on the installation / connection of the monitor.
 - For the latest product information including the “User’s Manual” and drivers, refer to our web site:

www.eizoglobal.com



Location of Caution Statement

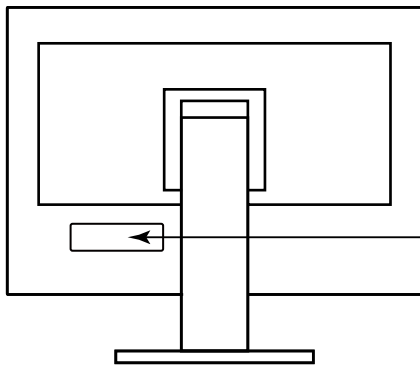

WARNING
RISK OF ELECTRIC SHOCK. DO NOT OPEN.
AVERTISSEMENT
RISQUE DE CHOC ÉLECTRIQUE. NE PAS OUVRIR.
WARNUNG
GEFAHR DES ELEKTRISCHEN SCHLAGES. RÜCKWAND NICHT ENTFERNEN.
警告
触电危険，请勿打开后盖。
警告
感電の恐れあり，カバーをあけないでください。

The equipment must be connected to a grounded main outlet.
L'appareil doit être relié à une prise avec terre.
Jordet stikkontakt skal benyttes når apparatet tilkobles datanett.
Apparaten skall anslutas till jordat nätuttag.
设备必须连接到接地地的电源插座。
電源コードのアースは必ず接地してください。

This product has been adjusted specifically for use in the region to which it was originally shipped. If operated outside this region, the product may not perform as stated in the specifications.

No part of this manual may be reproduced, stored in a retrieval system, or transmitted, in any form or by any means, electronic, mechanical, or otherwise, without the prior written permission of EIZO Corporation. EIZO Corporation is under no obligation to hold any submitted material or information confidential unless prior arrangements are made pursuant to EIZO Corporation's receipt of said information. Although every effort has been made to ensure that this manual provides up-to-date information, please note that EIZO monitor specifications are subject to change without notice.

Notice for This Monitor

About the Usage of This Product

This product is suited for producing videos, where accurate color reproduction is a priority.

This product has been adjusted specifically for use in the region to which it was originally shipped. If the product is used outside the region, it may not operate as specified in the specifications.

This product may not be covered by warranty for uses other than those described in this manual.

The specifications noted in this manual are only applicable when the following are used:

- Power cords provided with the product
 - Signal cables specified by us
-

Only use optional products manufactured or specified by us with this product.

About the LCD Panel

The LCD panel is manufactured using high-precision technology. Although, missing pixels or lit pixels may appear on the LCD panel, this is not a malfunction. Percentage of effective dots: 99.9994 % or higher.

It takes about 30 minutes (under our measurement conditions) for the monitor display to stabilize. Please wait 30 minutes or more after the monitor power has been turned on, and then adjust the monitor.

If you switch SDR color modes and HDR color modes, wait 30 minutes or more after switching the color modes, and then adjust the monitor.

Monitors should be set to a lower brightness to reduce changes in luminosity caused by long-term use and maintain a stable display.

When the screen image is changed after displaying the same image for extended periods of time, an afterimage may appear. Use the screen saver or power save function to avoid displaying the same image for extended periods of time. Depending on the image, an afterimage may appear even if it was displayed for a short period of time. To remove such a phenomenon, change the image or keep the power turned off for several hours.

If the monitor displays continuously over a long period of time, smudges or burn-in may appear. To maximize the life of the monitor, we recommend the monitor be turned off periodically. Use the power button on the front of the monitor to turn it off.

The backlight of the LCD panel has a fixed lifetime. Depending on the usage pattern, such as usage for long continuous periods, the lifespan of the backlight may run out sooner, requiring replacement. When the screen becomes dark or begins to flicker, please contact your local EIZO representative.

Do not press on the LCD panel or edge of the frame strongly, as this may result in display malfunctions, such as interference patterns, etc. If pressure is continuously applied to the LCD panel surface, the liquid crystal may deteriorate or the LCD panel may be damaged. (If the pressure marks remain on the panel, leave the monitor with a black or white screen. The symptom may disappear.)

Do not scratch or press on the LCD panel with any sharp objects, as this may result in damage to the LCD panel. Do not attempt to brush with tissues as this may scratch the panel.

About the Installation

When the monitor is cold and brought into a room or the room temperature goes up quickly, dew condensation may occur on the interior and exterior surfaces of the monitor. In that case, do not turn the monitor on. Instead wait until the dew condensation disappears, otherwise it may cause some damage to the monitor.

If you place this product on a lacquer-coated desk, the color may adhere to the bottom of the stand due to the composition of the rubber. Check the desk surface before use.

About the Maintenance

Periodic cleaning is recommended to keep the monitor looking new and to prolong its operation lifetime (refer to “Cleaning” (page 4)).

Update program for the internal software (firmware) of the monitor may be provided to improve the performance of monitor and other purposes. Select “Software and Drivers” in “Support” from our web site (www.eizoglobal.com), enter the product name, and perform search.

Cleaning

The stains on the cabinet and LCD panel surface can be removed by using the provided ScreenCleaner.

Attention

- Chemicals such as alcohol and antiseptic solution may cause gloss variation, tarnishing, and fading of the cabinet or LCD panel, and also quality deterioration of the image.
 - Never use thinner, benzene, wax, or abrasive cleaner as they may damage the cabinet or LCD panel surface.
-

To Use the Monitor Comfortably

- An excessively dark or bright screen may affect your eyes. Adjust the brightness of the monitor according to the environmental conditions.
- Staring at the monitor for a long time tires your eyes. Take a 10-minute rest every hour.

Contents

Notice for This Monitor	3	Chapter 6 SDR/HDR Settings	35
Cleaning	4	6-1. About Each Color Mode	35
To Use the Monitor Comfortably	4	● Types and Applications of Color Modes for Image Creation	35
Contents	5	● BT.2020	36
Chapter 1 Introduction	6	● BT.709	37
1-1. Features	6	● DCI	38
● Large built-in high resolution 4K LCD that is advantageous for video production	6	● PQ_BT.2100.....	39
● Support for HDR (High Dynamic Range) video.....	6	● PQ_BT.709.....	40
● Various functions that support color grading work.....	7	● PQ_DCI.....	41
● Equipped with a USB Hub function.....	7	● HLG_BT.2100.....	42
1-2. Controls and Functions	8	6-2. Setting Procedure	43
● Front	8	● List of Setting Items.....	46
● Rear.....	9	6-3. Settings with ColorNavigator 7	47
Chapter 2 Basic Adjustments/Settings	10	● Setting Procedure	47
2-1. Button Operation Method	10	● Target Settings of ColorNavigator 7.....	48
● Operation Guide Icons	10	Chapter 7 Calibration	50
2-2. Switching Input Signals	11	Chapter 8 Troubleshooting	51
2-3. Switching the Display Mode (color mode)	11	8-1. No Picture	51
● Display Modes.....	11	8-2. Imaging Problems	52
● Color Mode Setting Values	12	8-3. Other Problems	53
Chapter 3 Advanced Adjustments/ Settings	13	Chapter 9 Reference	54
3-1. Basic Operation of the Setting Menu	13	9-1. Connecting Multiple External Devices	54
3-2. Setting Menu Functions	14	9-2. Making Use of the USB Hub Function	55
● Signal	14	● Required System Environment	55
● Color.....	16	● Connection Procedure (Setup of USB Function).....	56
● Screen.....	22	9-3. Specifications	57
● Preferences.....	26	● Accessories.....	58
● Languages	28	Appendix	59
● Information	28	Trademark	59
Chapter 4 Custom Key Settings	29	License	59
4-1. Basic Operation of the Custom Keys	29	FCC Declaration of Conformity	60
4-2. Assigning a Function to a Custom Key	29		
● Functions that can be Assigned to Custom Keys	31		
Chapter 5 Administrator Settings	32		
5-1. Basic Operation of the "Administrator Settings" Menu	32		
5-2. "Administrator Settings" Menu Functions	33		

Chapter 1 Introduction

This chapter describes the features of the monitor and the name of each control.

1-1. Features

● Large built-in high resolution 4K LCD that is advantageous for video production

- 31.1-inch widescreen monitor with support for DCI 4K resolution (4096 × 2160)
Supports the digital cinema standard for DCI 4K resolution of 4096 × 2160. In addition to 4K videos, which have a high resolution that is more than 4x greater than full HD, multiple full HD videos can be displayed at the same time.
- Faithful reproduction of video colors with a wide color gamut display
99 % of DCI is covered, for a highly accurate color management environment.
- Achieves a contrast ratio of 1,000,000:1^{*1}
A high contrast ratio allows black to be displayed in a firmer tone.
^{*1} Standard value. Not a guaranteed value.
- Built-in IPS LCD panel with 178° horizontal and vertical wide viewing angles

● Support for HDR (High Dynamic Range) video

- Complies with the international HDR standards for movies and broadcasts
Supports both the HDR "PQ format" for streaming and movie production, and the HDR "Hybrid Log Gamma format" for broadcasts. The "PQ format" complies with the ITU-R BT.2100^{*2} and SMPTE ST2084^{*3} international HDR standards, and the "Hybrid Log Gamma format" complies with the ITU-R BT.2100 international HDR standard. This makes it possible to use the monitor for the color grading of a wide range of HDR content, such as movies and broadcasts.
^{*2} ITU-R is the International Telecommunication Union-Radio communication Sector.
^{*3} SMPTE is the Society of Motion Picture and Television Engineers.
- High brightness and high contrast ratio
High brightness and a high contrast ratio are achieved by installing a dedicated IPS LCD panel and a dedicated backlight unit with a high level of brightness.
- Built-in color mode function
Reproduces a color temperature, gamma, and color gamut compliant with ITU-R BT.2100 and other standards.
See ["Color Mode" \(page 16\)](#).

● Various functions that support color grading work

- Dedicated video production functions, such as a Gamut Warning function and a Luminance Warning function
See [“Chapter 3 Advanced Adjustments/Settings” \(page 13\)](#).
- 4K Zoom function
When a 4K2K signal (a signal with a resolution of 4096 × 2160 or 3840 × 2160) is displayed on the monitor, the specified area can be doubled in size. This is convenient for checking details in an image.
See [“Zoom” \(page 23\)](#).
- User-defined custom key function
Work efficiency can be improved by assigning frequently used functions to the buttons on the front of the monitor.
See [“Chapter 4 Custom Key Settings” \(page 29\)](#).
- Supports the "ColorNavigator NX" color management software
Use ColorNavigator NX to adjust the display according to various video production standards. Since adjustment results are assigned to each color mode in the monitor, the display can be switched with the buttons on the front of the monitor for easy color management.
See [“Chapter 7 Calibration” \(page 50\)](#).
- Displays HDCP (High Bandwidth Digital Protection) protected content
- Monitor hood included as standard
Includes a monitor hood that effectively prevents reflections from external light, such as the reflected glare of a light. The monitor hood uses magnets for easy attachment and removal.

● Equipped with a USB Hub function

- Supports USB 3.0
Achieves high-speed data transfers of up to 5 Gbps, which enables transfers of large amounts of data to and from USB memory devices in a short amount time.
Also, the  USB downstream port supports quick charging, so you can recharge your smartphone or tablet in a short period of time.
See [“9-2. Making Use of the USB Hub Function” \(page 55\)](#) and [“USB CHARGE Port” \(page 26\)](#).

1-2. Controls and Functions

● Front

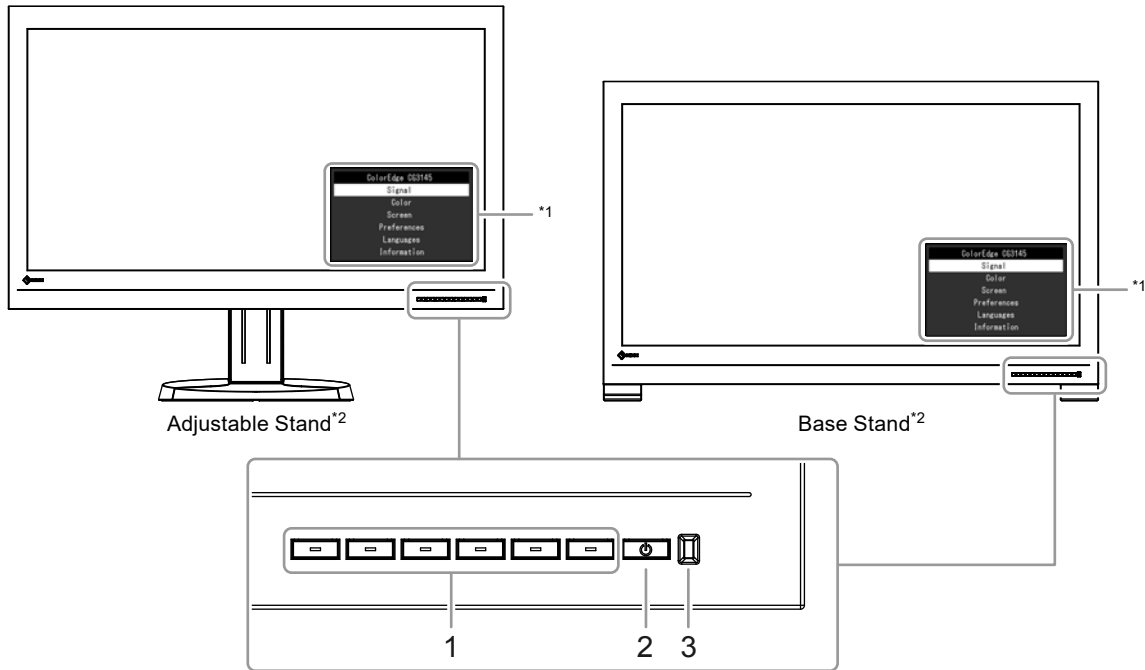

1. Control buttons	Displays menus. Operate the buttons according to the operation guide.
2. Power button	Turns the power on or off.
3. Power indicator	<p>The indicator is lit when you turn the power on. The indicator color differs depending on the monitor's operation status.</p> <p>Blue : Operating Orange : Power saving mode OFF : Power off</p>

*1 See “3-1. Basic Operation of the Setting Menu” (page 13) for more information about how to use the Setting menu.

*2 This manual uses the figures for the Adjustable Stand if the descriptions are common to both stands.

● Rear

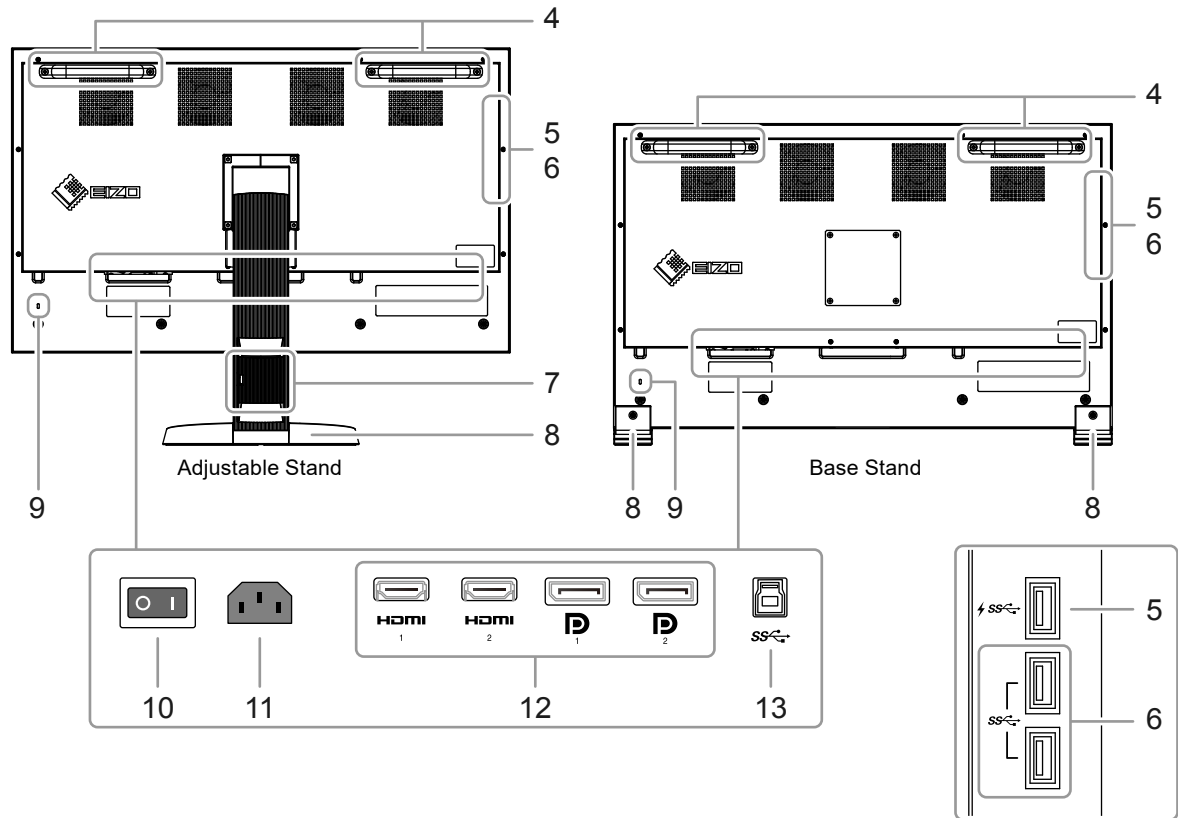

4. Handle	This handle is used for transportation. Attention <ul style="list-style-type: none"> With help from one other person, firmly grasp and hold the monitor by the bottom while grabbing the handle, and carefully convey the monitor so as not to drop it.
5. USB downstream port (supports quick charging)	Connects to a peripheral USB device (page 26).
6. USB downstream port	Connects to a peripheral USB device.
7. Cable holder	Covers the monitor cables (Adjustable Stand only).
8. Stand	Adjustable Stand : The height and angle (swivel) of the monitor are adjustable. Base Stand : The height and angle are not adjustable.
9. Security lock slot	Complies with Kensington's MicroSaver security system.
10. Main power switch	Turns the main power on or off. : On ○: Off Normally, it is not necessary to turn off the main power switch.
11. Power connector	Connects the power cord.
12. Input signal connectors	The following input connectors are located on the monitor rear in order of left to right. HDMI connector 1 HDMI connector 2 DisplayPort connector 1 DisplayPort connector 2
13. USB upstream port	Connects to the USB cable when using software that requires a USB connection, or when using the USB Hub function (page 55).

Chapter 2 Basic Adjustments/Settings

This chapter describes the basic functions that can be set by pressing the buttons on the front of the monitor. For advanced adjustment and setting procedures using the Setting menu, see “Chapter 3 Advanced Adjustments/Settings” (page 13).

2-1. Button Operation Method

1. Displaying the operation guide

1. Press any of the buttons (except ).
The operation guide appears on the screen.



2. Setting

1. Press the button for an item that you want to set.
The Setting menu appears.
2. Use the buttons to adjust/set the selected item, and then select  to confirm.









3. Exiting

1. Select  to exit the menu.

Note

- The contents of the guide will differ depending on the selected menu or status.

● Operation Guide Icons

Icon	Description
	Switches the input signal.
	Switches the color mode.
	Executes the function assigned to Custom Key 1.
	Executes the function assigned to Custom Key 2.
	Displays the Setting menu.
	Returns to the previous screen.
	Moves the cursor.
	Executes the selected operation.
	Turns the monitor's power on or off.

2-2. Switching Input Signals

When a monitor has multiple signal inputs, the signal to display on-screen can be changed.

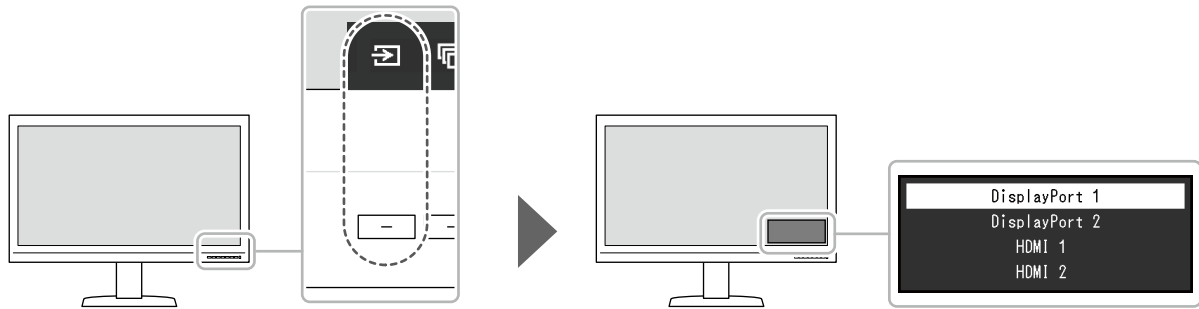

2-3. Switching the Display Mode (color mode)

This function allows easy selection of a display mode according to monitor application.

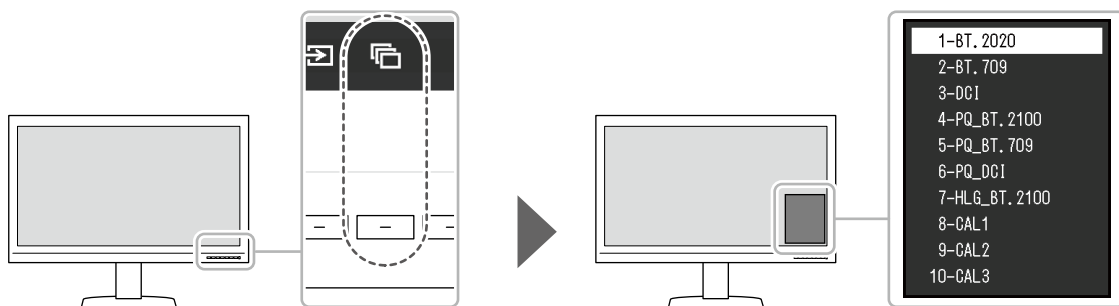

● Display Modes

Color Mode	Purpose
Standard Mode	Adjust color using the monitor's Setting menu.
BT.2020	See "Color Mode Setting Values" (page 12) for detailed setting values for each color mode.
BT.709	
DCI	
PQ_BT.2100	
PQ_BT.709	
PQ_DCI	
HLG_BT.2100	
Calibration Mode (CAL mode)	This mode displays the screen according to the settings that you have adjusted with the "ColorNavigator NX" color management software.
CAL1	Displays the screen adjusted by ColorNavigator NX.
CAL2	
CAL3	

Note

- If you switch SDR color modes (BT.2020, BT.709, and DCI) and HDR color modes (PQ_BT.2100, PQ_BT.709, PQ_DCI, and HLG_BT.2100), wait 30 minutes or more after switching the color modes, and then adjust the monitor.

● Color Mode Setting Values

-: Cannot be changed

Item	Color Mode									
	BT.2020	BT.709	DCI	PQ_ BT.2100	PQ_ BT.709	PQ_ DCI	HLG_ BT.2100	CAL1 / CAL2 / CAL3		
Brightness (cd/m ²)	100	100	48	1000	1000	1000	1000	-		
Temperature	D65	D65	D65	D65	D65	D65	D65	-		
Gamma (EOTF)	2.4	2.4	2.6	PQ	PQ	PQ	HLG	-		
PQ Clipping (cd/m ²)	-	-	-	1000	1000	1000	-	-		
HLG System Gamma	-	-	-	-	-	-	1.2	-		
Color Gamut	BT.2020	BT.709	DCI	BT.2020	BT.709	DCI	BT.2020	-		
Advanced Settings	Hue	0	0	0	0	0	0	-		
	Saturation	0	0	0	0	0	0	-		
	Gamut Clipping	On	Off	Off	On	Off	Off	On		
	XYZ Format	-	-	Off	-	-	Off	-		
	Gain	Red	Calculated from color temperature						-	
		Green							-	
		Blue							-	
	Black Level	All	0	0	0	0	0	0	-	
		Red	0	0	0	0	0	0	-	
		Green	0	0	0	0	0	0	-	
		Blue	0	0	0	0	0	0	-	
	6 Colors	Magenta	Hue	0	0	0	0	0	0	-
			Saturation	0	0	0	0	0	0	-
			Lightness	0	0	0	0	0	0	-
		Red	Hue	0	0	0	0	0	0	-
			Saturation	0	0	0	0	0	0	-
Lightness			0	0	0	0	0	0	-	
Yellow		Hue	0	0	0	0	0	0	-	
		Saturation	0	0	0	0	0	0	-	
		Lightness	0	0	0	0	0	0	-	
Green		Hue	0	0	0	0	0	0	-	
		Saturation	0	0	0	0	0	0	-	
		Lightness	0	0	0	0	0	0	-	
Cyan	Hue	0	0	0	0	0	0	-		
	Saturation	0	0	0	0	0	0	-		
	Lightness	0	0	0	0	0	0	-		
Blue	Hue	0	0	0	0	0	0	-		
	Saturation	0	0	0	0	0	0	-		
	Lightness	0	0	0	0	0	0	-		

Note

- Use ColorNavigator NX to set CAL1 / CAL2 / CAL3. These settings cannot be changed in the Setting menu on the monitor.
- A color mode can be set for each input signal.
- See “Color” (page 16) for details about each item.
- You can disable specific mode selections. For more information, see “Mode Skip” (page 27).

Chapter 3 Advanced Adjustments/Settings

This chapter describes the advanced monitor adjustment and setting procedures using the Setting menu. For the basic setting functions using the buttons on the front of the monitor, see "Chapter 2 Basic Adjustments/Settings" (page 10).

3-1. Basic Operation of the Setting Menu

1. Menu display



1. Press any of the buttons (except ).
The operation guide appears.

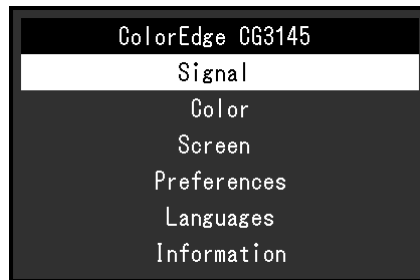

2. Select  .
The Setting menu appears.



2. Adjusting/setting

1. Choose a menu to adjust/set with   , and then select  .
The Sub menu appears.

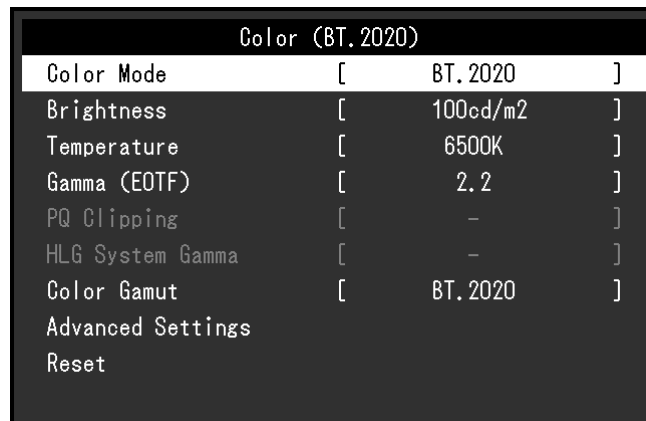

- Choose an item to adjust/set with **▲ ▼**, and then press **✓**.
The Adjustment/Setting menu appears.



- Adjust/set the selected item with **< >**, and then select **✓**.
The Sub menu appears.

Selecting **✕** during adjustment/setting will cancel the adjustment/setting and restore the state prior to making changes.

3. Exiting

- Select **✕**.
The Setting menu appears.
- Select **✕**.
The Setting menu exits.

Note

- The contents of the guide will differ depending on the selected menu or status.

3-2. Setting Menu Functions

● Signal

The signal settings are used to configure advanced settings for input signals, such as the screen display size and color format.

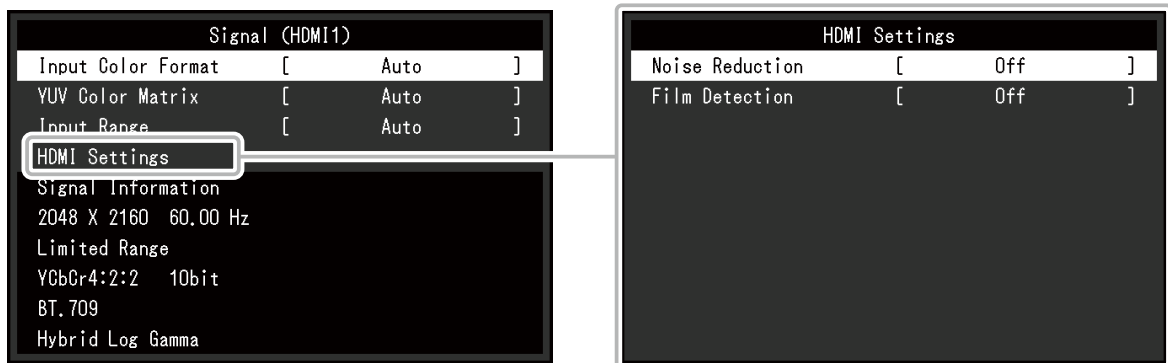

Function	Adjustable Range	Description
Input Color Format	Auto YUV 4:2:2*1 YUV 4:4:4*1 YUV*2 RGB	The color space of the input signal can be specified. Try changing this setting if colors are not displayed correctly. When inputting YUV 4:2:0, select "Auto".

*1 Only enabled during HDMI input

*2 Only enabled during DisplayPort input

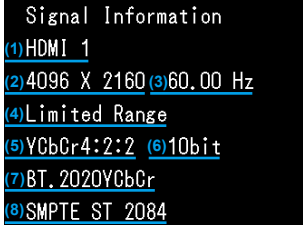
Function		Adjustable Range	Description
YUV Color Matrix		Auto BT.601 BT.709 BT.2020	Select the YUV format of the input signal. Use this setting for gradation collapse or other occurrences where the screen is displayed incorrectly because of a problem with the input signal.
Input Range		Auto Full Limited (109 % white) Limited SDI Full	<p>Depending on the external device, the black and white levels in the video signal output to the monitor may be restricted. If the signal is displayed on the monitor in its restricted form, the blacks will be faint, the whites dull, and contrast will be reduced. The brightness range of such signals can be extended to match the actual contrast ratio of the monitor.</p> <ul style="list-style-type: none"> "Auto" The monitor automatically recognizes the brightness range of input signals and displays images appropriately. "Full" The input signal brightness range is not extended. "Limited (109 % white)" The brightness range of the input signal is extended from 16 - 254 (10 bits: 64 - 1019) to 0 - 255 (10 bits: 0 - 1023) for display. "Limited" The brightness range of the input signal is extended from 16 - 235 (10 bits: 64 - 940) to 0 - 255 (10 bits: 0 - 1023) for display. "SDI Full" The brightness range of the input signal is extended from 1 - 254 (10 bits: 4 - 1019) to 0 - 255 (10 bits: 0 - 1023) for display.
HDMI Settings	Noise Reduction	On Off	<p>The small noises that occur in dark areas of an image are reduced. Use this function to reduce noise and roughness in images.</p> <p>Note</p> <ul style="list-style-type: none"> This can only be set when there is HDMI input. Using the Noise Reduction function may lead to deterioration of fine images.
	Film Detection	On Off	<p>When displaying an interlaced signal, a display method can be selected. For video, CG, animation, etc., the 24 fps or 30 fps signal is automatically detected, and the optimal image is displayed.</p> <p>Note</p> <ul style="list-style-type: none"> This can only be set when there is HDMI input. If the video does not display normally when "Film Detection" is set to "On", change the setting to "Off". "Film Detection" is enabled only when a 1080i signal is input.
Signal Information		-	<p>You can check the information for the input signal. The following information is displayed:</p>  <ul style="list-style-type: none"> (1) Signal Information (2) Resolution (3) Vertical Scan Frequency (4) Input Range (5) Color Format (6) Color Depth (7) Colorimetry (8) EOTF <p>"-" is displayed for the item without available information.</p> <p>Attention</p> <ul style="list-style-type: none"> When "SMPTE170M/BT.709" is displayed in "Signal Information" during HDMI input, signals from the outputting device may not be displayed properly. In such a case, try changing the settings for the outputting device or reconnecting the device using DisplayPort input.

● Color

The setting details differ depending on the color mode selected.

When the color mode is Standard Mode (BT.2020 / BT.709 / DCI / PQ_BT.2100 / PQ_BT.709 / PQ_DCI / HLG_BT.2100)

Each color mode setting status can be adjusted according to personal preference.

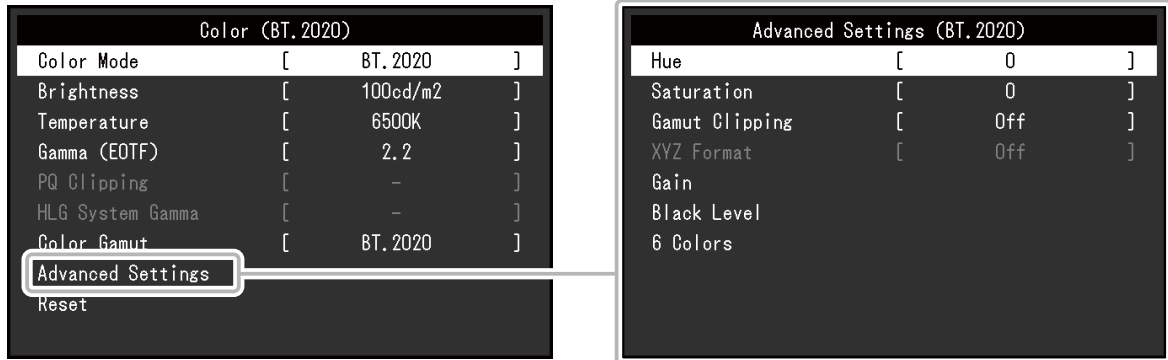

Attention

- The same image may be seen in different colors on multiple monitors due to differences between individual monitors. Make fine color adjustment visually when matching colors on multiple monitors.

Note

- Use the values shown in "cd/m²", "K", and "%" as a guide only.

Function	Adjustable Range	Description
Color Mode	BT.2020 BT.709 DCI PQ_BT.2100 PQ_BT.709 PQ_DCI HLG_BT.2100 CAL1 CAL2 CAL3	Switch to the desired mode according to the monitor application. Note <ul style="list-style-type: none"> • For more information on how to switch modes, see "2-3. Switching the Display Mode (color mode)" (page 11). • Regarding "CAL1 / CAL2 / CAL3" see page 21.
Brightness	48 cd/m ² to 1000 cd/m ²	The screen brightness is adjusted by changing the brightness of the backlight (light source from the LCD back panel). Note <ul style="list-style-type: none"> • If a value that cannot be set is selected, the value will appear in magenta. In such a case, change the value. • 48 cd/m² to 300 cd/m² can be set in increments of 1, and 300 cd/m² to 1000 cd/m² can be set in increments of 100.

Function	Adjustable Range	Description
Temperature	Native 4000 K to 10000 K D50 D65 DCI User	<p>The color temperature can be adjusted.</p> <p>The color temperature is used to express the chromaticity of "White". The value is expressed in degrees "K" (Kelvin).</p> <p>The screen becomes reddish at a low color temperature, and bluish at a high color temperature, like the temperature of a flame.</p> <p>Specify a color temperature in units of 100 K, or select a standard name.</p> <p>Note</p> <ul style="list-style-type: none"> • When you select "Native", the original color of the monitor (Gain: 100 % for each RGB) is displayed. • "Gain" allows you to perform more advanced adjustment. When gain is changed, the color temperature is changed to "User". • The gain preset values are set for each color temperature setting value.
Gamma (EOTF)	1.6 to 2.7 sRGB EBU(2.35) PQ HLG	<p>Adjust the gamma.</p> <p>The brightness of the monitor varies depending on the input signal, however, the variation rate is not simply proportional to the input signal. The control performed to keep the balance between the input signal and the brightness of the monitor is called "Gamma correction".</p> <p>Set the gamma, or select a standard name.</p> <p>Note</p> <ul style="list-style-type: none"> • If you select "HLG", you must set "HLG System Gamma".
PQ Clipping	300 cd/m ² 500 cd/m ² 1000 cd/m ² 4000 cd/m ² Off	<p>Areas with brightness equal to or greater than the value set here are displayed as clipping at this setting value for the PQ signal that is input to the monitor.</p> <ul style="list-style-type: none"> • 300 cd/m² Setting used to check the display of monitor with maximum brightness of 300 cd/m². Input video level of 637 (10 bits) or more is clipped. • 500 cd/m² Setting used to check the display of monitor with maximum brightness of 500 cd/m². Input video level of 693 (10 bits) or more is clipped. • 1000 cd/m² Set the brightness to 1000 cd/m² to display properly. Input video level of 770 (10 bits) or more is clipped. • 4000 cd/m² Setting with which the image is properly displayed when monitor brightness is set to 4000 cd/m². This setting is used for a temporarily check because this monitor cannot display 4000 cd/m². Input video level of 924 (10 bits) or more is clipped. • Off Setting with which the image is properly displayed when monitor brightness is set to 10000 cd/m². This setting is used for a temporarily check because this monitor cannot display 10000 cd/m². All the input video level areas are displayed without clipping. <p>Note</p> <ul style="list-style-type: none"> • This can be set when "PQ" is specified for "Gamma (EOTF)". • You can check the areas where clipping occurs. For more information, see "Luminance Warning" (page 24). • For relation between input and output for each setting, see "Setting and Display of PQ Clipping" (page 19).

Function	Adjustable Range	Description
HLG System Gamma	1.0 to 1.5	<p>Adjust the system gamma value for the HLG signal that is input to the monitor.</p> <p>Note</p> <ul style="list-style-type: none"> This can be set when "HLG" is specified for "Gamma (EOTF)".
Color Gamut	Native Adobe®RGB sRGB EBU BT.709 BT.2020 SMPTE-C DCI	<p>Set the color reproduction area (color gamut). "Color Gamut" is the range of colors that can be represented. Multiple standards are defined.</p> <p>Note</p> <ul style="list-style-type: none"> Select "Native", to display the original color gamut of the monitor. The method of displaying colors outside the monitor's displayable range within the defined color gamut can be set. For more information, see "Gamut Clipping" (page 20).

Setting and Display of PQ Clipping

This section describes relation between the setting and input signal of PQ clipping (10 bits: 0 - 1023) and the brightness displayed on the monitor.

Note

- This relation assumes that the input signal is full range (and that "Input Range" in "Signal" is set to "Full").

● PQ Clipping 300 cd/m², 500 cd/m², and 1000 cd/m²

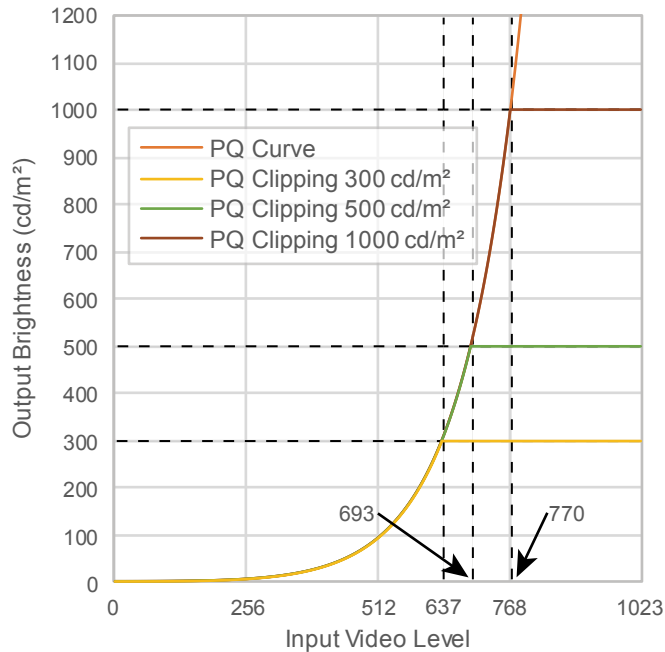

- Set the brightness to the specified value to display properly.

- Example: When PQ Clipping is set to 300 cd/m², set the monitor brightness to 300 cd/m².

● PQ Clipping 4000 cd/m² or Off (Monitor brightness setting: 1000 cd/m²)

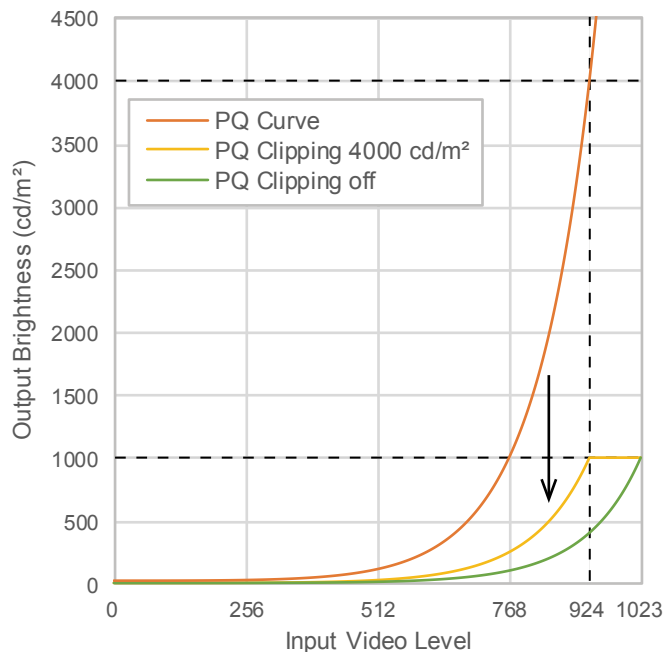

- This setting is used for a temporarily check.

- Example: When PQ Clipping is set to 4000 cd/m², the representation of gradation is equivalent to that of the monitor with the maximum brightness of 4000 cd/m². In this case, the representation of gradation is decreased according to the brightness setting of this monitor because it has the maximum brightness of 4000 cd/m² or less.

Function		Adjustable Range	Description
Advanced Settings	Hue	-100 to 100	<p>The hue can be adjusted.</p> <p>Note</p> <ul style="list-style-type: none"> Using this function may make some color gradations unavailable for display.
	Saturation	-100 to 100	<p>The saturation can be adjusted.</p> <p>Note</p> <ul style="list-style-type: none"> Using this function may make some color gradations unavailable for display. The minimum value (-100) changes the screen to monochrome.
	Gamut Clipping	On Off	<p>The method of displaying colors outside the monitor's displayable range within the color gamut specified in accordance with "Color Gamut" (page 18) can be set.</p> <ul style="list-style-type: none"> "On" <ul style="list-style-type: none"> The range of colors that are displayable on the monitor will be accurately displayed in accordance with the standard. Colors outside the displayable range will be saturated. "Off" <ul style="list-style-type: none"> Displays colors with priority on the color gradation rather than the color accuracy. The vertices of the color gamut defined in the standard move to a range that can be displayed by the monitor. This allows the closest colors displayable by the monitor to be displayed. <div style="border: 1px solid black; padding: 5px; margin: 10px 0;"> <p>— Color gamut displayable by the monitor</p> <p>— Color gamut defined by standard</p> <p>- - - Color gamut displayed on screen</p> </div> <p>Note</p> <ul style="list-style-type: none"> The diagrams shown above are conceptual diagrams, and they do not display the actual color gamut of the monitor. This setting will be disabled if "Native" is selected at "Color Gamut" (page 18).
	XYZ Format	On Off	<p>If this function is set to "On", the XYZ signal for digital cinema can be displayed on the monitor.</p> <p>Note</p> <ul style="list-style-type: none"> This can be set only when "Color Gamut" (page 18) is set to "DCI". If you select "On", you cannot set "Color Gamut".

Function		Adjustable Range	Description
Advanced Settings	Gain	0 to 2000	The brightness of each color component red, green, and blue is called Gain. The chromaticity of "white" can be changed by adjusting the gain. Note <ul style="list-style-type: none"> Using this function may make some color gradations unavailable for display. The gain value changes according to the color temperature. When gain is changed, the color temperature is changed to "User".
	Black Level	0 to 1500	You can adjust the brightness and chromaticity for black by adjusting the levels of red, green, and blue, or by adjusting all of the black levels. Display the black test pattern or the background and adjust the black level.
	6 Colors	-100 to 100	The hue, saturation and lightness (brightness) can each be adjusted for the colors Magenta, Red, Yellow, Green, Cyan, and Blue.
Reset		-	Resets any color adjustment values for the currently selected color mode back to the default settings.

When the color mode is Calibration Mode (CAL mode: CAL1 / CAL2 / CAL3)

You can switch the Color Mode.

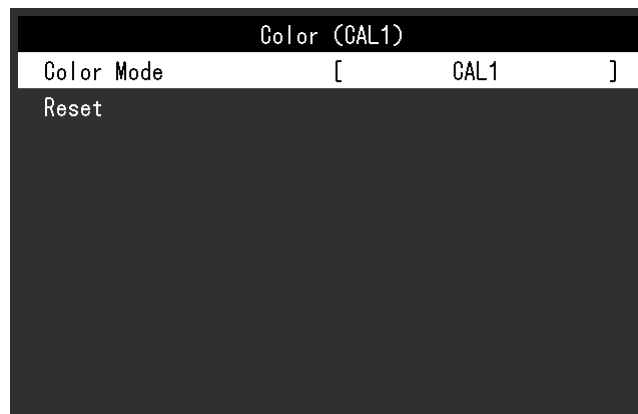



Function	Adjustable Range	Description
Color Mode	BT.2020 BT.709 DCI PQ_BT.2100 PQ_BT.709 PQ_DCI HLG_BT.2100 CAL1 CAL2 CAL3	Switch to the desired mode according to the monitor application. Note <ul style="list-style-type: none"> For more information on how to switch modes, see "2-3. Switching the Display Mode (color mode)" (page 11). Regarding "BT.2020 / BT.709 / DCI / PQ_BT.2100 / PQ_BT.709 / PQ_DCI / HLG_BT.2100", see page 16.
Reset	-	Resets any calibration targets for the currently selected color mode back to the default settings.

● Screen

The signal settings are used to configure advanced settings for input signals, such as the screen display size and color format.

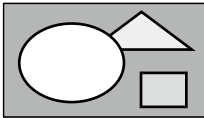
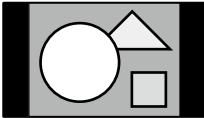

Function	Adjustable Range	Description
Picture Expansion	Auto Full Screen Aspect Ratio Dot by Dot	<p>The screen size of the monitor display can be changed.</p> <ul style="list-style-type: none"> "Auto" The monitor automatically changes the screen size according to the resolution information and aspect ratio information from the input signal. "Full Screen" Displays an image in full screen. Images are distorted in some cases because the vertical rate is not equal to the horizontal rate. "Aspect Ratio" Displays an image in full screen. However, since aspect ratios are maintained, part of an image may not be visible in horizontal or vertical direction. "Dot by Dot" Displays the image at the set resolution or at the size specified by the input signal. <p>Note</p> <ul style="list-style-type: none"> Example settings <ul style="list-style-type: none"> - Full Screen  - Aspect Ratio  - Dot by Dot (Input Signal) 

Function	Adjustable Range	Description
Zoom	Off Center Lower Left Upper Left Upper Right Lower Right	<p>When a 4K2K signal (a signal with a resolution of 4096 × 2160 or 3840 × 2160) is displayed on the monitor, the specified area can be doubled in size. This is convenient for checking details in an image.</p> <div data-bbox="742 398 1396 577" style="text-align: center;"> <p style="text-align: right;">Example: Enlarging "Upper Right"</p> </div> <p>Note</p> <ul style="list-style-type: none"> You cannot use this function if "Picture Setup" (page 34) in the "Administrator Settings" menu is set to "Dual". You cannot use this function with a 4K 60 Hz / 50 Hz HDMI signal.
BT.709 Gamut Warning	Off Clip On	<p>If a signal that complies with the ITU-R BT.2020 standard is input, you can set the display method for colors that exceed the color gamut for the BT.709 standard.</p> <ul style="list-style-type: none"> "Off" Images are displayed according to the color gamut for BT.2020. (The actual color gamut that is displayed on the monitor will depend on the setting for "Gamut Clipping" (page 20).) <div data-bbox="778 1048 1356 1227" style="text-align: center;"> <p style="text-align: center;">Color gamut defined by the BT.2020 standard Color gamut defined by the BT.709 standard</p> </div> <ul style="list-style-type: none"> "Clip" Colors that are outside of the color gamut for BT.709 are expressed within the color gamut for BT.709 (clipping occurs). <div data-bbox="778 1370 1356 1550" style="text-align: center;"> <p style="text-align: center;">Color gamut defined by the BT.2020 standard Color gamut defined by the BT.709 standard</p> </div> <ul style="list-style-type: none"> "On" Colors that are outside of the color gamut for BT.709 are displayed in gray. <div data-bbox="778 1693 1356 1872" style="text-align: center;"> <p style="text-align: center;">Color gamut defined by the BT.2020 standard Color gamut defined by the BT.709 standard</p> </div> <p>Note</p> <ul style="list-style-type: none"> This function can be set only when "Color Gamut" (page 18) is set to "BT.2020". This function and "Luminance Warning" cannot be enabled at the same time. If this function is set to "On" or "Clip", the "Luminance Warning" function is automatically set to "Off".





Function		Adjustable Range	Description
Luminance Warning		Off On (Yellow) On (Magenta)	<p>You can check areas with a brightness that is higher than the brightness that is set for the PQ Clipping function for the input signal (areas where clipping occurs).</p> <p style="text-align: right;">Example: Setting On (Magenta)</p> <div style="text-align: center;">  </div> <p>Note</p> <ul style="list-style-type: none"> • This function and "BT.709 Gamut Warning" cannot be enabled at the same time. If this function is set to "On", the "BT.709 Gamut Warning" function is automatically set to "Off".
Co-View		Off On	<p>If this function is set to "On", the monitor can be easily viewed at a wider angle, such as when multiple people are looking at the monitor at the same time.</p> <p>Note</p> <ul style="list-style-type: none"> • A halo effect might occur when this function is set to "On".
Marker	Safe Area Marker	Off On	<p>A safe area is an area that can be displayed on any type of device. If this function is set to "On", a frame is displayed around the safe area during video editing, etc. This allows you to visually confirm that subtitles and menus are arranged completely within the safe area.</p> <p>Note</p> <ul style="list-style-type: none"> • If "Picture Setup" (page 34) in the "Administrator Settings" menu is set to "Dual", a frame is displayed around the safe area only if the left and right screens have the same resolution. • If "Aspect Marker" is set to any setting other than "Off", the safe area setting is automatically set to "Off".
	Safe Area Size	80 % to 99 %	You can set the size of the safe area.

Function		Adjustable Range	Description
Marker	Aspect Marker	Off Marker 1 Marker 2	<p>A frame that supports the aspect ratios for video sizes that are regulated by digital cinema is displayed.</p> <ul style="list-style-type: none"> • "Off" No aspect marker is displayed. • "Marker 1" An outer frame is displayed. • "Marker 2" An outer frame and boundary lines that divide the image into three equal parts are displayed. This setting can be used to check the composition of an image. <p>Note</p> <ul style="list-style-type: none"> • This can be set when either of the following conditions is satisfied: <ul style="list-style-type: none"> - "Picture Setup" (page 34) in the "Administrator Settings" menu is set to "Single", and the display resolution is 2048 × 1080 or 4096 × 2160. - "Picture Setup" (page 34) in the "Administrator Settings" menu is set to "Dual", the left and right screens have the same resolution, and the combined resolution is DCI 2K / 4K. • The left and right outer frames are not displayed for a 4096 × 2160 signal. • If "Safe Area Marker" is set to "On", Aspect Marker is automatically set to "Off".
	Aspect Settings	1.85:1 2.35:1 2.39:1	You can set the aspect ratio for the displayed aspect marker.
	Border Color	White Red Green Blue Cyan Magenta Yellow Gray	<p>You can set the color of the frame.</p> <p>Note</p> <ul style="list-style-type: none"> • This setting applies to both "Safe Area Marker" and "Aspect Marker".

● Preferences

The monitor's settings can be configured to suit the usage environment or personal preference.

Preferences		
USB CHARGE Port	[Normal]
Power Save	[On]
Off Timer	[15h]
Indicator	[4]
Input Skip		
Mode Skip		
Custom Key		
Monitor Reset		

Function	Adjustable Range	Description
USB CHARGE Port	Normal Charging Only	<p>The USB downstream  port of the monitor supports USB 3.0 quick charging. By changing this setting to "Charging Only", devices connected to the  port can be charged more quickly than when using the "Normal" setting.</p> <p>Note</p> <ul style="list-style-type: none"> • Make sure to complete any communication between connected USB devices and the PC before switching this setting. When the setting is switched, all communication will be temporarily interrupted. • Devices that are connected to the  port must support quick charging. • When "Charging Only" is set, data communications between the PC and connected devices via the  port are not possible, and therefore, connected devices will not work. • When "Charging Only" is set, charging is possible even when the monitor and PC are not connected by USB cable.
Power Save	On Off	<p>This function allows you to set the monitor to the power saving mode, depending on the state of an external device connected to it.</p> <p>The monitor changes to power saving mode about 15 seconds after signal input ceases to be detected. When the monitor has shifted to power saving mode, images are not displayed on the screen.</p> <ul style="list-style-type: none"> • Exiting power saving mode <ul style="list-style-type: none"> - If the monitor receives input, it automatically exits power saving mode and returns to the normal display mode. <p>Note</p> <ul style="list-style-type: none"> • At the time of shifting to power saving mode, a message that indicates the transition is displayed 5 seconds in advance. • When you are not using the monitor, turn off the main power switch to cut down on power consumption. • When the monitor is in power saving mode, devices connected to the USB downstream port will still work. Therefore, power consumption of the monitor varies depending on the connected devices, even in the power saving mode.

Function		Adjustable Range	Description
Off Timer		Off 6h 9h 12h 15h 18h	You can set the time for the monitor's power to automatically turn off. The monitor will automatically turn off when the time set here elapses after the monitor is turned on, or after the monitor wakes up from Power Save. Note <ul style="list-style-type: none"> • One minute before the Off Timer function is triggered, a message is displayed to notify you that the monitor's power will be turned off. • Only the power button can be operated while this message is displayed.
Indicator		Off 1 to 7	The brightness of the power button and the control buttons when the screen is displayed can be set. (Default setting: 4)
Input Skip		Skip -	This function allows skipping of input signals that will not be used when the input signals are switched. Note <ul style="list-style-type: none"> • Not all input signals can be set to "Skip".
Mode Skip		Skip -	This function allows skipping of modes that will not be used when selecting modes. Please use this function if display modes are limited, or if you want to prevent randomly changing the display status. Note <ul style="list-style-type: none"> • Not all modes can be set to "Skip".
Custom Key	[F1]	Off Input Range Zoom BT.709 Gamut Warning Luminance Warning Co-View Safe Area Marker Aspect Marker Prev. Color Mode Information	You can set the function that is assigned to the [F1] key. Note <ul style="list-style-type: none"> • By default, this key is set to the "Luminance Warning" function. • Regarding the custom keys, see "Chapter 4 Custom Key Settings" (page 29).
	[F2]	Off Input Range Zoom BT.709 Gamut Warning Luminance Warning Co-View Safe Area Marker Aspect Marker Prev. Color Mode Information	You can set the function that is assigned to the [F2] key. Note <ul style="list-style-type: none"> • By default, this key is set to the "Information" function. • Regarding the custom keys, see "Chapter 4 Custom Key Settings" (page 29).
Monitor Reset		-	Restores all settings to their default values, except for the settings in the "Administrator Settings" menu.

● Languages

The display language for menus and messages can be selected.

Adjustable Range

English, Deutsch, Français, Español, Italiano, Svenska, Japanese, Simplified Chinese, Traditional Chinese



● Information

You can check the monitor information (model name, serial number, firmware version, usage time) and the input signal information.

Example:

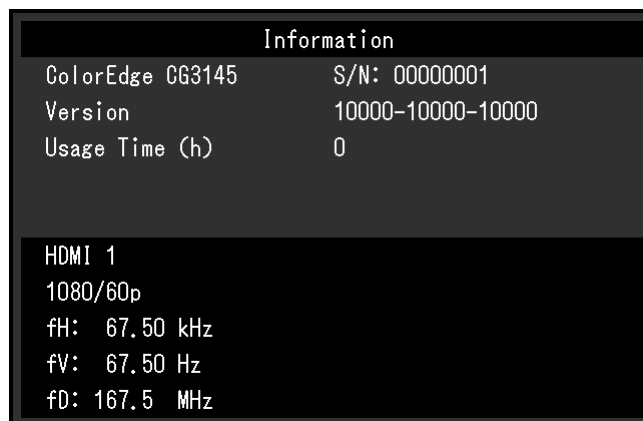

Chapter 4 Custom Key Settings

You can assign functions to the custom keys to easily start specified functions.

You can assign functions of your choice to the custom keys.

This chapter describes how to operate the custom keys and how to assign functions to the custom keys.

4-1. Basic Operation of the Custom Keys

1. Displaying the operation guide



1. Press any of the buttons (except ).

The operation guide appears.



2. Execute

1. Select  or .

The function assigned to  or  is executed.

Note

- If you press a custom key to which no function has been assigned, the menu for assigning a function to that custom key appears.

4-2. Assigning a Function to a Custom Key

1. Displaying the operation guide

1. Press any of the buttons (except ).

The operation guide appears.

2. Setting

1. Select .

The Setting menu appears.



- Use **^** **v** to select "Preferences", and then select **✓**.

The Preferences menu appears.

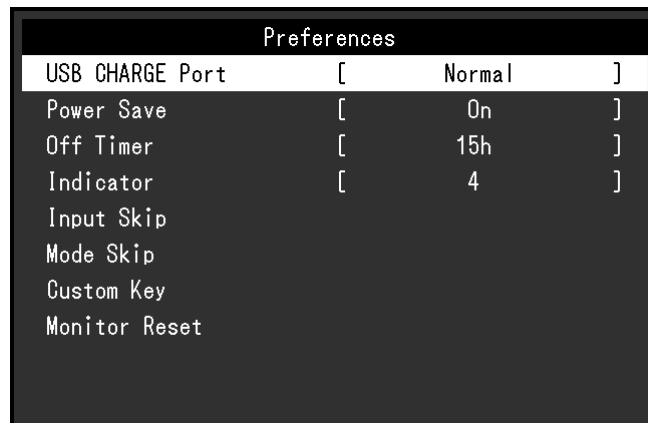

- Use **^** **v** to select "Custom Key", and then select **✓**.

The Custom Key menu appears.



- Use **^** **v** to select the custom key to which you want to assign a function, and then select **✓**.

The menu for assigning a function appears.

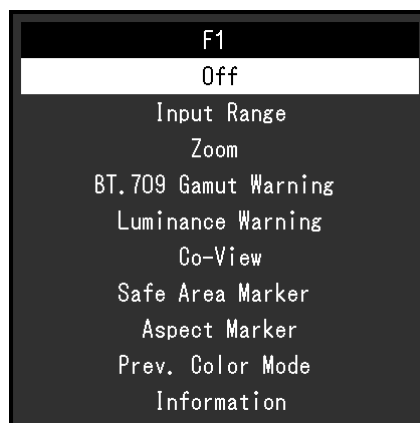

- Use **^** **v** to select the function that you want to assign, and then select **✓**.

That function is assigned to the custom key.

3. Exiting

- Press **x** several times.

The Setting menu exits.

● Functions that can be Assigned to Custom Keys

Function	Description
Off	Disables the specified custom key.
Input Range	Sets the Input Range function. For more information, see page 15 .
Zoom	Sets the Zoom function. For more information, see page 23 .
BT.709 Gamut Warning	Sets the BT.709 Gamut Warning function. For more information, see page 23 .
Luminance Warning	Sets the Luminance Warning function. For more information, see page 24 .
Co-View	Sets the Co-View function. For more information, see page 24 .
Safe Area Marker	Sets the Safe Area Marker function. For more information, see page 24 .
Aspect Marker	Sets the Aspect Marker function. For more information, see page 25 .
Prev. Color Mode	You can return to the previous color mode. This is convenient for checking the differences between two color modes.
Information	<p>You can view the input signal information and color information.</p> <p>Example:</p> <div style="display: flex; justify-content: space-around;"> <div style="background-color: #333; color: #eee; padding: 5px; border: 1px solid #555;"> <p style="text-align: center; margin: 0;">Information (1/2)</p> <p>Signal</p> <p>Input Color Format Auto (YUV 4:2:2)</p> <p>Input Range Auto (Limited)</p> <p>Signal Information</p> <p>HDMI 1</p> <p>4096 X 2160 60.00 Hz</p> <p>Limited Range</p> <p>YCbCr4:2:2</p> <p>BT.709</p> <p>Hybrid Log Gamma</p> </div> <div style="background-color: #333; color: #eee; padding: 5px; border: 1px solid #555;"> <p style="text-align: center; margin: 0;">Information (2/2)</p> <p>Color</p> <p>Color Mode BT.2020</p> <p>Brightness 100cd/m2</p> <p>Temperature 6500K</p> <p>Gamma (EOTF) 2.2</p> <p>PQ Clipping -</p> <p>HLG System Gamma -</p> <p>Color Gamut BT.2020</p> </div> </div> <p>Note</p> <ul style="list-style-type: none"> You can check the monitor information under "Information" (page 28) on the Setting menu.

Chapter 5 Administrator Settings

This chapter describes how to configure monitor operation using the "Administrator Settings" menu. This menu is for administrators. Configuration on this menu is not required for normal monitor use.

5-1. Basic Operation of the "Administrator Settings" Menu

1. Menu display

1. Press \odot to turn off the monitor.
2. While pressing the leftmost button, press \odot for more than 2 seconds to turn on the monitor.

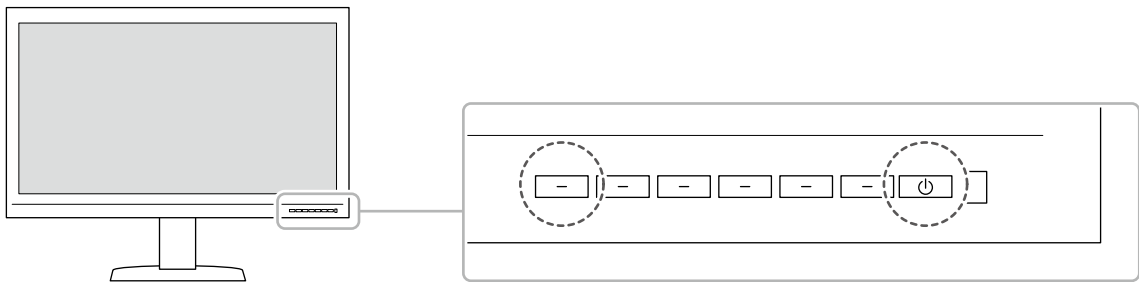

The "Administrator Settings" menu appears.

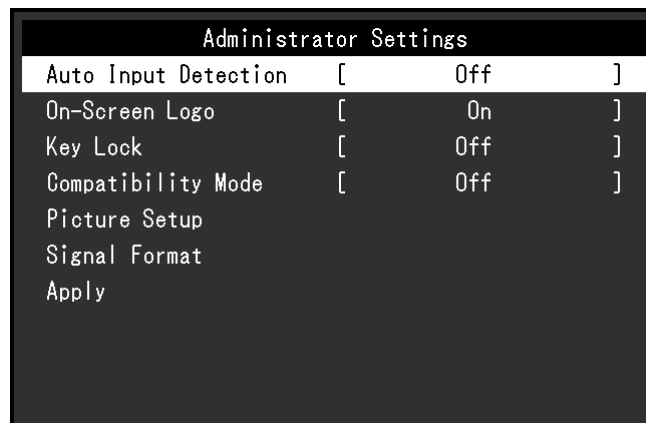

2. Setting

1. Choose an item to set with \wedge \vee , and then select \checkmark .
The Adjustment/Setting menu appears.

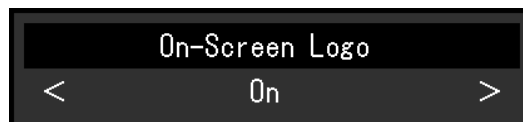



2. Set the item with \leftarrow \rightarrow , and then select \checkmark .
The "Administrator Settings" menu appears.

3. Applying and exiting

1. Select "Apply", and then select \checkmark .
The settings are confirmed and the "Administrator Settings" menu quits.

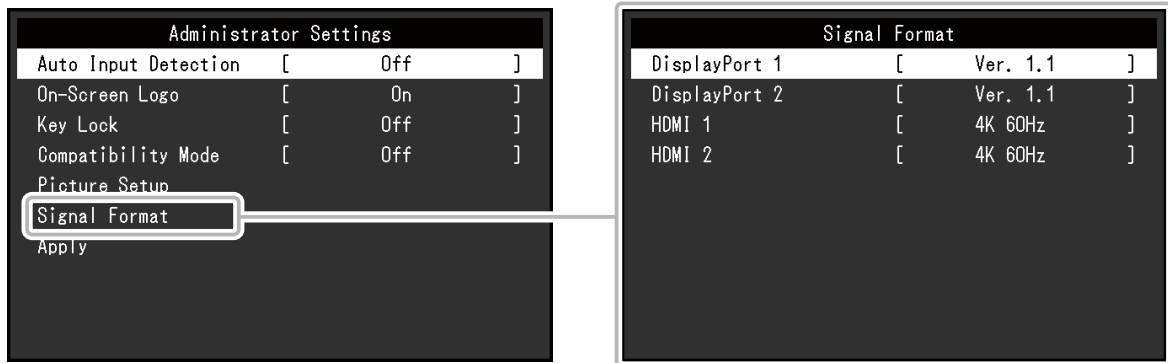
5-2. "Administrator Settings" Menu Functions

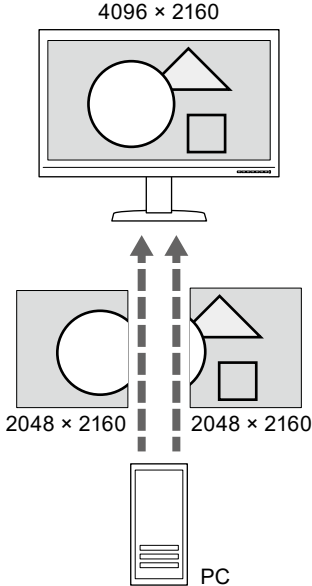
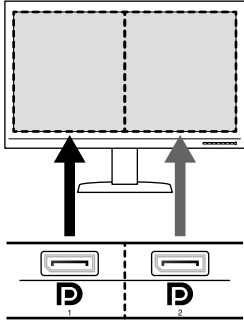

Function	Adjustable Range	Description
Auto Input Detection	Off On	<p>When this function is set to "On", the monitor automatically recognizes the connector through which signals are input, so that the screen can be displayed. If the input signal for the selected connector is lost, the monitor automatically switches to a different signal.</p> <p>When set to "Off", the monitor displays the signal from the selected connector regardless of whether a signal is input or not. In this case, select the input signal to display using the control button () on the front of the monitor.</p>
On-Screen Logo	Off On	When this function is set to "Off", the EIZO logo that is displayed when the monitor is turned on does not appear.
Key Lock	Off Menu All	<p>In order to prevent changes to settings, the control buttons on the front of the monitor can be locked.</p> <ul style="list-style-type: none"> • "Off" (Default setting) All buttons are enabled. • "Menu" The  button is locked. • "All" All buttons except the power button are locked.
Compatibility Mode	Off On	<p>To avoid the following effects, set this function to "On".</p> <ul style="list-style-type: none"> • When you switch the monitor's power back on or return from power saving mode, windows or icons may have shifted position. • The PC's power save function does not operate correctly.

Function		Adjustable Range	Description
Picture Setup	DisplayPort	Single Dual	<p>To input two separate signals from a single PC into the monitor, and view the side-by-side on the left and right sides of the screen, change this setting to "Dual".</p> <p>For example, if your graphics board does not support a 4K2K (4096 × 2160) signal output, you can use this setting to display two 2048 × 2160 side-by-side on a 4K2K screen.</p>  <p style="text-align: center;">4096 × 2160</p> <p style="text-align: center;">2048 × 2160 2048 × 2160</p> <p style="text-align: center;">PC</p> <p>Note</p> <ul style="list-style-type: none"> For a "Dual" display, the signal that is input to DisplayPort 1 is displayed on the left side of the screen, and the signal that is input to DisplayPort 2 is displayed on the right side.  <ul style="list-style-type: none"> The resolutions that are supported for the "Dual" setting are shown below. 640×480 / 720×400 / 800×600 / 1024×768 / 1280×960 / 1280×1024 / 1600×1200 / 1920×1080 / 1920×1200 / 1920×2160 / 2048×2160 When using "Dual" display, the connector settings of the screen on the left, such as the Color setting, will be applied.
Signal Format	DisplayPort 1 DisplayPort 2 HDMI 1 HDMI 2	Ver. 1.1 Ver. 1.2 Extra 4K 30Hz 4K 60Hz 4K 60Hz Extra	<p>You can switch the signal type that the monitor can display. Try changing this setting if the input signal is not displayed, or if the displayed image does not appear correctly.</p> <p>Note</p> <ul style="list-style-type: none"> The default setting for 4K 30Hz and 4K 60Hz Extra is 1920 × 1080.

Chapter 6 SDR/HDR Settings

This chapter describes how to configure the monitor settings to use this monitor for image creation.

“6-1. About Each Color Mode” (page 35) describes applications and configurations of each color mode.

“6-2. Setting Procedure” (page 43) describes the procedure to configure each color mode settings suitable for the display of each application.

“6-3. Settings with ColorNavigator 7” (page 47) describes the overview of procedure to configure settings using software.

Attention

- See “Information” (page 28) to check the firmware version of your monitor before configuring the settings. Refer to our web site (www.eizoglobal.com/support/db/products/manual/CG3145#tab02) for drivers, and download the program and update the firmware if its version is different from the latest version.

Note

- It takes about 30 minutes (under our measurement conditions) for the monitor display to stabilize. Please wait 30 minutes or more after the monitor power has been turned on, and then adjust the monitor.
- If you switch SDR color modes (BT.2020, BT.709, and DCI) and HDR color modes (PQ_BT.2100, PQ_BT.709, PQ_DCI, and HLG_BT.2100), wait 30 minutes or more after switching the color modes, and then adjust the monitor.

6-1. About Each Color Mode

● Types and Applications of Color Modes for Image Creation

Color Mode	Application
BT.2020	(SDR) This color mode is suitable for reproducing ITU-R BT.2020 standard-compliant color gamut and gamma.
BT.709	(SDR) This color mode is suitable for reproducing ITU-R BT.709 standard-compliant color gamut and gamma.
DCI	(SDR) This color mode is suitable for reproducing DCI standard-compliant color gamut and gamma.
PQ_BT.2100	(HDR) This color mode is suitable for reproducing ITU-R BT.2100 standard-compliant color gamut in PQ format gamma (EOTF).
PQ_BT.709	(HDR) This color mode is suitable for reproducing ITU-R BT.709 standard-compliant color gamut in PQ format gamma (EOTF).
PQ_DCI	(HDR) This color mode is suitable for reproducing DCI standard-compliant color gamut in PQ format gamma (EOTF).
HLG_BT.2100	(HDR) This color mode is suitable for reproducing ITU-R BT.2100 standard-compliant color gamut in HLG format gamma (EOTF).

The relation between input signal (10 bits: 0 - 1023) and the brightness displayed on the monitor when each color mode is configured properly is described below. For more information about how to configure the settings, see “6-2. Setting Procedure” (page 43).

● BT.2020

The relation between input signal (0 - 1023) and the brightness displayed on the monitor is described below.

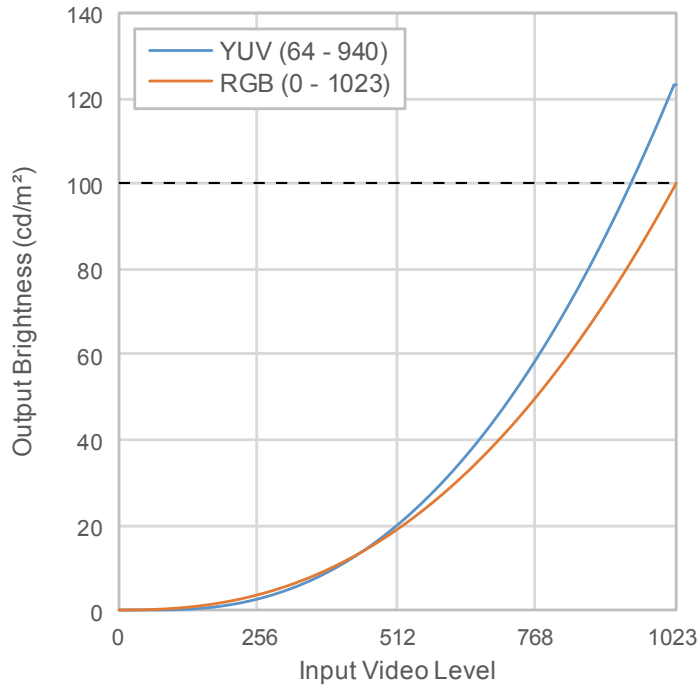

Main Setting Items of Setting Menu

For more information about procedure to configure the settings, see “6-2. Setting Procedure” (page 43).

Item		Input Color Format*1	
		RGB	YUV
Signal	YUV Color Matrix	Auto	BT.2020*2
	Input Range	Full	Limited (109 % white)
Color	Brightness (cd/m ²)	100	123
	Temperature	D65	D65
	Gamma (EOTF)	2.4	2.4
	Color Gamut	BT.2020	BT.2020

*1 If the image is properly displayed, the color format information (shown in blue rectangle in the figure on the right) can be viewed in “Signal” - “Signal Information” in the Setting menu. If the text including “YCbCr” is displayed in blue rectangle in the figure on the right, the input signal is YUV. If the text including “RGB” is displayed, the input signal is RGB.

*2 A conversion constant other than BT.2020 may be applied due to restrictions or settings of your equipment and tools.

```
Signal Information
HDMI 1
4096 X 2160 60.00 Hz
Limited Range
YCbCr4:2:2 10bit
BT.2020YCbCr
SMPTE ST 2084
```

● BT.709

The relation between input signal (0 - 1023) and the brightness displayed on the monitor is described below.

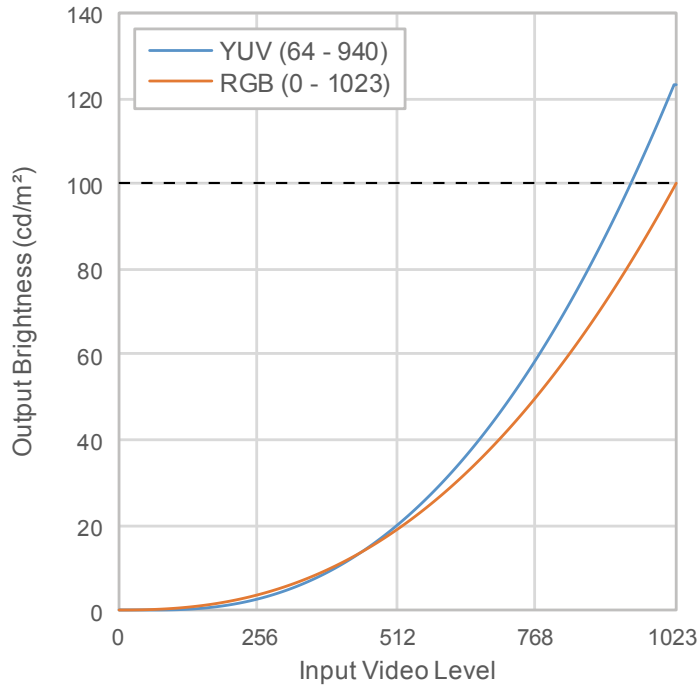

Main Setting Items of Setting Menu

For more information about procedure to configure the settings, see “6-2. Setting Procedure” (page 43).

Item		Input Color Format*1	
		RGB	YUV
Signal	YUV Color Matrix	Auto	BT.709
	Input Range	Full	Limited (109 % white)
Color	Brightness (cd/m ²)	100	123
	Temperature	D65	D65
	Gamma (EOTF)	2.4	2.4
	Color Gamut	BT.709	BT.709

*1 If the image is properly displayed, the color format information (shown in blue rectangle in the figure on the right) can be viewed in “Signal” - “Signal Information” in the Setting menu. If the text including “YCbCr” is displayed in blue rectangle in the figure on the right, the input signal is YUV. If the text including “RGB” is displayed, the input signal is RGB.

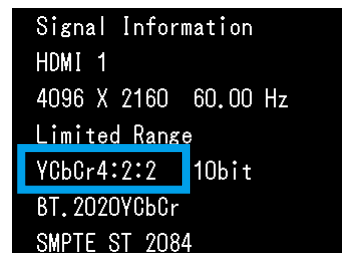

● DCI

The relation between input signal (0 - 1023) and the brightness displayed on the monitor is described below.

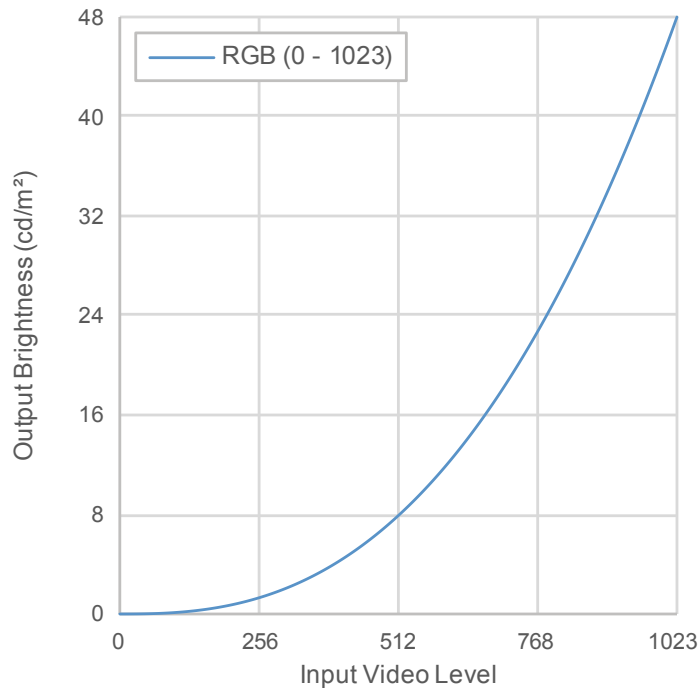

Main Setting Items of Setting Menu

For more information about procedure to configure the settings, see [“6-2. Setting Procedure”](#) (page 43).

Item		Input Color Format
		RGB
Signal	YUV Color Matrix	Auto
	Input Range	Full
Color	Brightness (cd/m ²)	48
	Temperature	D65
	Gamma (EOTF)	2.6
	Color Gamut	DCI

● PQ_BT.2100

The relation between input signal (0 - 1023) and the brightness displayed on the monitor is described below.

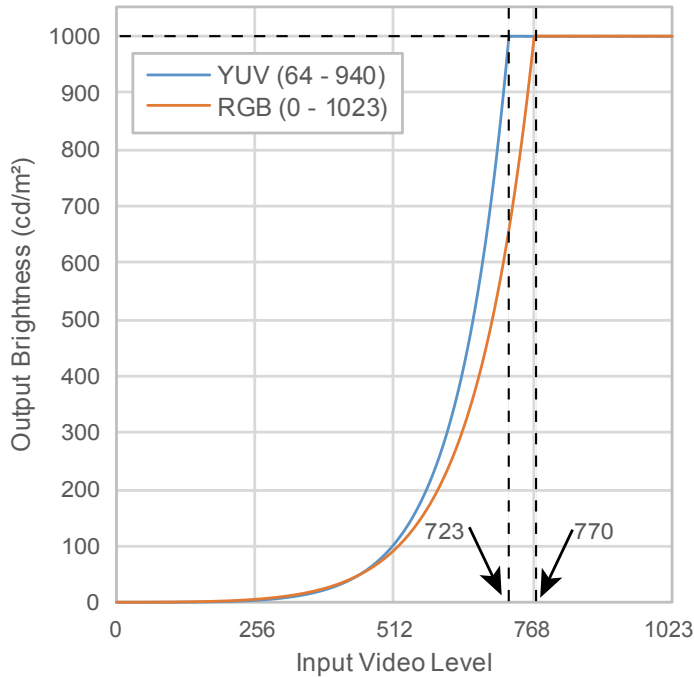

Main Setting Items of Setting Menu

For more information about procedure to configure the settings, see “6-2. Setting Procedure” (page 43).

Item		Input Color Format*1	
		RGB	YUV
Signal	YUV Color Matrix	Auto	BT.2020*2
	Input Range	Full	Limited
Color	Brightness (cd/m ²)	1000	1000
	Temperature	D65	D65
	Gamma (EOTF)	PQ	PQ
	PQ Clipping (cd/m ²)*3	1000	1000
	Color Gamut	BT.2020	BT.2020

*1 If the image is properly displayed, the color format information (shown in blue rectangle in the figure on the right) can be viewed in “Signal” - “Signal Information” in the Setting menu. If the text including “YCbCr” is displayed in blue rectangle in the figure on the right, the input signal is YUV. If the text including “RGB” is displayed, the input signal is RGB.

*2 A conversion constant other than BT.2020 may be applied due to restrictions or settings of your equipment and tools.

*3 For more information, see “PQ Clipping” (page 17) and “Setting and Display of PQ Clipping” (page 19).

```
Signal Information
HDMI 1
4096 X 2160 60.00 Hz
Limited Range
YCbCr4:2:2 10bit
BT.2020YCbCr
SMPTE ST 2084
```

● PQ_BT.709

The relation between input signal (0 - 1023) and the brightness displayed on the monitor is described below.

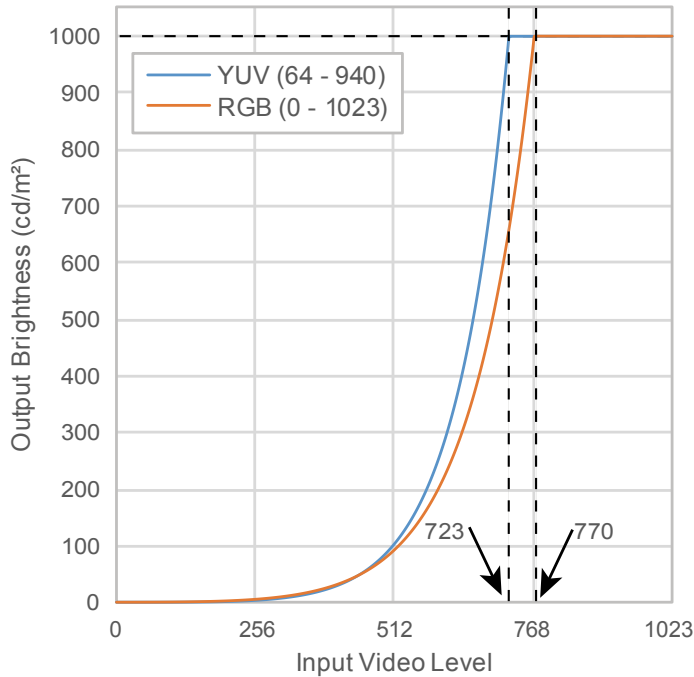

Main Setting Items of Setting Menu

For more information about procedure to configure the settings, see “6-2. Setting Procedure” (page 43).

Item		Input Color Format*1	
		RGB	YUV
Signal	YUV Color Matrix	Auto	BT.709
	Input Range	Full	Limited
Color	Brightness (cd/m ²)	1000	1000
	Temperature	D65	D65
	Gamma (EOTF)	PQ	PQ
	PQ Clipping (cd/m ²) ²	1000	1000
	Color Gamut	BT.2020	BT.2020

*1 If the image is properly displayed, the color format information (shown in blue rectangle in the figure on the right) can be viewed in “Signal” - “Signal Information” in the Setting menu. If the text including “YCbCr” is displayed in blue rectangle in the figure on the right, the input signal is YUV. If the text including “RGB” is displayed, the input signal is RGB.

*2 For more information, see “PQ Clipping” (page 17) and “Setting and Display of PQ Clipping” (page 19).

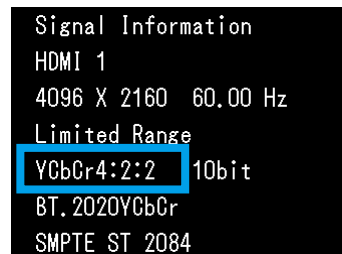

● PQ_DCI

The relation between input signal (0 - 1023) and the brightness displayed on the monitor is described below.

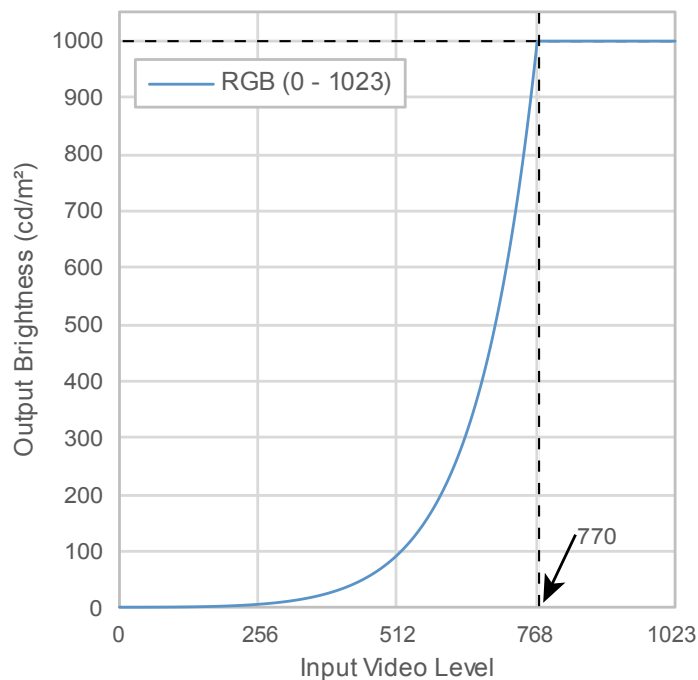

Main Setting Items of Setting Menu

For more information about procedure to configure the settings, see [“6-2. Setting Procedure” \(page 43\)](#).

Item		Input Color format
		RGB
Signal	YUV Color Matrix	Auto
	Input Range	Full
Color	Brightness (cd/m ²)	1000
	Temperature	D65
	Gamma (EOTF)	PQ
	PQ Clipping (cd/m ²) ^{*1}	1000
	Color Gamut	DCI

*1 For more information, see [“PQ Clipping” \(page 17\)](#) and [“Setting and Display of PQ Clipping” \(page 19\)](#).

● HLG_BT.2100

The relation between input signal (0 - 1023) and the brightness displayed on the monitor is described below.

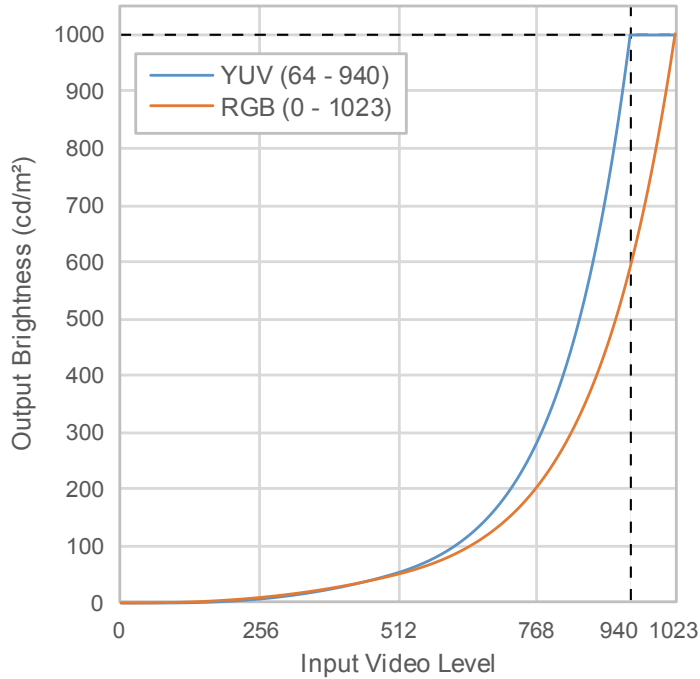

Main Setting Items of Setting Menu

For more information about procedure to configure the settings, see “6-2. Setting Procedure” (page 43).

Item		Input Color Format*1	
		RGB	YUV
Signal	YUV Color Matrix	Auto	BT.2020*2
	Input Range	Full	Limited
Color	Brightness (cd/m ²)	1000	1000
	Temperature	D65	D65
	Gamma (EOTF)	HLG	HLG
	HLG System Gamma	1.2	1.2
	Color Gamut	BT.2020	BT.2020

*1 If the image is properly displayed, the color format information (shown in blue rectangle in the figure on the right) can be viewed in “Signal” - “Signal Information” in the Setting menu. If the text including “YCbCr” is displayed in blue rectangle in the figure on the right, the input signal is YUV. If the text including “RGB” is displayed, the input signal is RGB.

*2 A conversion constant other than BT.2020 may be applied due to restrictions or settings of your equipment and tools.

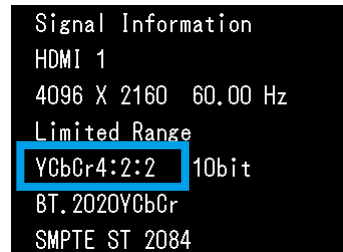

6-2. Setting Procedure

This section describes the procedure to use the monitor with the settings suitable for displaying SDR or HDR image.

Note

- For more information about SDR/HDR setting procedure with ColorNavigator 7, see “6-3. Settings with ColorNavigator 7” (page 47).

1. Select a color mode.

Select a color mode suitable for the application.

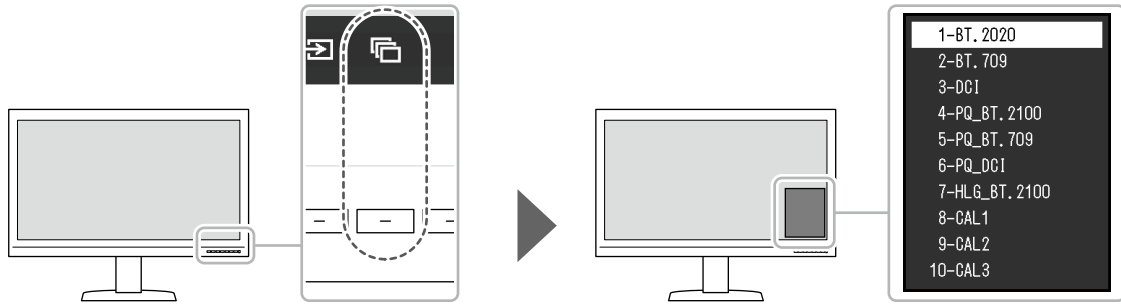

Color Mode	Application	
BT.2020	(SDR)	This color mode is suitable for reproducing ITU-R BT.2020 standard-compliant color gamut and gamma.
BT.709	(SDR)	This color mode is suitable for reproducing ITU-R BT.709 standard-compliant color gamut and gamma.
DCI	(SDR)	This color mode is suitable for reproducing DCI standard-compliant color gamut and gamma.
PQ_BT.2100	(HDR)	This color mode is suitable for reproducing ITU-R BT.2100 standard-compliant color gamut in PQ format gamma (EOTF).
PQ_BT.709	(HDR)	This color mode is suitable for reproducing ITU-R BT.709 standard-compliant color gamut in PQ format gamma (EOTF).
PQ_DCI	(HDR)	This color mode is suitable for reproducing DCI standard-compliant color gamut in PQ format gamma (EOTF).
HLG_BT.2100	(HDR)	This color mode is suitable for reproducing ITU-R BT.2100 standard-compliant color gamut in HLG format gamma (EOTF).

2. Display “Signal” in the Setting menu, and configure the settings required.

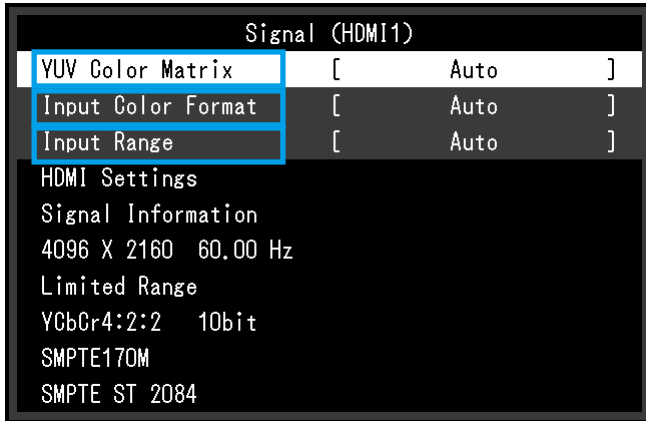

Note

- For more information about basic operation of the Setting menu, see [“3-1. Basic Operation of the Setting Menu” \(page 13\)](#).

1. If the image is not properly displayed, set “Input Color Format” in the “Signal” menu.
If the text including “YCbCr” is displayed in “Signal Information” in the “Signal” menu, the input signal is YUV.
If the text including “RGB” is displayed, the input signal is RGB.
2. If the YUV signal is displayed, “YUV Color Matrix” is set.

Settings for each color mode selected are shown below.

Color Mode	YUV Color Matrix
BT.2020	BT.2020
BT.709	BT.709
PQ_BT.2100	BT.2020
PQ_BT.709	BT.709
HLG_BT.2100	BT.2020

Note

- If the input signal is RGB, use the default setting.
- A conversion constant other than BT.2020 may be applied due to restrictions or settings of your equipment and tools. If it is the case, configure the settings properly for your equipment and tools.

3. Set “Input Range”.

Settings for each color mode and color format selected are shown below.

Color Mode	Input Color Format	Input Range
BT.2020	RGB	Full
	YUV	Limited (109 % white)
BT.709	RGB	Full
	YUV	Limited (109 % white)
DCI	RGB	Full
	YUV	Limited
PQ_BT.2100	RGB	Full
	YUV	Limited
PQ_BT.709	RGB	Full
	YUV	Limited
PQ_DCI	RGB	Full
HLG_BT.2100	RGB	Full
	YUV	Limited

3. Display “Color” in the Setting menu, and configure the settings required.

Color (PQ_BT.2100)		
Color Mode	[PQ_BT.2100]
Brightness	[1000cd/m2]
Temperature	[065]
Gamma (EOTF)	[PQ]
PQ Clipping	[1000cd/m2]
HLG System Gamma	[-]
Color Gamut	[BT.2020]
Advanced Settings		
Reset		

Note

- It is recommended to perform “Reset” in “Color” before configuring the settings. If you perform “Reset”, no additional configuration is required except for the SDR image with YUV signal.

Settings for each color mode and color format selected are shown below.

Color Mode	Input Color Format	Brightness (cd/m ²)	Gamma (EOTF)
BT.2020	RGB	100	2.4
	YUV	123 ^{*1}	2.4
BT.709	RGB	100	2.4
	YUV	123 ^{*1}	2.4
DCI	RGB	48	2.6
PQ_BT.2100	RGB	1000	PQ
	YUV	1000	PQ
PQ_BT.709	RGB	1000	PQ
	YUV	1000	PQ
PQ_DCI	RGB	1000	PQ
HLG_BT.2100	RGB	1000	HLG
	YUV	1000	HLG

Settings for Advanced Settings are left default. For more information, see [“Color Mode Setting Values” \(page 12\)](#).

4. Close the Setting menu to complete settings.

Select **X** to exit “Color” and display the Setting menu. Select **X** again to exit the Setting menu.

● List of Setting Items

Signal

Color Mode	Input Color Format	YUV Color Matrix	Input Range ^{*1}
BT.2020	RGB	Auto	Full
	YUV	BT.2020 ^{*1}	Limited (109 % white)
BT.709	RGB	Auto	Full
	YUV	BT.709 ^{*1}	Limited (109 % white)
DCI	RGB	Auto	Full
PQ_BT.2100	RGB	Auto	Full
	YUV	BT.2020 ^{*1}	Limited
PQ_BT.709	RGB	Auto	Full
	YUV	BT.709 ^{*1}	Limited
PQ_DCI	RGB	Auto	Full
HLG_BT.2100	RGB	Auto	Full
	YUV	BT.2020 ^{*1}	Limited

*1 This item is changed from the default setting.

Color

-: Cannot be changed

Color Mode	Color Format	Brightness (cd/m ²)	Temperature	Gamma (EOTF)	PQ Clipping (cd/m ²)	HLG System Gamma	Color Gamut
BT.2020	RGB	100	D65	2.4	-	-	BT.2020
	YUV	123 ^{*1}					
BT.709	RGB	100	D65	2.4	-	-	BT.709
	YUV	123 ^{*1}					
DCI	RGB	48	D65	2.6	-	-	DCI
PQ_BT.2100	RGB	1000	D65	PQ	1000	-	BT.2020
	YUV						
PQ_BT.709	RGB	1000	D65	PQ	1000	-	BT.709
	YUV						
PQ_DCI	RGB	1000	D65	PQ	1000	-	DCI
HLG_BT.2100	RGB	1000	D65	HLG	-	1.2	BT.2020
	YUV						

*1 This item is changed from the default setting.

6-3. Settings with ColorNavigator 7

You can use ColorNavigator 7 to configure monitor settings suitable for SDR or HDR display. It is recommended to use ColorNavigator 7 to calibrate the monitor for the following cases.

- To perform regular calibration
ColorNavigator 7 has a function to notify when to perform calibration.
- To verify whether the monitor is properly calibrated
ColorNavigator 7 has a function to verify calibration status.

Note

- For more information about how to perform adjustment by operating only the Setting menu of the monitor, see “6-2. Setting Procedure” (page 43).
 - For more information about ColorNavigator 7, refer to our web site.
(www.eizoglobal.com/products/coloredge/cn7)
-

● Setting Procedure

1. Select a color mode in the Setting menu in the monitor

See step 1 in “6-2. Setting Procedure” (page 43) to configure the setting.

2. Display “Signal” in the Setting menu of the monitor, and configure the settings required

See step 2 in “6-2. Setting Procedure” (page 43) to configure the setting.

Note

- See “List of Setting Items” (page 46) for the list of setting items.
-

3. Start ColorNavigator 7

4. Point the color mode selected in the color mode list, right-click, and select “Edit target”

5. Set the color mode type to “Advanced”

6. Set the adjustment target according to the application

For more information, see “Target Settings of ColorNavigator 7” (page 48).

● Target Settings of ColorNavigator 7

Color Mode Type, Brightness, Black Level, Temperature

Color Mode	Color Format	Color Mode Type	Brightness (cd/m ²)	Black Level	Temperature
BT.2020	RGB	Advanced*1	100	Minimum Value	D65
	YUV		123*1		
BT.709	RGB	Advanced*1	100	Minimum Value	D65
	YUV		123*1		
DCI	RGB	Advanced*1	48	Minimum Value	D65
PQ_BT.2100	RGB	Advanced*1	1000	Minimum Value	D65
	YUV				
PQ_BT.709	RGB	Advanced*1	1000	Minimum Value	D65
	YUV				
PQ_DCI	RGB	Advanced*1	1000	Minimum Value	D65
HLG_BT.2100	RGB	Advanced*1	1000	Minimum Value	D65
	YUV				

*1 This item is changed from the default setting.

Gamma (EOTF), PQ Clipping, HLG System Gamma, Adjustment Method

-: Cannot be changed

Color Mode	Color Format	Gamma (EOTF)	PQ Clipping (cd/m ²)	HLG System Gamma	Adjustment Method
BT.2020	RGB	2.4	-	-	Standard
	YUV				
BT.709	RGB	2.4	-	-	Standard
	YUV				
DCI	RGB	2.6	-	-	Standard
PQ_BT.2100	RGB	PQ	1000	-	Standard
	YUV				
PQ_BT.709	RGB	PQ	1000	-	Standard
	YUV				
PQ_DCI	RGB	PQ	1000	-	Standard
HLG_BT.2100	RGB	HLG	-	1.2	Standard
	YUV				

Color Gamut, Gamut Clipping

Color Mode	Color Format	Color Gamut (Standard Value)	Gamut Clipping
BT.2020	RGB	BT.2020	On
	YUV		
BT.709	RGB	BT.709	On
	YUV		
DCI	RGB	DCI	On
PQ_ BT.2100	RGB	BT.2020	On
	YUV		
PQ_BT.709	RGB	BT.709	On
	YUV		
PQ_DCI	RGB	DCI	On
HLG_ BT.2100	RGB	BT.2020	On
	YUV		

Chapter 7 Calibration

You can use ColorNavigator 7 and a measurement device (calibration sensor) to perform calibration and maintain the quality of the monitor.

You can download the ColorNavigator 7 from our web site.

www.eizoglobal.com/products/coloredge/cn7

Attention

- If you calibrate this monitor, install the measurement device on a tripod or a similar fixing base, and place it approximately 5 cm to 20 cm away from the panel surface. If the measurement device is in contact with the panel during measurement, heat will accumulate on the panel, which may impair the measuring accuracy.

Example: i1 Pro2

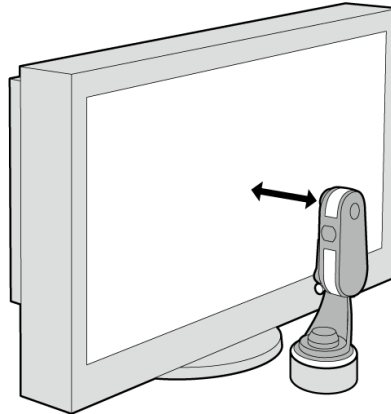



Note

- It takes about 30 minutes (under our measurement conditions) for the monitor display to stabilize. Please wait 30 minutes or more after the monitor power has been turned on, and then adjust the monitor.
 - If you switch SDR color modes (BT.2020, BT.709, and DCI) and HDR color modes (PQ_BT.2100, PQ_BT.709, PQ_DCI, and HLG_BT.2100), wait 30 minutes or more after switching the color modes, and then adjust the monitor.
 - When using this software, you will need to connect a PC to the monitor with the supplied USB cable.
 - For details on the USB cable connection, see “9-2. Making Use of the USB Hub Function” (page 55).
 - You can also use ColorNavigator NX. You can download the ColorNavigator NX from our web site.
www.eizoglobal.com/products/coloredge/cn_nx
 - While using ColorNavigator 7 or ColorNavigator NX, do not operate the power button or control buttons on the front side of the monitor.
-

Chapter 8 Troubleshooting

8-1. No Picture

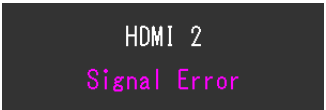
Problem	Possible cause and remedy
1. No picture <ul style="list-style-type: none"> Power indicator does not light up. 	<ul style="list-style-type: none"> Check whether the power cord is connected properly. Turn on the main power switch on the rear side of the monitor. Press . Turn off the main power switch on the rear side of the monitor, and then turn it on again a few minutes later.
<ul style="list-style-type: none"> Power indicator is lighting blue. 	<ul style="list-style-type: none"> Increase "Brightness" and/or "Gain" in the Setting menu (see "Color" (page 16)).
<ul style="list-style-type: none"> Power indicator is lighting orange. 	<ul style="list-style-type: none"> Switch the input signal. Move the mouse or press any key on the keyboard. Check whether the PC is turned on. Turn off the main power switch on the rear side of the monitor, and then turn it on again.
<ul style="list-style-type: none"> Power indicator is flashing orange and blue. 	<ul style="list-style-type: none"> This problem may occur when a PC is connected via the DisplayPort connector. Connect via the signal cable specified by EIZO, turn off the monitor, and then turn it on again.
2. The message below appears.	This message appears when the signal is not input correctly even though the monitor is functioning properly.
<ul style="list-style-type: none"> This message appears when no signal is input. <p>Example:</p> 	<ul style="list-style-type: none"> The message shown left may appear, because some PCs do not output the signal immediately after power-on. Check whether the PC is turned on. Check whether the signal cable is connected properly. Switch the input signal. Turn off the main power switch on the rear side of the monitor, and then turn it on again. For HDMI signal input, try changing "Signal Format" in the Setting menu (see "Signal Format" (page 34)).
<ul style="list-style-type: none"> The message shows that the input signal is out of the frequency specification range. <p>Example:</p> 	<ul style="list-style-type: none"> Check whether the PC is configured to meet the resolution and vertical scan frequency requirements of the monitor (see "Compatible Resolutions"). Reboot the PC. Change to the appropriate setting using the graphics board's utility. Refer to the User's Manual of the graphics board for details.

8-2. Imaging Problems

Problem	Possible cause and remedy
1. The screen is too bright or too dark.	<ul style="list-style-type: none"> Use "Brightness" in the Setting menu to adjust it (see "Color" (page 16)). The LCD monitor backlight has a limited life span. If the screen becomes dark or begins to flicker, contact your local EIZO representative.
2. Afterimages appear	<ul style="list-style-type: none"> Afterimages are particular to LCD monitors. Avoid displaying the same image for a long time. Use the screen saver or power saving function to avoid displaying the same image for extended periods of time.
3. Green/red/blue/white dots or defective dots remain on the screen.	<ul style="list-style-type: none"> This is due to LCD panel characteristics and not a malfunction.
4. Interference patterns or pressure marks remain on the screen.	<ul style="list-style-type: none"> Display a white or black image over the entire screen. The symptom may disappear.
5. Noise appears on the screen.	<ul style="list-style-type: none"> When inputting HDCP system signals, normal images may not be displayed immediately.
6. When you switch the power back on or return from power saving mode, windows or icons may have shifted position.	<ul style="list-style-type: none"> In the "Administrator Settings" menu, set "Compatibility Mode" to "On" (see "Compatibility Mode" (page 33)).
7. (DisplayPort or HDMI input) The screen colors look strange.	<ul style="list-style-type: none"> Try changing "Input Color Format" in the Setting menu (see "Input Color Format" (page 14)). For HDMI signal input, try changing "Signal Format" in the "Administrator Settings" menu (see "Signal Format" (page 34)).
8. The image does not display on the entire screen.	<ul style="list-style-type: none"> Try changing "Picture Expansion" in the Setting menu (see "Picture Expansion" (page 22)).

8-3. Other Problems

Problem	Possible cause and remedy
1. The Setting menu/Mode menu cannot be displayed	<ul style="list-style-type: none"> • Check whether the control button lock function works (see “Key Lock” (page 33)). • Control buttons are locked when the main window of ColorNavigator NX is displayed. Exit the software.
2. The monitor connected with the USB cable is not detected. / The peripheral USB device connected to the monitor does not work.	<ul style="list-style-type: none"> • Check whether the USB cable is connected correctly (see “9-2. Making Use of the USB Hub Function” (page 55)). • If a peripheral device is connected to the  port, try checking the "USB CHARGE Port" setting (see “USB CHARGE Port” (page 26)). If it is set to "Charging Only", the peripheral device will not work. • Try changing to a different USB port on the PC. • Try changing to a different USB port on the monitor. • Reboot the PC. • If the peripheral devices work correctly when the PC and peripheral devices are connected directly, contact your local EIZO representative. • Check whether the PC and OS are USB compliant. (For USB compliance of the respective devices, consult their manufacturers.) • Depending on the USB 3.0 host controller that you are using, connected USB devices may not be recognized correctly. Update to the latest USB 3.0 driver provided by each manufacturer, or connect the monitor to the USB 2.0 port. • Check the PC's BIOS setting for USB when using Windows. (Refer to the User's Manual of the PC for details.)
3. Audio is not output.	<ul style="list-style-type: none"> • This monitor does not support DisplayPort / HDMI audio signals.

Chapter 9 Reference

9-1. Connecting Multiple External Devices

The product allows you to connect multiple external devices and switch between them for display.

Connection examples

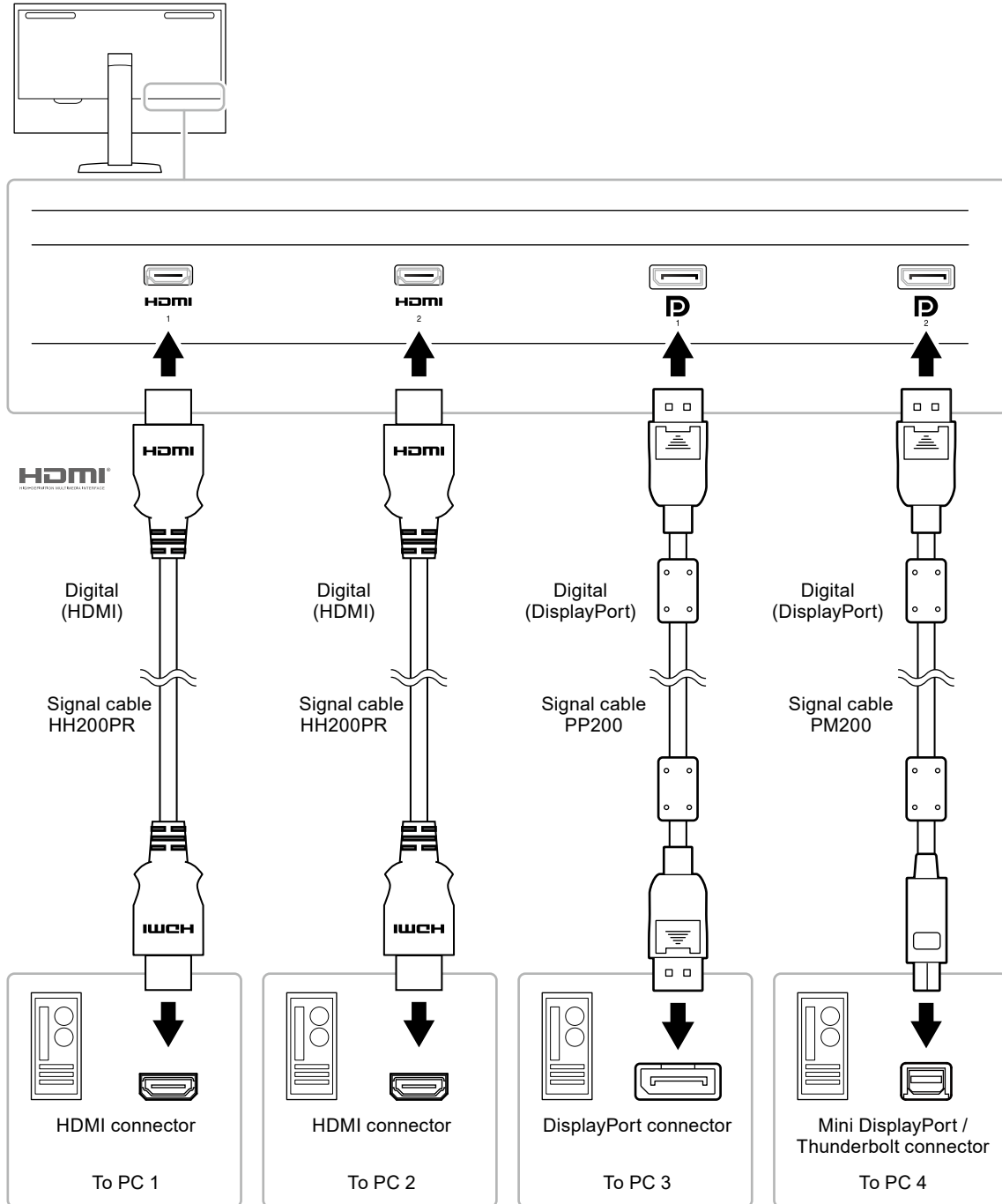

Note

- The input signal changes each time the control button () on the front of the monitor is pressed. For more information, see “2-2. Switching Input Signals” (page 11).
- The connector through which signals are input is recognized automatically, and images are displayed on the screen accordingly. For more information, see “Auto Input Detection” (page 33).

9-2. Making Use of the USB Hub Function

This monitor is equipped with a USB hub. It works as a USB hub when connected to a USB-compatible PC, allowing the connection of peripheral USB devices.

Note

- This product supports USB 3.0. When connecting peripheral devices that support USB 3.0, high-speed data communication is possible (however, only when the USB cable used to connect the PC and peripheral device is USB 3.0 compliant).
 - The ⚡ USB downstream port also supports quick charging. This allows you to recharge your smartphone or tablet in a short period of time. (See “USB CHARGE Port” (page 26))
-

● Required System Environment

- A PC equipped with a USB port
 - Windows 10 / Windows 8.1 / Windows 7, or Mac OS X 10.7.5 or later
 - USB cable (UU200SS (USB 3.0))
-

Attention

- This monitor may not work depending on the used PC, OS or peripheral devices. For USB compatibility of peripheral devices, contact their manufactures.
 - When the monitor is in power saving mode, devices connected to the USB downstream port will still work. Therefore, power consumption of the monitor varies depending on the connected devices, even in the power saving mode.
 - When the main power switch of the monitor is off, a device connected to the USB downstream port will not operate.
 - When the "USB CHARGE Port" setting in "Preferences" is set to "Charging Only", a peripheral device will not work if connected to the ⚡ USB downstream port.
 - Ensure that communication between all peripheral devices connected to the monitor and the PC is ended before switching the "USB CHARGE Port" setting. When the setting is switched, all communication will be temporarily interrupted.
-

● Connection Procedure (Setup of USB Function)



1. Connect the monitor to a PC using the signal cable, and start the PC.
2. Connect the USB cable between the USB downstream port of the PC and USB upstream port of the monitor.

The USB hub function is set up automatically upon connection of the USB cable.

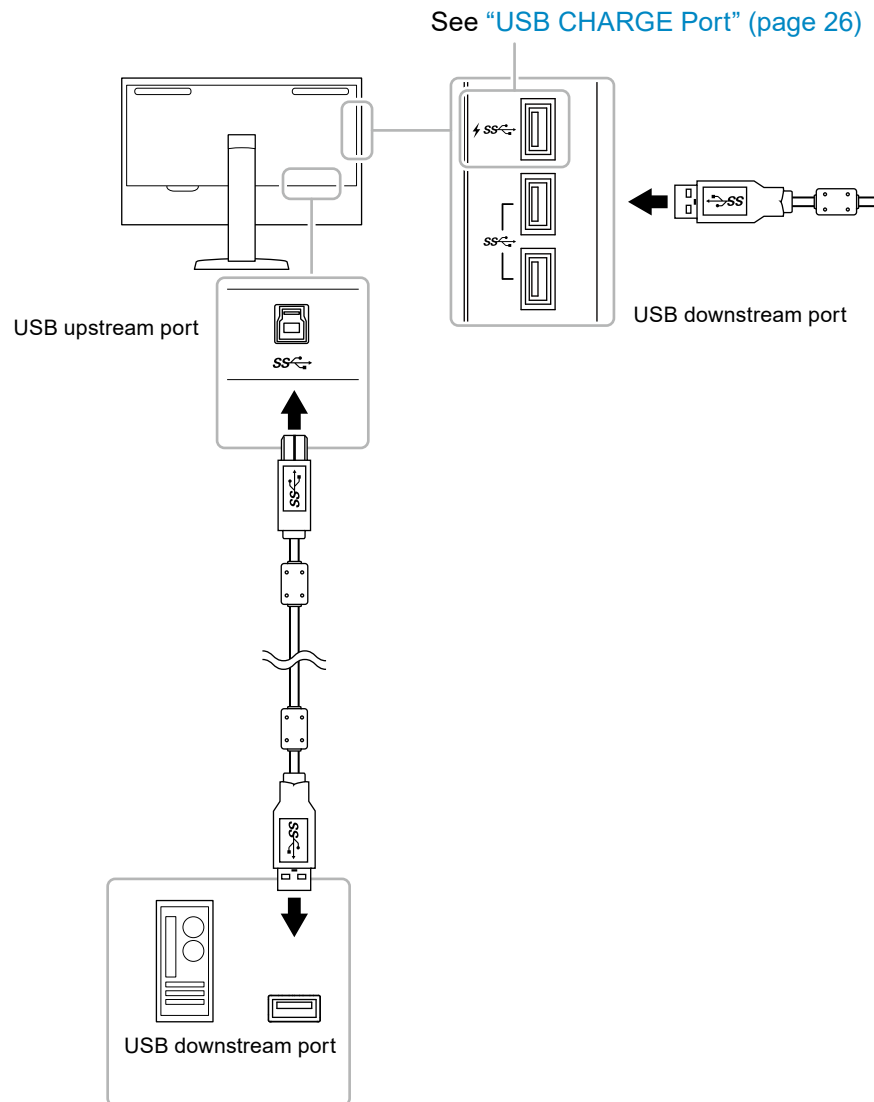
3. Connect the peripheral USB device to the USB downstream port of the monitor.



9-3. Specifications

LCD Panel	Type	IPS (Anti-Glare)
	Backlight	Wide color gamut LED
	Size	78.9 cm (31.1 inch)
	Resolution	4096 dots × 2160 lines
	Display Size (H × V)	698.0 mm × 368.1 mm
	Pixel Pitch	0.170 mm × 0.170 mm
	Display Colors	Approx. 1073.74 million colors: Supports 10-bit (24-bit LUT)
	Viewing Angle (H × V, typical)	178° / 178°
	Maximum Brightness (typical)	1000 cd/m ²
	Contrast Ratio (typical)	1,000,000:1
	Response Time (typical)	Black → White → Black: 20 ms Gray-to-gray: 10 ms
Color Gamut Display (typical)	DCI coverage: 99 %, NTSC ratio: 109 %	
Video Signals	Input Terminals	HDMI × 2: Supports 8-bit, 10-bit, and 12-bit displays* ¹ (HDCP-compatible) DisplayPort × 2: Supports 8-bit and 10-bit display (HDCP-compatible) *1 The maximum number of display bits is 10.
	Horizontal scan frequency	HDMI: 15 kHz to 136 kHz DisplayPort: 25 kHz to 137 kHz
	Vertical scan frequency	23 Hz to 61 Hz (For 720 x 400: 69 Hz to 71 Hz)
	Frame Synchronization mode	23.75 Hz to 30.25 Hz, 47.5 Hz to 60.5 Hz
	Dot clock (Max.)	HDMI: 600.0 MHz DisplayPort: 598.3 MHz
USB	Port	Upstream port × 1 Downstream port × 3 (The  port supports quick charging.)
	Standard	USB Specification Revision 3.1 Gen 1 USB Battery Charging Specification Rev.1.2
	Communication Speed	5 Gbps (super), 480 Mbps (high), 12 Mbps (full), 1.5 Mbps (low)
	Supply Current	Downstream: Max. 900 mA per 2 ports Downstream ( port): Normal: Max. 1.5 A per port, Charging Only: Max. 2.1 A per port
Power	Input	100–240 VAC ±10 %, 50/60 Hz 4.80 A–2.00 A
	Maximum Power Consumption	472 W or less
	Power Save Mode	1.2 W or less (When "Compatibility Mode" is set to "Off", "USB CHARGE Port" is set to "Normal", and no USB device is connected)
	Standby Mode	0.7 W or less (When "Compatibility Mode" is set to "Off", "USB CHARGE Port" is set to "Normal", and no USB device is connected)
Physical Specifications (Adjustable Stand)	Outside Dimensions (Without Monitor Hood)	Min. height: 757 mm × 487 mm × 323 mm (W × H × D) Max. height: 757 mm × 603 mm × 323 mm (W × H × D)
	Net Weight (Without Monitor Hood)	Approx. 29.2 kg
	Height adjustment	116 mm
	Swivel	344°

Physical Specifications (Base Stand)	Outside Dimensions (Without Monitor Hood)	757 mm × 488 mm × 236.5 mm (W × H × D)
	Net Weight (Without Monitor Hood)	Approx. 25.8 kg
Operating Environment Requirements	Temperature	0 °C to 30 °C
	Humidity	20 % to 80 % R.H. (no condensation)
	Air Pressure	540 hPa to 1060 hPa
Transportation/Storage Environment Requirements	Temperature	-20 °C to 60 °C
	Humidity	10 % to 90 % R.H. (no condensation)
	Air Pressure	200 hPa to 1060 hPa

● Accessories

Signal cable	PP200 (DisplayPort - DisplayPort) PM200 (Mini DisplayPort - DisplayPort) HH200PR (HDMI - HDMI)
--------------	--

For the latest information about the accessories, refer to our web site. www.eizoglobal.com

Appendix

Trademark

The terms HDMI and HDMI High-Definition Multimedia Interface, and the HDMI Logo are trademarks or registered trademarks of HDMI Licensing, LLC in the United States and other countries.

The DisplayPort Compliance Logo and VESA are registered trademarks of the Video Electronics Standards Association.

The SuperSpeed USB Trident Logo is a registered trademark of USB Implementers Forum, Inc.



The USB Power Delivery Trident Logos are trademarks of USB Implementers Forum, Inc.



DICOM is the registered trademark of the National Electrical Manufacturers Association for its standards publications relating to digital communications of medical information.

Kensington and Microsaver are registered trademarks of ACCO Brands Corporation.

Thunderbolt is a trademark of Intel Corporation in the United States and/or other countries.

Microsoft and Windows are registered trademarks of Microsoft Corporation in the United States and other countries.

Adobe is a registered trademark of Adobe Systems Incorporated in the United States and other countries.

Apple, macOS, Mac OS, OS X, Macintosh and ColorSync are registered trademarks of Apple Inc.

EIZO, the EIZO Logo, ColorEdge, CuratOR, DuraVision, FlexScan, FORIS, RadiCS, RadiForce, RadiNET, Raptor and ScreenManager are registered trademarks of EIZO Corporation in Japan and other countries.

ColorEdge Tablet Controller, ColorNavigator, EcoView NET, EIZO EasyPIX, EIZO Monitor Configurator, EIZO ScreenSlicer, G-Ignition, i•Sound, Quick Color Match, RadiLight, Re/Vue, SafeGuard, Screen Administrator, Screen InStyle, ScreenCleaner and UniColor Pro are trademarks of EIZO Corporation.

All other company and product names are trademarks or registered trademarks of their respective owners.

License

The bitmap font used for this product is designed by Ricoh Industrial Solutions Inc.

FCC Declaration of Conformity

For U.S.A., Canada Only

FCC Declaration of Conformity

We, the Responsible Party

EIZO Inc.

5710 Warland Drive, Cypress, CA 90630

Phone: (562) 431-5011

declare that the product

Trade name: EIZO

Model: ColorEdge PROMINENCE CG3145

is in conformity with Part 15 of the FCC Rules. Operation of this product is subject to the following two conditions: (1) this device may not cause harmful interference, and (2) this device must accept any interference received, including interference that may cause undesired operation.

This equipment has been tested and found to comply with the limits for a Class B digital device, pursuant to Part 15 of the FCC Rules. These limits are designed to provide reasonable protection against harmful interference in a residential installation. This equipment generates, uses, and can radiate radio frequency energy and, if not installed and used in accordance with the instructions, may cause harmful interference to radio communications. However, there is no guarantee that interference will not occur in a particular installation. If this equipment does cause harmful interference to radio or television reception, which can be determined by turning the equipment off and on, the user is encouraged to try to correct the interference by one or more of the following measures.

- * Reorient or relocate the receiving antenna.
- * Increase the separation between the equipment and receiver.
- * Connect the equipment into an outlet on a circuit different from that to which the receiver is connected.
- * Consult the dealer or an experienced radio/TV technician for help.

Changes or modifications not expressly approved by the party responsible for compliance could void the user's authority to operate the equipment.

Note

Use the attached specified cable below or EIZO signal cable with this monitor so as to keep interference within the limits of a Class B digital device.

- AC Cord
- Shielded Signal Cable (enclosed)

Canadian Notice

This Class B information technology equipment complies with Canadian ICES-003.
Cet équipement informatique de classe B est conforme à la norme NMB-003 du Canada.

