

Kurulum Kılavuzu

ColorEdge® CG2730

Renk Yönetimi LCD Monitörü

Önemli















Lütfen kendinizi güvenli ve etkin kullanıma alıştırmak için ÖNLEMLERİ, bu Kurma Kılavuzunu ve CD-ROM'da yüklü olan Kullanıcı Kılavuzunu dikkatle okuyun. Lütfen daha sonra bakmak için bu kılavuzu saklayın.

Kullanım Kılavuzunun da dahil olduğu en yeni ürün bilgileri için web sitemize bakın.

<http://www.eizoglobal.com>



1. Paketin İçindekiler

 <ul style="list-style-type: none">• Monitör	 <ul style="list-style-type: none">• Setup Guide (Kurulum Kılavuzu)	 <ul style="list-style-type: none">• PRECAUTIONS (ÖNLEMLER)
 <ul style="list-style-type: none">• Adjustment Certificate (Ayar Sertifikası)	 <ul style="list-style-type: none">• EIZO LCD Utility Disk	 <ul style="list-style-type: none">• ColorNavigator Quick Reference (ColorNavigator Hızlı Referans)
 <ul style="list-style-type: none">• DD200DL DVI Dual Link kablosu	 <ul style="list-style-type: none">• PM200 DisplayPort kablosu	
 <ul style="list-style-type: none">• UU200SS (USB 3.0) USB kablosu	 <ul style="list-style-type: none">• Güç kablosu	
 <ul style="list-style-type: none">• Montaj vidaları	 <ul style="list-style-type: none">• ScreenCleaner (Ekran Temizleyici)	
 <ul style="list-style-type: none">• Monitör Başlığı	 <ul style="list-style-type: none">• Monitör Başlığı Kullanıcı Kılavuzu	

2. Bağlantılar

1.

2.

3.

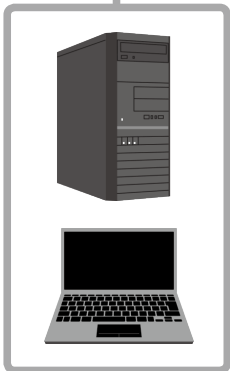
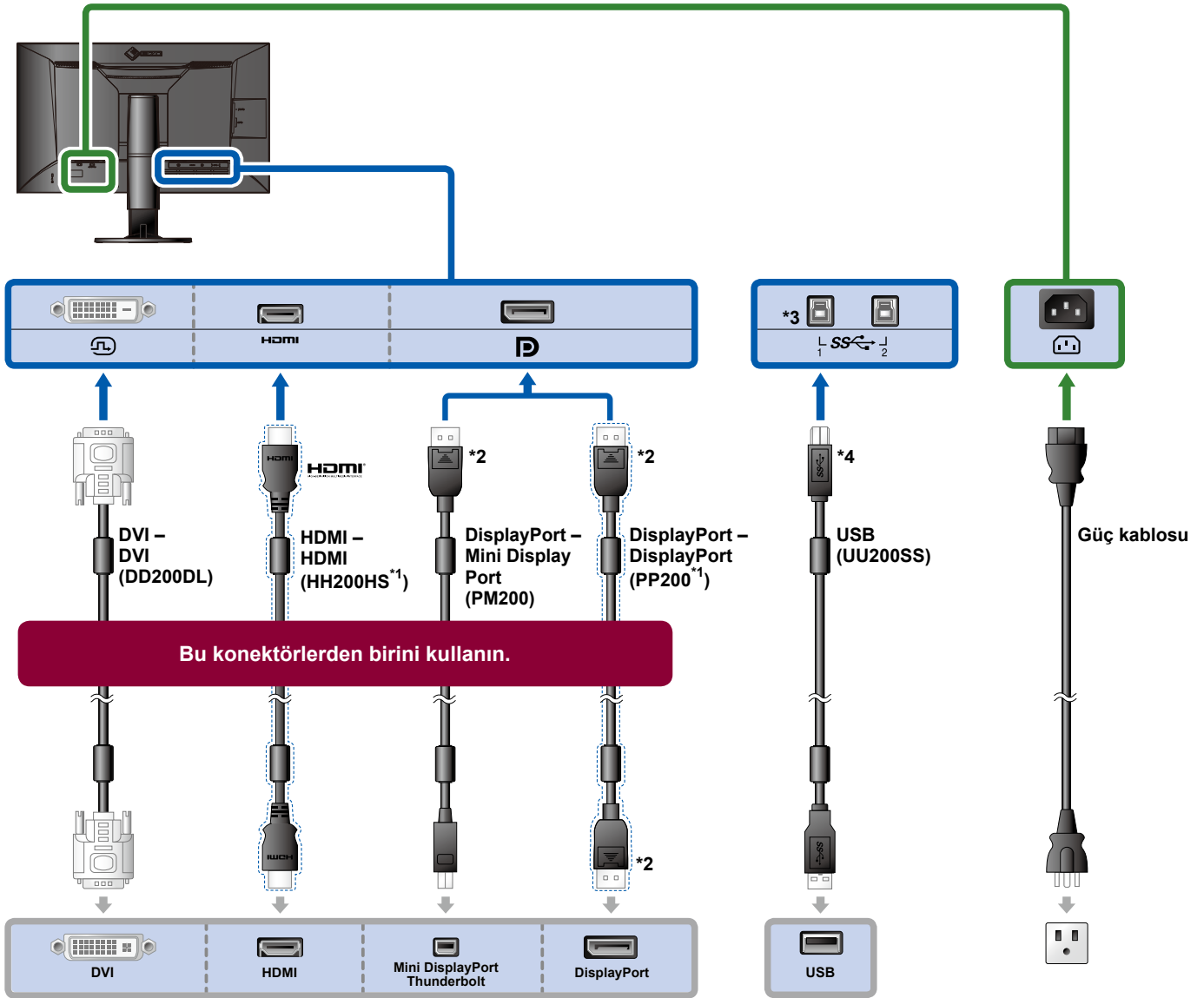

*1 seçenek

*2 Çıkarma yöntemi

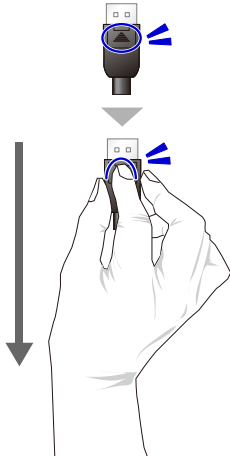

*3 1. portu kullanın. Varsayılan olarak, USB yukarı akış portu 2 devre dışıdır. Ayarları değiştirmek için, monitörün Kullanım Kılavuzuna bakın.

*4 ColorNavigator 6 kullanırken bu kablunun bağlı olduğundan daima emin olun.

4.

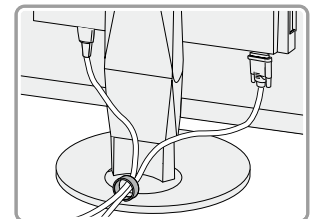
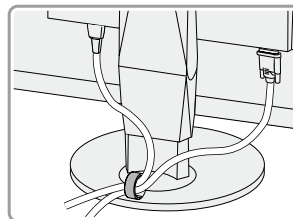

Standın arka kısmında kablo tutucunun kullanılması, kabloların düzgünce bir arada durmasını sağlar.

3. Açı ve Yükseklik Ayarı

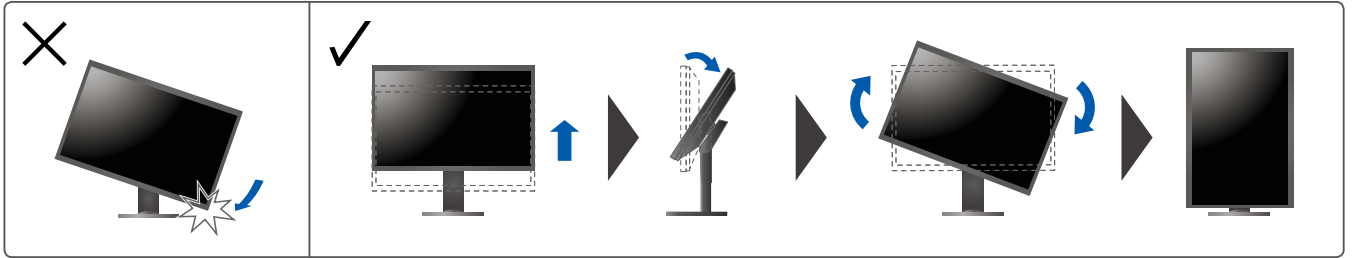
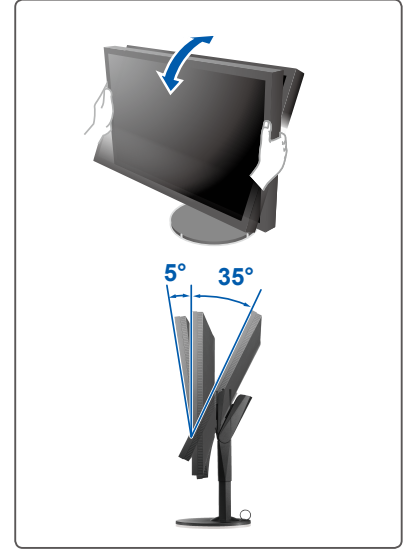
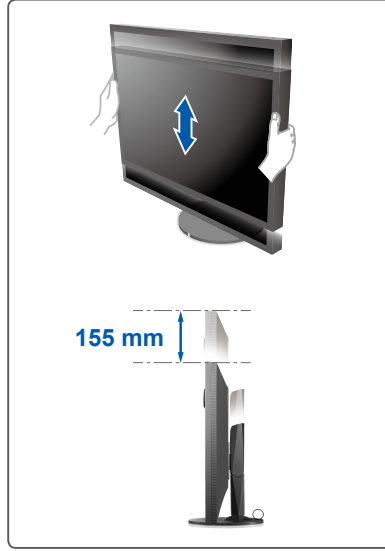
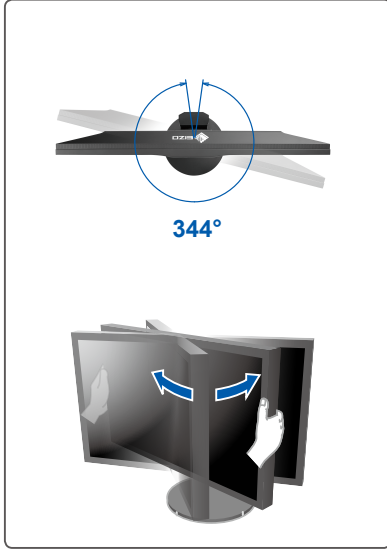

4. Ekran

1. Şebeke Güç Anahtarı

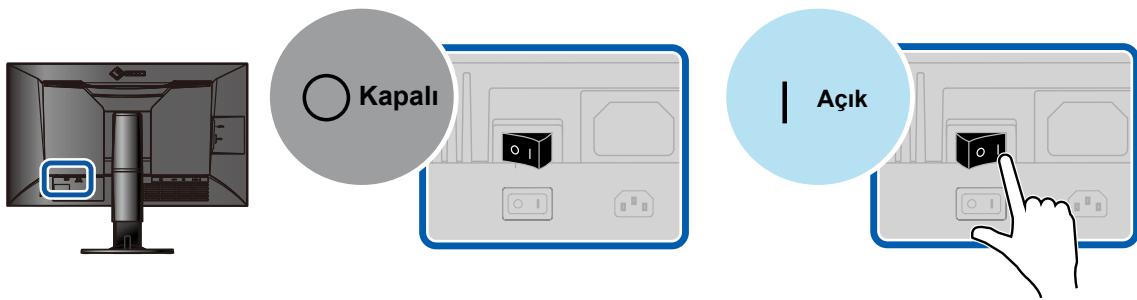

2. Güç Anahtarı

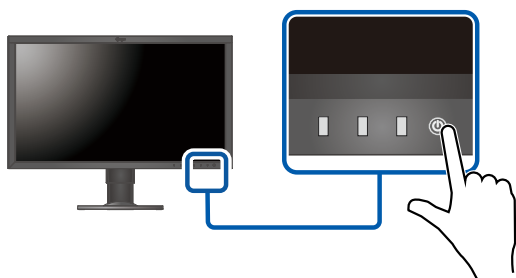

3. Önerilen Çözünürlük

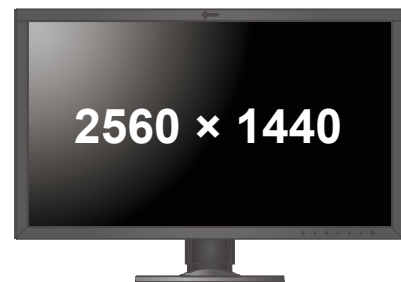

5. Dil

1.

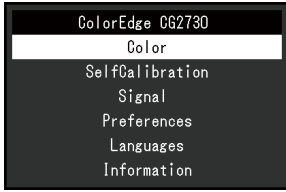
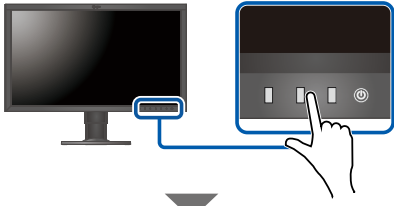

2.

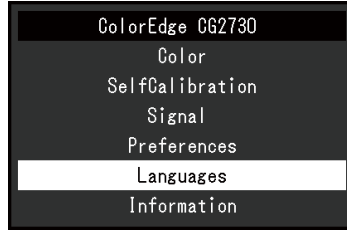
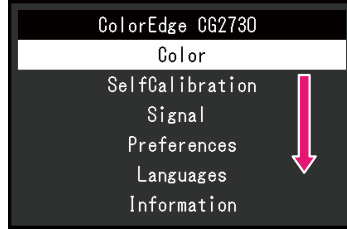
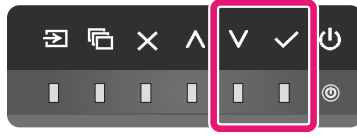

3.

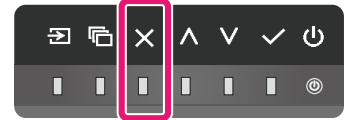
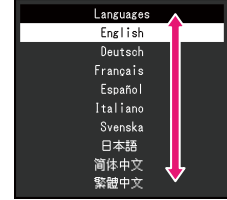
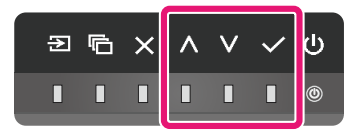

6. Başlık



- Kurulum hakkında ayrıntılar için Monitör Başlığı Kullanıcı Kılavuzuna bakın.

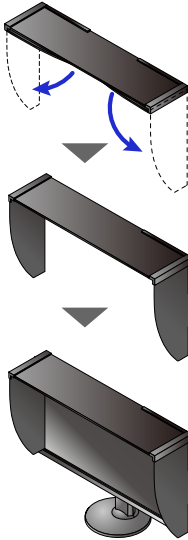

SelfCalibration

Periyodik olarak kalibrasyon yapmanıza olanak tanır.



Bu konumda sensörü durdurun.



- SelfCalibration hakkında ayrıntılar için CD-ROM'da bulunan Monitör Kullanıcı Kılavuzuna bakın.

ColorNavigator



- Kullanma talimatları için "Hızlı Referans"a ve ColorNavigator Kullanım Kılavuzuna (CD-ROM'da kayıtlıdır) bakın.

Görüntü Yok Sorunu

Gücü açmak için monitörde  düğmesine dokununuz.

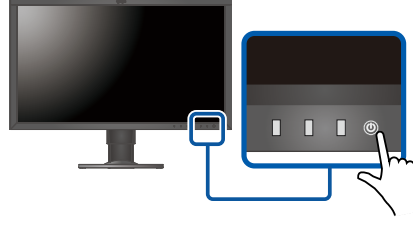

 düğmesinin ışığı beyaz yanıyor.

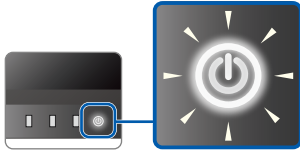

 düğmesinin ışığı yanmıyor.

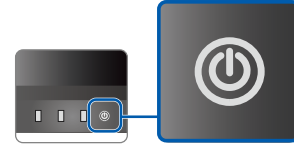

Monitörün gücünü açın.

- Monitörün arka kısmındaki şebeke güç anahtarını doğru şekilde açın.
- Güç kablosunun doğru takıldığını kontrol edin.

Ekranda bir mesaj görünüyor.



Bir sinyal girin.

- Sinyal kablosunun bağlandığı giriş terminaline geçiş yapmak için  düğmesine dokununuz.*1
- Sinyal kablosunun doğru bağlandığını kontrol edin.
- Bilgisayar uyku modunda olabilir. Fareyi veya klavyeyi çalıştırın.
- Bilgisayarın açık olduğunu kontrol edin.

Yukarıda belirtilen adımlar sorunu çözmezse, bilgisayarı yeniden başlatmayı deneyin.

- Monitörün arka kısmındaki şebeke güç anahtarını doğru şekilde açın.
- Bilgisayarı yeniden başlatın.

Ekranda bir mesaj görünüyor.



Bilgisayardan doğru sinyal verilmiyor.

- Bilgisayarı yeniden başlatın.
- Bilgisayardaki grafik sürücüsü düzgün çalışmıyor olabilir. Daha fazla ayrıntı için bilgisayar bayisi veya üreticisiyle iletişim kurun.

Ekranda mesaj görünmüyor.

- "Brightness" (Parlaklık) düzeyini artırın.*2
- Bilgisayarı yeniden başlatın.

*2

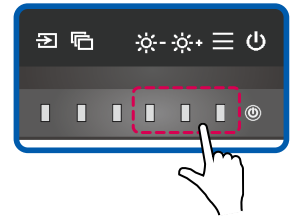

*1

