

Installatiegids

ColorEdge® CG2730

Color Management LCD-monitor

Belangrijk















Lees de PRECAUTIONS (VOORZORGSMATREGELEN), deze installatiegids en de gebruikershandleiding op de cd-rom aandachtig door, zodat u dit product veilig en effectief leert te gebruiken. Bewaar deze gids voor toekomstig gebruik.

Raadpleeg onze website voor de meest recente productinformatie inclusief de gebruikershandleiding.

<http://www.eizoglobal.com>



1. Inhoud van de doos

 <ul style="list-style-type: none">• Monitor	 <ul style="list-style-type: none">• Setup Guide (Installatiegids)	 <ul style="list-style-type: none">• PRECAUTIONS (VOORZORGSMATREGELEN)
 <ul style="list-style-type: none">• Adjustment Certificate (IJKcertificaat)	 <ul style="list-style-type: none">• EIZO LCD Utility Disk	 <ul style="list-style-type: none">• ColorNavigator Quick Reference (ColorNavigator Snelgids)
 <ul style="list-style-type: none">• DD200DL DVI Dual Link-kabel	 <ul style="list-style-type: none">• PM200 DisplayPort-kabel	
 <ul style="list-style-type: none">• UU200SS (USB 3.0) USB-kabel	 <ul style="list-style-type: none">• Netsnoer	
 <ul style="list-style-type: none">• Montageschroeven	 <ul style="list-style-type: none">• ScreenCleaner (SchermReiniger)	
 <ul style="list-style-type: none">• Monitorkap	 <ul style="list-style-type: none">• Gebruikershandleiding monitorkap	

2. Aansluitingen

1.

2.

3.

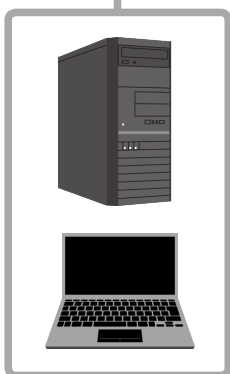
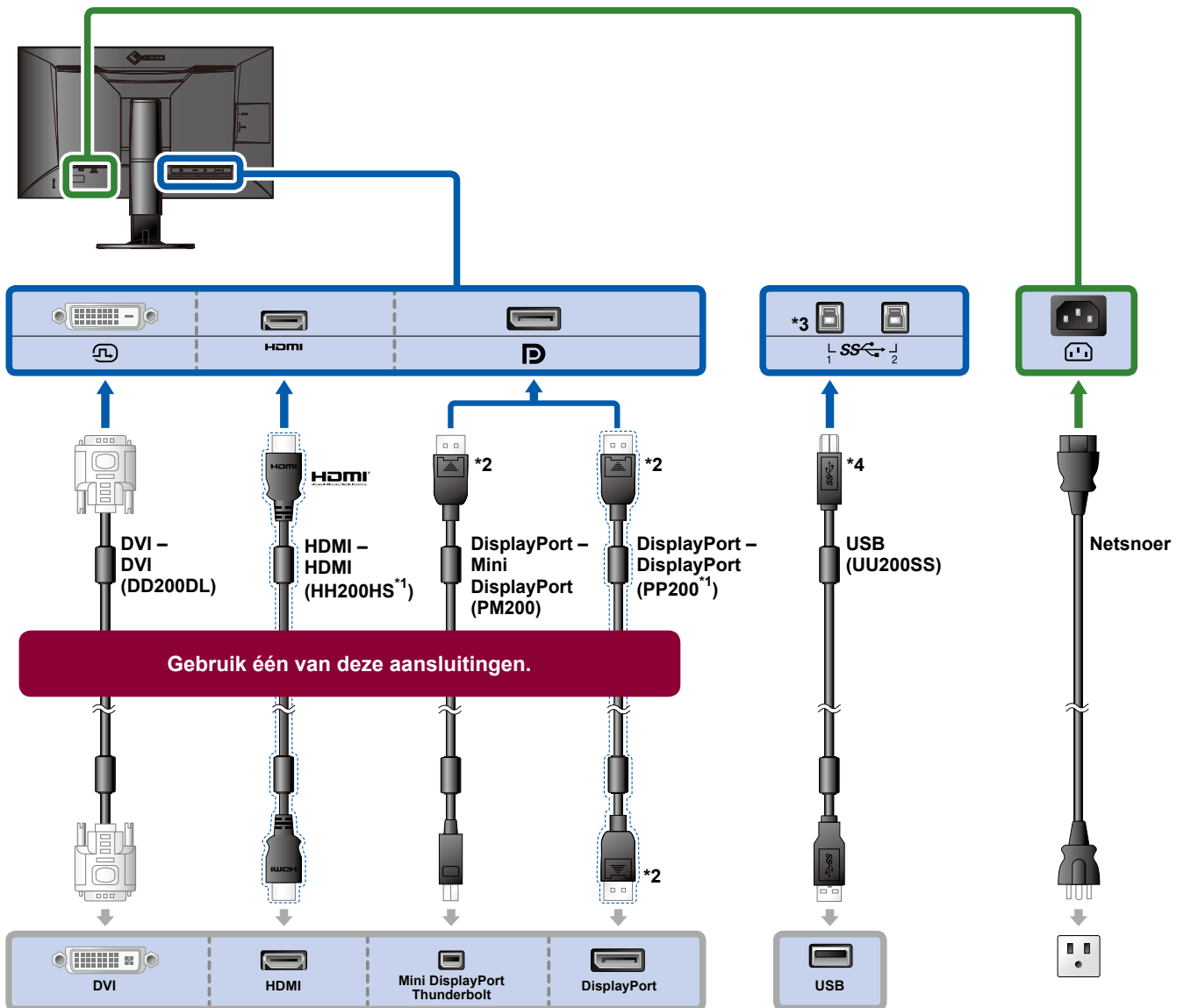

*1 optie

*2 Zo loskoppelen

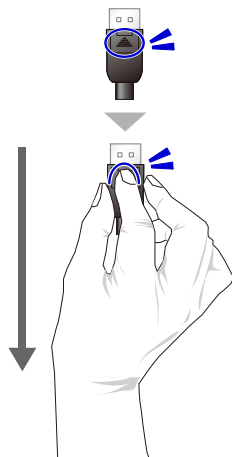

*3 Gebruik poort 1. USB-upstream-poort 2 is standaard uitgeschakeld. Raadpleeg de gebruikershandleiding van de monitor voor het wijzigen van de instellingen.

*4 Zorg er altijd voor dat deze kabel is aangesloten wanneer ColorNavigator 6 wordt gebruikt.

4.

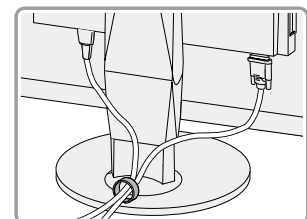
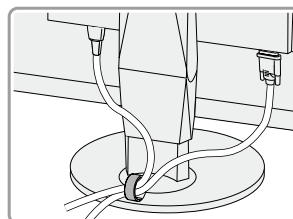

Met de kabelhouder aan de achterkant van de standaard worden de kabels netjes samengehouden.

3. Hoek- en hoogteverstelling

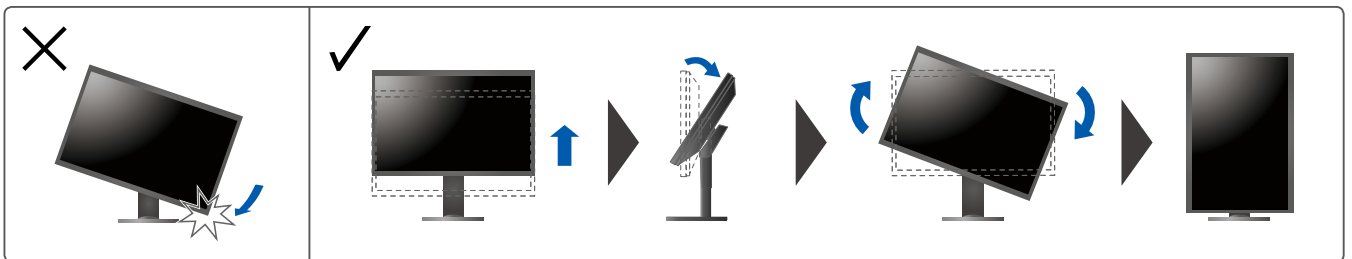
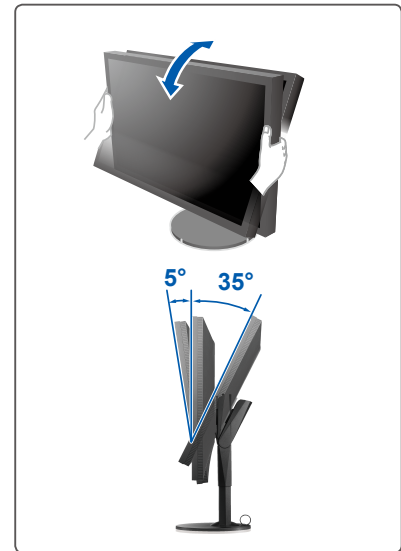
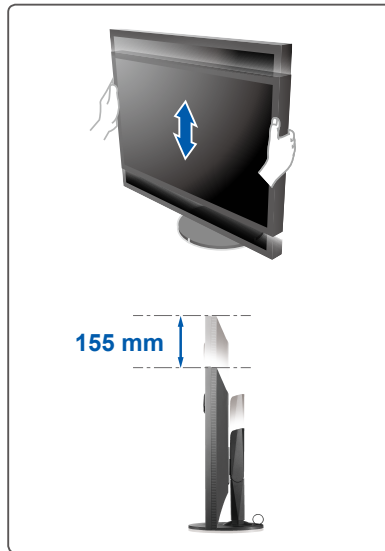
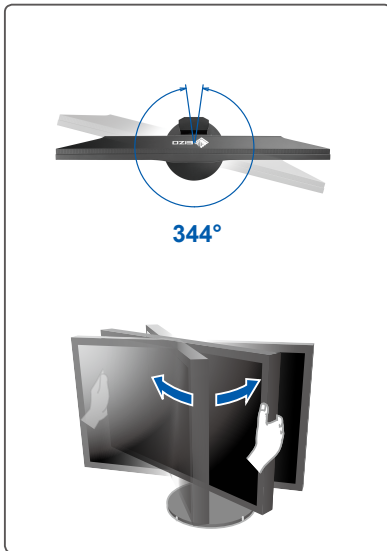

4. Beeldscherm

1. Hoofdschakelaar

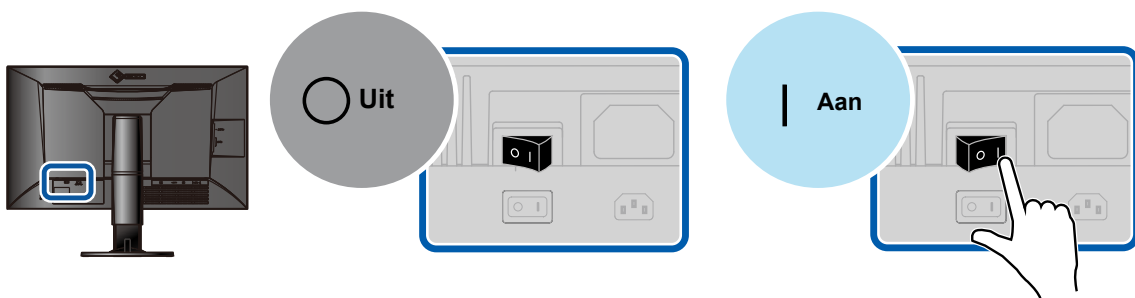

2. Aan/uit-schakelaar

3. Aanbevolen resolutie

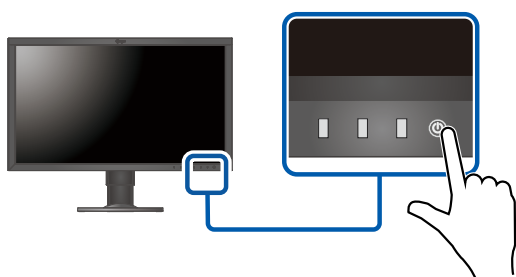

5. Taal

1.

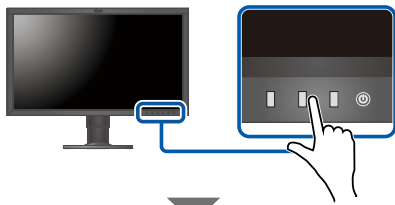

2.

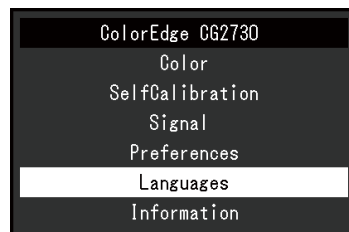
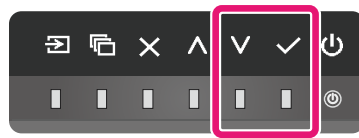

3.

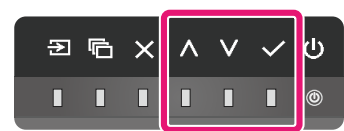

6. Kap



- Zie de gebruikershandleiding van de monitorkap voor meer informatie over de installatie.

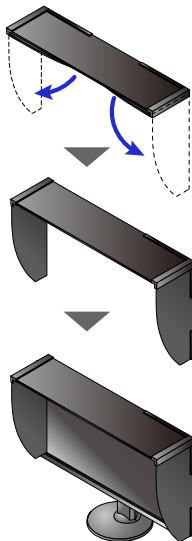

SelfCalibration

Hiermee kunt u een periodieke kalibratie uitvoeren.

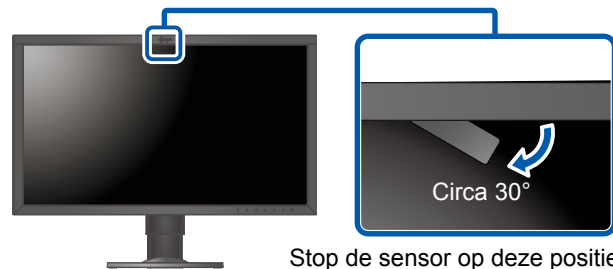

Stop de sensor op deze positie.



- Zie de gebruikershandleiding van de monitor op de cd-rom voor meer informatie over SelfCalibration.

ColorNavigator



- Raadpleeg de "Snelgids" en de gebruikershandleiding van de ColorNavigator (op de cd-rom) voor bedieningsaanwijzingen.

Probleem: geen beeld

Raak  aan op de monitor om deze aan te zetten.

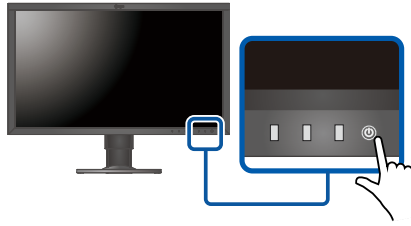

 licht wit op.

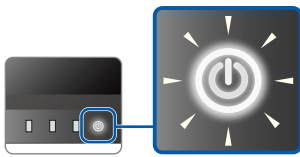

 licht niet op.

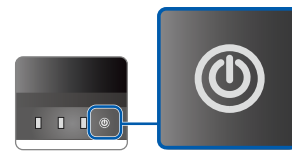

Zet de monitor aan.

- Zet de hoofdschakelaar aan de achterkant van de monitor aan.
- Controleer of het netsnoer goed is aangesloten.

Er verschijnt een melding op het scherm.

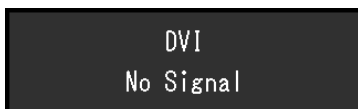

Voer een signaal in.

- Raak  aan om over te schakelen naar de ingang waarop de signaalkabel is aangesloten.^{*1}
- Controleer of de signaalkabel goed is aangesloten.
- De pc staat mogelijk in de slaapstand. Gebruik de muis of het toetsenbord.
- Controleer of de pc aan staat.

Start de pc opnieuw op als bovengenoemde stappen het probleem niet oplossen.

- Zet de hoofdschakelaar aan de achterkant van de monitor aan.
- Start de pc opnieuw op.

Er verschijnt een melding op het scherm.



Er wordt geen correct signaal van de pc ontvangen.

- Start de pc opnieuw op.
- Het grafisch stuurprogramma op de pc werkt mogelijk niet goed. Neem contact op met de computerleverancier of -fabrikant voor meer informatie.

^{*1}

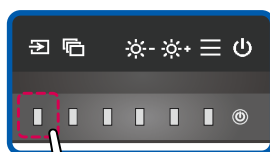

Er verschijnt geen melding op het scherm.

- Verhoog "Brightness" (Helderheid).^{*2}
- Start de pc opnieuw op.

^{*2}

