

User's Manual

ColorEdge[®] CG247

Calibration Color LCD Monitor

Important

Please read PRECAUTIONS, this User's Manual, and the Setup Guide (separate volume) carefully to familiarize yourself with safe and effective usage.

-
- Please refer to the Setup Guide for basic information ranging from connection of the monitor to a PC to using the monitor.
 - The latest User's Manual is available for download from our web site: <http://www.eizoglobal.com>
-



Location of Caution Statement

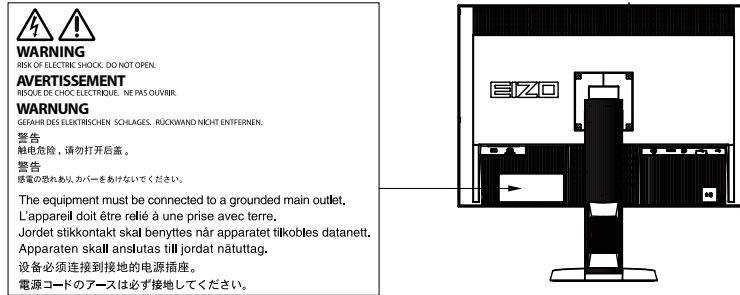

This product has been adjusted specifically for use in the region to which it was originally shipped. If operated outside this region, the product may not perform as stated in the specifications.

No part of this manual may be reproduced, stored in a retrieval system, or transmitted, in any form or by any means, electronic, mechanical, or otherwise, without the prior written permission of EIZO Corporation.

EIZO Corporation is under no obligation to hold any submitted material or information confidential unless prior arrangements are made pursuant to EIZO Corporation's receipt of said information. Although every effort has been made to ensure that this manual provides up-to-date information, please note that EIZO monitor specifications are subject to change without notice.

Notice for this monitor

Aside from general purposes like creating documents, viewing multimedia content, this product is also suited to applications such as graphics creation and digital photo processing, where accurate color reproduction is a priority.

This product has been adjusted specifically for use in the region to which it was originally shipped. If the product is used outside the region, it may not operate as specified in the specifications.

This product may not be covered by warranty for uses other than those described in this manual.

The specifications noted in this manual are only applicable when the following are used:

- Power cords provided with the product
 - Signal cables specified by us
-

Only use optional products manufactured or specified by us with this product.

If you place this product on a lacquer-coated desk, the color may adhere to the bottom of the stand due to the composition of the rubber. Check the desk surface before use.

It takes about 7 minutes (under our measurement conditions) for the performance of electrical parts to stabilize. Please wait 7 minutes or more after the monitor power has been turned on, and then adjust the monitor.

Monitors should be set to a lower brightness to reduce changes in luminosity caused by long-term use and maintain a stable display.

When the screen image is changed after displaying the same image for extended periods of time, an afterimage may appear. Use the screen saver or power save function to avoid displaying the same image for extended periods of time.

Periodic cleaning is recommended to keep the monitor looking new and to prolong its operation lifetime (refer to [“Cleaning” \(page 4\)](#)).

The LCD panel is manufactured using high-precision technology. Although, missing pixels or lit pixels may appear on the LCD panel, this is not a malfunction. Percentage of effective dots: 99.9994% or higher.

The backlight of the LCD panel has a fixed lifetime. When the screen becomes dark or begins to flicker, please contact your local EIZO representative.

Do not press on the panel or edge of the frame strongly, as this may result in display malfunctions, such as interference patterns, etc. If pressure is continually applied to the panel, it may deteriorate or damage your panel. (If the pressure marks remain on the panel, leave the monitor with a black or white screen. The symptom may disappear.)

Do not scratch or press on the panel with any sharp objects, as this may result in damage to the panel. Do not attempt to brush with tissues as this may scratch the panel.

When the monitor is cold and brought into a room or the room temperature goes up quickly, dew condensation may occur on the interior and exterior surfaces of the monitor. In that case, do not turn the monitor on. Instead wait until the dew condensation disappears, otherwise it may cause some damage to the monitor.

Cleaning

Attention

- Chemicals such as alcohol and antiseptic solution may cause gloss variation, tarnishing, and fading of the cabinet or panel, and also quality deterioration of the image.
 - Never use any thinner, benzene, wax, and abrasive cleaner, which may damage the cabinet or panel.
 - Do not allow liquid to enter the clearance between the panel and the panel frame.
-

The stains on the cabinet and panel surface can be removed by using the provided ScreenCleaner.

To use the monitor comfortably

- An excessively dark or bright screen may affect your eyes. Adjust the brightness of the monitor according to the environmental conditions.
- Staring at the monitor for a long time tires your eyes. Take a 10-minute rest every hour.

CONTENTS

Cover	1		
Notice for this monitor	3		
Cleaning	4		
To use the monitor comfortably	4		
CONTENTS	5		
Chapter 1 Introduction	7		
1-1. Features	7		
1-2. Controls and Functions	9		
● Front	9		
● Rear	10		
1-3. EIZO LCD Utility Disk	11		
● Disk contents and software overview	11		
● To use ColorNavigator	11		
1-4. Basic Operations and Functions	12		
● Basic Adjustment menu operations	12		
● Showing Button Guide	13		
● Functions	13		
Chapter 2 Adjusting Screens	15		
2-1. Setting Resolution	15		
● Compatible Resolutions/Formats	15		
● To switch signal formats (Only for HDMI signal input)	16		
● To set the display resolution for the OS	16		
● To select screen size	18		
2-2. Selecting the display mode (color mode)	20		
2-3. Adjusting Color	21		
● To adjust brightness	21		
● To adjust the temperature	22		
● To adjust gamma	23		
● To set color gamut	23		
● To perform advanced adjustments	24		
2-4. Configuring Moving Image Performance	27		
2-5. Specifying Color Space	28		
2-6. Expanding Signal Output Range	28		
● To extend the output range	28		
2-7. Setting HDMI	29		
● To reduce noise	29		
● To select how to display interlace signal	29		
● To setting safe area	30		
Chapter 3 Setting Monitor	31		
3-1. Setting Adjustment Menu	31		
● Selecting the Language	31		
● Setting Orientation	31		
● To change adjustment menu display position	31		
3-2. Skipping Unused Display Modes	32		
3-3. Showing and Hiding the EIZO Logo	32		
3-4. Locking Operation Buttons	32		
3-5. Changing DUE (Digital Uniformity Equalizer) Setting	33		
3-6. Setting Signal Bandwidth	33		
3-7. Reset to default	34		
● To reset the color adjustments	34		
● To reset all adjustments to the default settings	34		
Chapter 4 SelfCalibration	35		
4-1. Setting the Color Mode for Executing SelfCalibration	35		
● CAL mode	35		
● Standard Mode	35		
4-2. Setting Monitor Date and Time	36		
4-3. Setting Calibration Schedule	36		
4-4. Setting the calibration targets	38		
4-5. Executing SelfCalibration	39		
4-6. Checking Adjustment Results	40		
● To check adjustment results with CAL mode	40		
● To check adjustment results with Standard Mode	40		
Chapter 5 Connecting Multiple External Devices	41		
5-1. To switch among input signals	42		
5-2. To set input signal selection	42		
5-3. Skipping Unused Input Signals	42		
5-4. Switching USB Port Automatically	43		
Chapter 6 Power Saving Functions	44		
6-1. Setting Power Save	44		
6-2. Adjusting Brightness of Front Button	45		
6-3. Setting DisplayPort Power Save	45		
Chapter 7 Troubleshooting	46		
7-1. No picture	46		
7-2. Imaging problems	47		
7-3. Other problems	48		
7-4. Built-in calibration sensor and SelfCalibration problems	49		
Chapter 8 Reference	50		
8-1. Attaching the Optional Arm	50		
8-2. Making Use of USB (Universal Serial Bus)	51		
● System Requirement	51		
● Procedure	51		

8-3. Showing Monitor Information.....	52
● Displaying signal information	52
● Displaying Monitor Information	52
8-4. Specifications	53
Chapter 9 Glossary	56
Appendix.....	59
Trademark	59
License / Copyright	59
FCC Declaration of Conformity	60
Hinweise zur Auswahl des richtigen Schwenkarms für Ihren Monitor	61
Hinweis zur Ergonomie :	61
LIMITED WARRANTY.....	62
Recycling Information	71

Chapter 1 Introduction

1-1. Features

- 24.0" wide format LCD
- Wide color gamut (Adobe® RGB coverage: 99%)
- Supports a resolution of 1920 × 1200.
- IPS panel with 178° horizontal and vertical viewing angles
- Frame synchronization mode supported (23.75 - 30.5Hz, 47.5 - 61.0Hz)
- 3 signal input terminals (DVI-D × 1, HDMI × 1, DisplayPort × 1)
 - DisplayPort (applicable to 8 bit and 10 bit)*1
 - HDMI (applicable to 8 bit, 10 bit, and 12 bit)*1, *2
Can handle PC signals in HDMI input
- *1 Not applicable to audio signals.
- *2 The maximum screen display is 10 bits.
- Color mode function
Reproduces a color temperature, gamma, and gamut compliant with the following standard.
 - Broadcasting standards “EBU/REC709/SMPTE-C”
 - Digital cinema standard “DCI”
 - Adobe® RGB / sRGBSee “2-2. Selecting the display mode (color mode)” (page 20)
- Attaching the “Adjustment Certificate”, which describes the factory measurement results of the grayscale and uniformity characteristics for each monitor
- Portrait/Landscape display available (rotate 90° clockwise)
- This product is equipped with a built-in calibration sensor, and supports SelfCalibration in which the monitor executes calibration independently.
See “Chapter 4 SelfCalibration” (page 35)
- The provided Color Management Software “ColorNavigator” enables you to calibrate monitor characteristics and generate color profiles
See “1-3. EIZO LCD Utility Disk” (page 11)
- Power saving function
Suppressing the power consumption reduces the carbon dioxide emissions. This product is equipped with power saving function.
 - 0 W power consumption when the main power is off
Equipped with main power switch.
When the monitor is not required, the power supply can be shut off using the main power switch.
- Displays HDCP (High-bandwidth Digital Protection) protected contents.

Attention

Be careful of the following points when using the built-in calibration sensor.



Do not touch the built-in calibration sensor.

It may reduce the measurement accuracy of the built-in calibration sensor, or result in injury or equipment damage.

Attention

- A high temperature or high humidity environment may affect the measurement accuracy of the built-in calibration sensor. We suggest storing and using the monitor under the following conditions.
 - Temperature 30°C or less
 - Humidity 70% or lessAvoid storing or using the sensor where it may be exposed to direct sunlight.
 - Since adjustment accuracy of the monitor by the built-in sensor may be affected, leave the level of ambient light that enters the sensor part of the built-in sensor unchanged largely while measuring.
 - The use of the monitor hood is recommended.
 - While measuring, do not bring the face or the object close to the monitor, do not look into the sensor.
 - Set the monitor in the environment so that the light outside does not enter the sensor part directly.
-

Note

- This monitor supports both portrait and landscape format. You can change the orientation of the Setting menu when using the monitor screen in vertical display position. (See “[Setting Orientation](#)” (page 31))
 - When using the monitor screen in a portrait position, the graphics board supporting portrait display is required. When placing the monitor in a portrait position, the settings of your graphics board need to be changed. Refer to the User’s Manual of the graphics board for details.
-

1-2. Controls and Functions

● Front

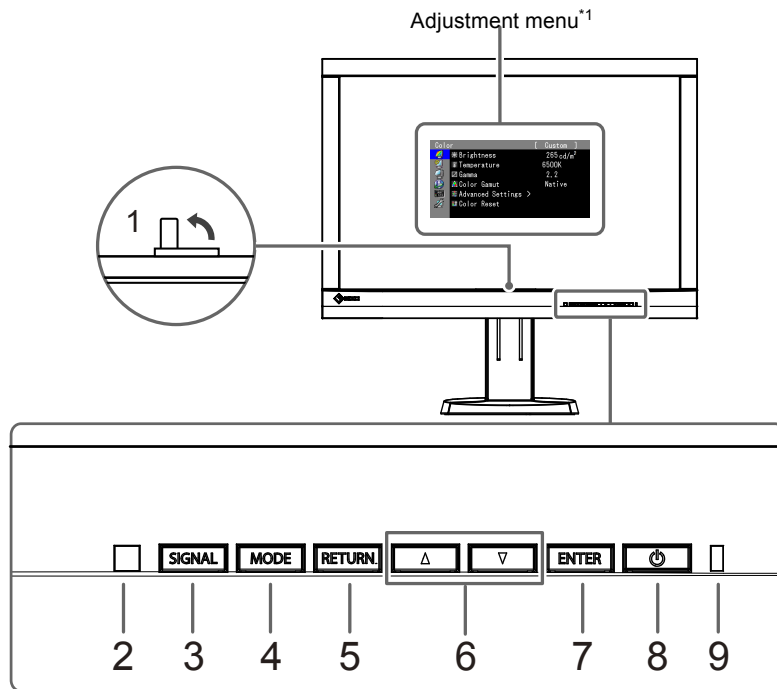

1. Built-in calibration sensor	Executes calibration for an independent monitor. SelfCalibration function (page 35)
2. Ambient Light Sensor	Measures ambient light.
3. SIGNAL button	Switches input signals for display (page 42).
4. MODE button	Changes Color Mode (page 20).
5. RETURN button	Cancels the setting/adjustment and exits the Adjustment menu.
6. ▲▼ buttons	<ul style="list-style-type: none"> Provides the menu selection as well as the adjustment and setting of a function. Displays the Brightness menu (page 21).
7. ENTER button	Displays the Adjustment menu, determines an item on the menu screen, and saves values adjusted (page 12).
8. ⏻ button	Turns the power on or off.
9. Power Indicator	<p>Indicates the monitor's operation status.</p> <p>Blue: Operating</p> <p>Flashing blue (2 times for each): Indicates that recalibration is required if the SelfCalibration schedule (page 36) is set.</p> <p>Orange: Power saving mode</p> <p>OFF: Main power/Power off</p>

*1 See "1-4. Basic Operations and Functions" ([page 12](#)) for how to use.

● Rear

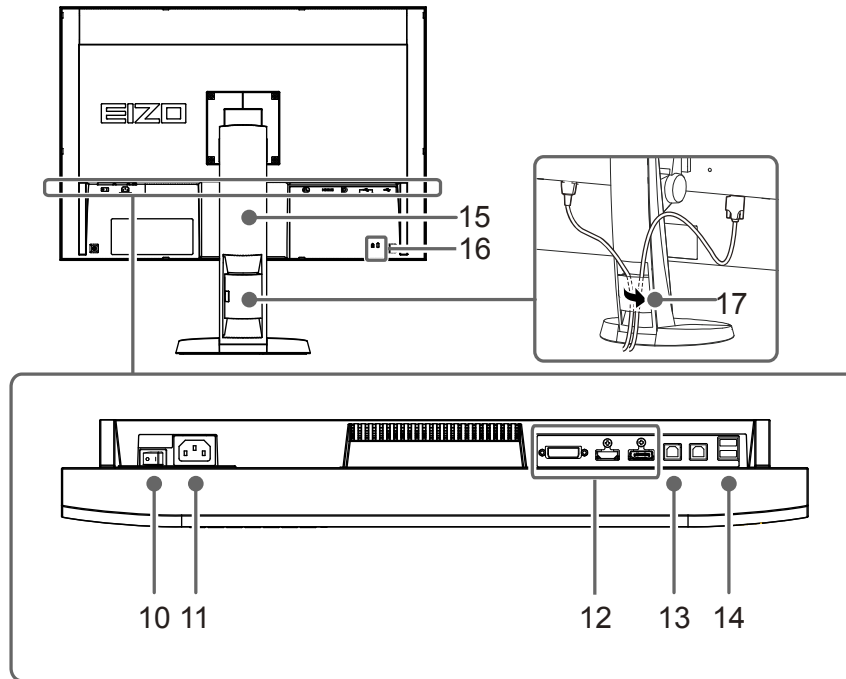

10. Main power switch	Turns the main power on or off.
11. Power connector	Connects the power cord.
12. Input signal connectors	Left: DVI-D connector / Center: HDMI connector / Right: DisplayPort connector
13. USB upstream port	Connects the USB cable to use the software that needs USB connection, or to use USB hub function (page 51).
14. USB downstream port	Connects a peripheral USB device.
15. Stand*2	Used to adjust the height and angle of the monitor screen.
16. Security lock slot	Complies with Kensington's MicroSaver security system.
17. Cable holder	Covers the monitor cables.

*2 An optional arm (or an optional stand) can be attached by removing the stand section (see “8-1. Attaching the Optional Arm” (page 50)).

1-3. EIZO LCD Utility Disk

An “EIZO LCD Utility Disk” (CD-ROM) is supplied with this product. The following table shows the disk contents and the overview of the software programs.

● Disk contents and software overview

The disk includes application software programs for adjustment, and User’s Manual. Refer to “Readme.txt” or the “read me” file on the disk for software startup procedures or file access procedures.

Contents	Overview	Windows	Macintosh
A “Readme.txt” or “read me” file		√	√
ColorNavigator	An application software for calibrating monitor characteristics and generating ICC profiles (for Windows) and Apple ColorSync profiles (for Macintosh). (A PC must be connected to the monitor with the supplied USB cable.)	√	√
Screen adjustment pattern files ^{*1}	Used when adjusting the image of the analog signal input manually.	√	-
User’s Manual of this monitor (PDF file)		√	√

*1 This monitor does not support analog signal input, so these files are not used.

● To use ColorNavigator

Refer to the corresponding User’s Manual on the CD-ROM disk in order to install and use the software. When using this software, you will need to connect a PC to the monitor with the supplied USB cable. For details of the USB cable connection, see “8-2. Making Use of USB (Universal Serial Bus)” (page 51).

1-4. Basic Operations and Functions

● Basic Adjustment menu operations

1. Displaying Adjustment Menu

1. Press ENTER. The Adjustment menu appears.

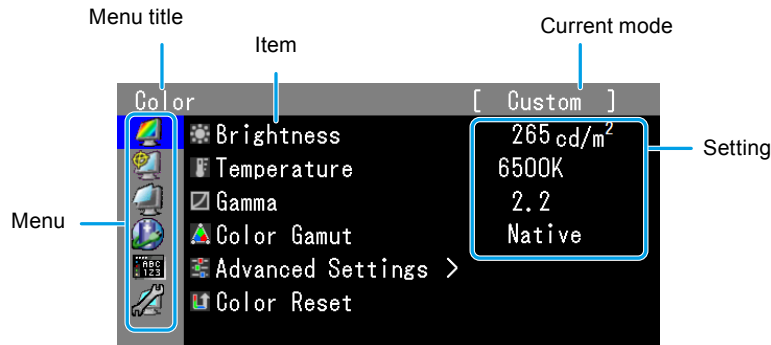

2. Adjusting/Setting

1. Choose a menu to adjust/set with ▲▼, and then press ENTER.

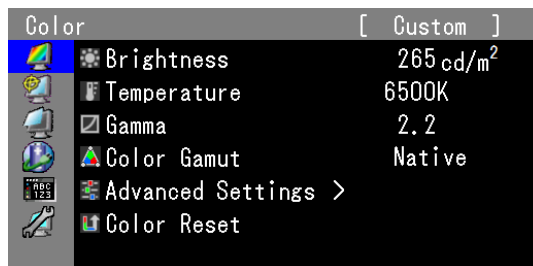

2. Choose an item to adjust/set with ▲▼, and then press ENTER.

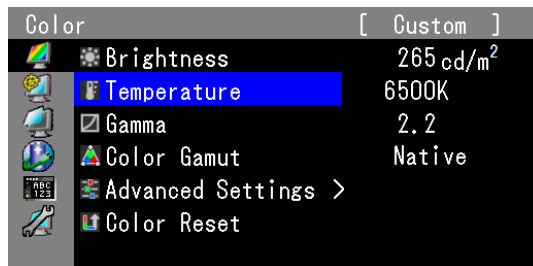

3. Adjust/set the selected item with ▲▼, and then press ENTER.

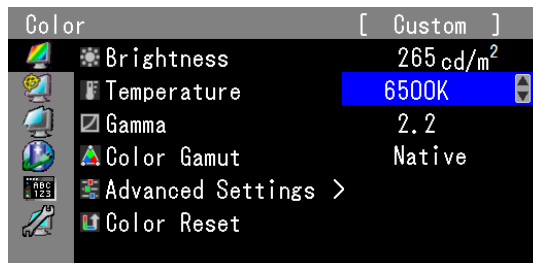

3. Exiting



1. Press RETURN a few times. The Adjustment menu finishes.

● Showing Button Guide

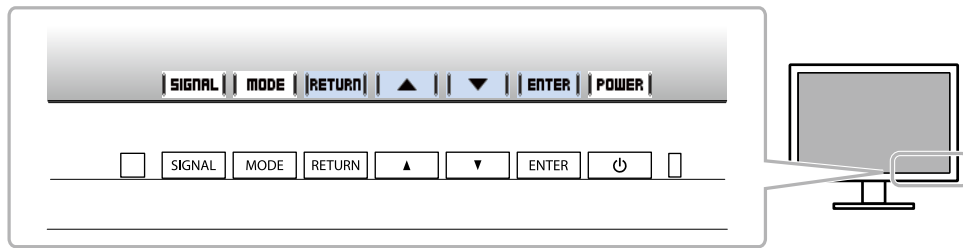
When you press the front buttons (except the  button), the button guide appears next to the button.

































Note

- The button guide will continue to appear while the Adjustment menu or Mode menu is showing.
- The contents of the button guide will differ depending on the selected menu or status.
- In CAL mode, the brightness cannot be adjusted even though the button guide is displayed above the  and  buttons.

● Functions

The following table shows the menus for adjustment and setting items of each menu.

Main Menu	Item	Reference	
Color (Standard Mode)* ¹ 	 Brightness	"2-3. Adjusting Color" (page 21)	
	 Temperature		
	 Gamma		
	 Color Gamut		
	 Advanced Settings		 Hue
			 Saturation
			 Clipping
			 Gain
			 Black Level
		 6 Colors	
 Color Reset	"3-7. Reset to default" (page 34)		
Color (CAL Mode)* ² 	 Target	"4-1. Setting the Color Mode for Executing SelfCalibration" (page 35)	
	 SelfCalibration		
	 Brightness		"4-4. Setting the calibration targets" (page 38)
	 White Point		
	 Color Gamut		
	 Gamut Settings	 Gamma	
		 Result	"4-6. Checking Adjustment Results" (page 40)
		 Calibration Result	
 Ambient Light	 Color Reset	"3-7. Reset to default" (page 34)	

SelfCalibration 	Execute	"4-5. Executing SelfCalibration" (page 39)	
	Standard Mode	SelfCalibration	"4-1. Setting the Color Mode for Executing SelfCalibration" (page 35)
		Result	"4-6. Checking Adjustment Results" (page 40)
	Settings	Schedule	"4-3. Setting Calibration Schedule" (page 36)
		Clock Adjustment	"4-2. Setting Monitor Date and Time" (page 36)
Screen 	Screen Size	"To select screen size" (page 18)	
	Overdrive	"2-4. Configuring Moving Image Performance" (page 27)	
	Color Space	"2-5. Specifying Color Space" (page 28)	
	Input Range	"2-6. Expanding Signal Output Range" (page 28)	
	HDMI Settings*3	Noise Reduction	"2-7. Setting HDMI" (page 29)
		Film detection	
		Safe Area Marker	
		Safe Area Size	
Boder Color			
Power Manager 	Power Save	"6-1. Setting Power Save" (page 44)	
	Indicator	"6-2. Adjusting Brightness of Front Button" (page 45)	
Menu Settings 	Language	"Selecting the Language" (page 31)	
	Orientation	"Setting Orientation" (page 31)	
	Menu Position	"To change adjustment menu display position" (page 31)	
Tools 	Input Selection	"5-2. To set input signal selection" (page 42)	
	Input Skip	"5-3. Skipping Unused Input Signals" (page 42)	
	Mode Skip	"3-2. Skipping Unused Display Modes" (page 32)	
	USB Selection	"5-4. Switching USB Port Automatically" (page 43)	
	Signal Info	"8-3. Showing Monitor Information" (page 52)	
	Monitor info		
	All Reset	"3-7. Reset to default" (page 34)	

*1 Functions available for adjustment and setting in Standard Mode (page 20) are displayed.

*2 Functions available for adjustment and setting in CAL Mode are displayed.

*3 This function is available with HDMI signal input.

Chapter 2 Adjusting Screens

2-1. Setting Resolution

● Compatible Resolutions/Formats

The monitor supports the following resolutions.

When using PC signal input (DVI-D, DisplayPort, HDMI: PC*1)

Resolution	Vertical scan frequency
640 x 480	60 Hz
720 x 400	70 Hz
800 x 600	60 Hz
1024 x 768	60 Hz
1280 x 960	60 Hz
1280 x 1024	60 Hz
1600 x 1200	60 Hz
1680 x 1050	60 Hz
1920 x 1080	60 Hz
1920 x 1200*2	60 Hz

*1 When displaying PC signals by HDMI signal input, change the monitor's setting in advance (see ("To switch signal formats (Only for HDMI signal input)" (page 16)).

*2 Recommended resolution

When using Video signal input

Formats	Vertical scan frequency	Resolution	Scan Type	DVI	DisplayPort	HDMI	
						Video*1	PC*2
480p	59.94 Hz / 60 Hz	640×480	Progressive	√*3	√*3	√	√*3
480i	59.94 Hz / 60 Hz	720×480	Interlace	-	-	√	-
480p	59.94 Hz / 60 Hz	720×480	Progressive	-	√*3	√	-
576i	50 Hz	720×576	Interlace	-	-	√	-
576p	50 Hz	720×576	Progressive	-	-	√	-
720p	50 Hz	1280×720	Progressive	√*3	√*3	√	√*3
720p	59.94 Hz / 60 Hz	1280×720	Progressive	√*3	√*3	√	√*3
1080p	23.976 Hz / 24 Hz	1920×1080	Progressive	√*3	√*3	√	√*3
1080p	25 Hz	1920×1080	Progressive	√*3	√*3	√	√*3
1080p	29.97 Hz / 30 Hz	1920×1080	Progressive	√*3	√*3	√	√*3
1080i	50 Hz	1920×1080	Interlace	√*3	√*3	√	√*3
1080p	50 Hz	1920×1080	Progressive	√*3	√*3	√	√*3
1080i	59.94 Hz / 60 Hz	1920×1080	Interlace	√*3	√*3	√	√*3
1080p	59.94 Hz / 60 Hz	1920×1080	Progressive	√*3	√*3	√	√*3

*1 The color difference signal is supported.

*2 Change the monitor's setting in advance.

*3 The output device must be defined. Refer to the User's Manual of the output device for further details.

● To switch signal formats (Only for HDMI signal input)

The monitor's displayable resolution can be changed. Use this when displaying PC signals by HDMI signal input.

Adjustable Range

Video / PC

Procedure

1. Press **⏻** to turn off the monitor.
2. Holding **MODE** down, press **⏻** for at least two seconds to turn on the monitor.
The "Optional Settings" menu appears.
3. Choose "Signal Selection" from "Optional Settings", and press **ENTER**.
4. Choose the input signal to set with **▲** or **▼**, and press **ENTER**.
5. Select "Signal Format" with the selected input signal and press **ENTER**.
6. Switch the signal format with **▲** or **▼**.
7. Select "Finish" with **▲** or **▼**.
8. Press **ENTER**.

● To set the display resolution for the OS

When you connect the monitor to the PC and find that the resolution is improper, or when you want to change the resolution, follow the procedure below.

Windows 10

1. Right-click the mouse anywhere on the desktop except on icons.
2. From the displayed menu, click "Display Settings".
3. On the "Customize your display" dialog box, click "Advanced display settings".
4. Select a monitor, then choose a resolution from the "Resolution" pull-down menu.
5. Click the "Apply" button.
6. When a confirmation dialog box is displayed, click "Keep changes".

Windows 8.1 / Windows 7

1. For Windows 8.1, click the "Desktop" tile on the Start Screen to display the desktop.
2. Right-click the mouse anywhere on the desktop except for icons.
3. From the displayed menu, click "Screen resolution".
4. On the "Screen Resolution" dialog box, select the monitor.
5. Click "Resolution" to select the desired resolution.
6. Click the "OK" button.
7. When a confirmation dialog box is displayed, click "Keep changes".

Windows Vista

1. Right-click the mouse anywhere on the desktop except for icons.
2. From the displayed menu, click “Personalize”.
3. On the “Personalization” window, click “Display Settings”.
4. On the “Display Settings” dialog box, select the “Monitor” tab and select desired resolution in the “Resolution” field.
5. Click the “OK” button.
6. When a confirmation dialog box is displayed, click “Yes”.

Windows XP

1. Right-click the mouse anywhere on the desktop except for icons.
2. From the displayed menu, click “Properties”.
3. When the “Display Properties” dialog box is displayed, click the “Settings” tab and select desired resolution for “Screen resolution” under “Display”.
4. Click the “OK” button to close the dialog box.

OS X Mountain Lion (10.8) and later

1. Select “System Preferences” from the Apple menu.
2. When the “System Preferences” dialog box is displayed, click “Displays”.
(For Mac OS X Mountain Lion (10.8), click “Displays” for “Hardware”.)
3. On the displayed dialog box, select the “Display” tab, then choose “Change” for “Resolutions”.
4. The list of selectable resolutions is displayed. Select the desired resolution.
If the desired resolution is not displayed in the list, hold down the Option key and select “Change”.
5. Your selection will be reflected immediately. When you are satisfied with the selected resolution, close the window.

Mac OS X 10.7

1. Select “System Preferences” from the Apple menu.
2. When the “System Preferences” dialog box is displayed, click “Displays” for “Hardware”.
3. On the displayed dialog box, select the “Display” tab and select desired resolution in the “Resolutions” field.
4. Your selection will be reflected immediately. When you are satisfied with the selected resolution, close the window.

● To select screen size

The image with the resolution other than the recommended resolution is displayed in full screen automatically. You can change the screen size by using the “Screen Size” function from “Screen”.

When using PC signal input

Settings	Function
Full	Displays an image in full screen. Images are distorted in some cases because the vertical rate is not equal to the horizontal rate.
Enlarged	Displays an image in full screen. In some cases, a blank horizontal or vertical border appears to equalize the vertical rate and the horizontal rate.
Normal	Displays images with the specified resolution.

Example: Image size 1280×1024

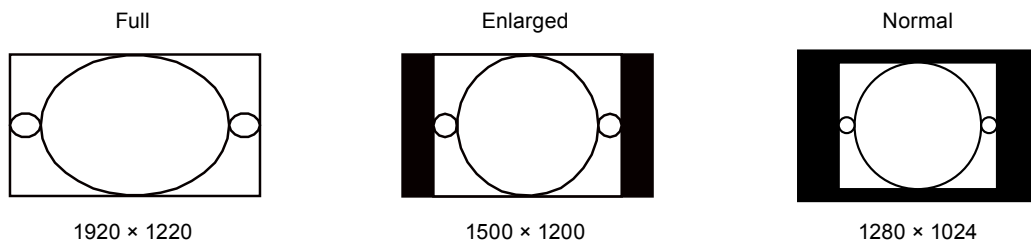

Procedure

1. Choose “Screen” from the Adjustment menu, and press ENTER.
2. Choose “Screen Size” from “Screen”, and press ENTER.
3. Select “Full”, “Enlarged”, or “Normal” with ▲ or ▼.
4. Press ENTER to exit.

When using video signal input

● When displaying HD signals (720p, 1080i, 1080p)

Settings	Function
Enlarged	Images are enlarged to full screen without changing the aspect ratio. Blank borders may appear at the top and bottom of the screen to maintain the aspect ratio.
Dot by Dot	Displays images with the specified resolution.

Example: 720p

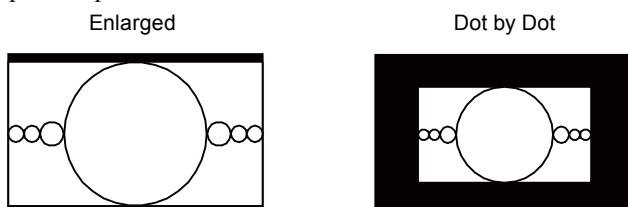

Procedure

1. Choose “Screen” from the Adjustment menu, and press ENTER.
2. Choose “Screen Size” from “Screen”, and press ENTER.
3. Select “Enlarged”, or “Dot by Dot” with ▲ or ▼.
4. Press ENTER to exit.

● When displaying SD signals (640x480, 480i, 480p, 576i, 576p)

Settings	Function
Auto	The monitor automatically changes the screen size according to the aspect ratio sent from the auto input signal.
4:3	Displays images in a 4:3 format screen. Black bars appear on both sides of the screen. 16:9 images are horizontally compressed.
Letter Box	Displays 16:9 letterboxed images in full screen. Images other than the letterboxed ones are partly cut on top and bottom.
16:9	Displays the entire 16:9 image in full screen. Black bars appear on the top and bottom of the screen. 4:3 images are horizontally expanded.

Example: 480i/480p (16:9)

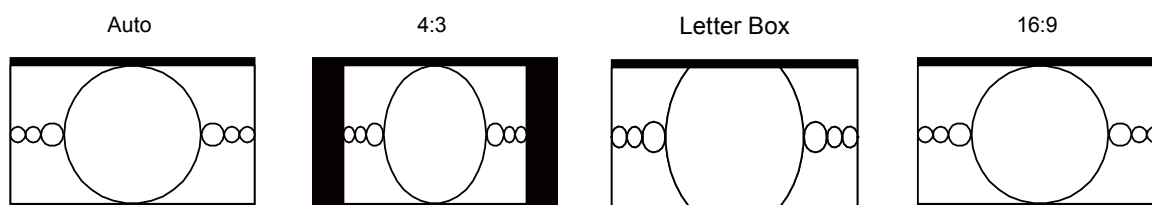

Procedure

1. Choose “Screen” from the Adjustment menu, and press ENTER.
2. Choose “Screen Size” from “Screen”, and press ENTER.
3. Select “Auto”, “4:3”, “Letter Box”, or “16:9” with ▲ or ▼.
4. Press ENTER to exit.

2-2. Selecting the display mode (color mode)

This function allows easy selection of a desired mode according to monitor application.

● Display Modes

Mode	Purpose
Standard Mode	Adjust color using the monitor's Adjustment menu.
1-Custom	Available for the color settings according to your preference.
2-Adobe®RGB	Suitable for color matching with Adobe®RGB compatible peripherals.
3-sRGB	Suitable for color matching with sRGB compatible peripherals.
4-EBU	Suitable for reproducing the color gamut and gamma as set forth by EBU (European Broadcasting Union) standards.
5-REC709	Suitable for reproducing the color gamut and gamma as set forth by the ITU-R Rec. 709 standard.
6-SMPTE-C	Suitable for reproducing the color gamut and gamma as set forth by SMPTE-C standards.
7-DCI	Suitable for reproducing the color gamut and gamma as set forth by DCI standards.
CAL Mode	Adjust the monitor's color using software.
8-CAL1	Displays the screen adjusted by the Color Management Software "ColorNavigator" and SelfCalibration.
9-CAL2	
10-CAL3	

Attention

- Avoid operating any function of the monitor while using ColorNavigator.

Example:

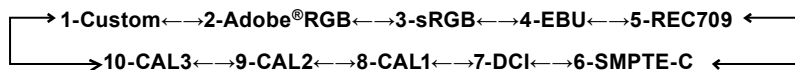
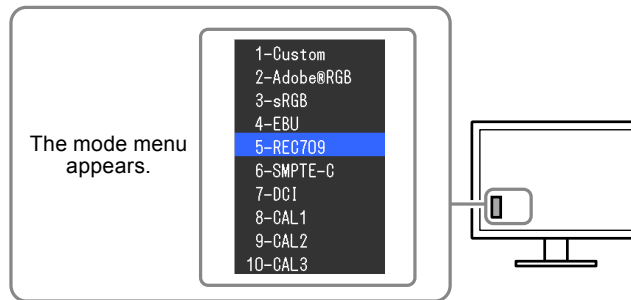

Procedure

1. Press MODE.
The mode menu appears at the bottom left of the screen.
2. The mode among the list is highlighted in turn each time MODE is pressed.
You can switch the mode with ▲ or ▼ while the mode menu is displayed.

Note

- The Adjustment menu and the Mode menu cannot be displayed at the same time.
- You can disable a specific mode to be selected. For more information, see "3-2. Skipping Unused Display Modes" (page 32).

2-3. Adjusting Color

When displaying in Standard Mode, the “Color” menu of the Adjustment menu allows you to set and save independent color adjustments for each mode.

Attention

- It takes about 7 minutes (under our measurement conditions) for the performance of electrical parts to stabilize. Please wait 7 minutes or more after the monitor power has been turned on, and then adjust the monitor.
- The same image may be seen in different colors on multiple monitors due to their monitor-specific characteristics. Make fine color adjustment visually when matching colors on multiple monitors.

Note

- The values shown in “cd/m²”, “K” or “%” are available only as reference.
-

● To adjust brightness

The screen brightness is adjusted by changing the brightness of the backlight (light source from the LCD back panel).

Setting Range

50cd/m² to 350 cd/m²

Procedure

1. Press ▲ or ▼.
The Brightness menu appears.
2. Use ▲ or ▼ for adjustment.
3. Press ENTER to exit.

Attention

- If the entered value cannot be set, the value will appear in magenta. In such a case, change the value.

Note

- Alternatively, you can use “Brightness” under “Color” in the Adjustment menu to adjust it.
-

● To adjust the temperature

The color temperature can be adjusted.

The color temperature is normally used to express the color of “White” and/or “Black” by a numerical value. The value is expressed in degrees “K” (Kelvin).

The screen becomes reddish at a low color temperature, and bluish at a high color temperature, like the flame temperature. The gain preset values are set for each color temperature setting value.

Settings	Purpose
4000K to 10000K	Specify color temperature in units of 100 K
Native	The image is displayed in the preset color of the monitor (Gain: 100% for each RGB).
Adobe®RGB	Change to color temperature in conformance with Adobe®RGB.
sRGB	Change to color temperature in conformance with sRGB.
EBU	Change to color temperature in conformance with EBU.
REC709	Change to color temperature in conformance with REC709.
REC1886	Change to color temperature in conformance with REC1886.
SMPTE-C	Change to color temperature in conformance with SMPTE-C.
DCI	Change to color temperature in conformance with DCI.
User	Displayed when gain is changed.

Procedure

1. Choose “Color” from the Adjustment menu, and press ENTER.
2. Choose “Temperature” from “Color”, and press ENTER.
3. Use ▲ or ▼ for adjustment.
4. Press ENTER to exit.

Note

- “Gain” allows you to perform more advanced adjustment (see [“To adjust gain”](#) (page 26)).
-

● To adjust gamma

Gamma can be adjusted. The brightness of the monitor varies depending on the input signal, however, the variation rate is not proportional to the input signal. To keep the balance between the input signal and the brightness of the monitor is called as “Gamma correction”.

Settings	Purpose
1.6 to 2.7	Set the gamma value.
Adobe®RGB	Set the gamma curve defined by Adobe®RGB.
sRGB	Set the gamma curve defined by sRGB.
EBU	Set the gamma curve defined by EBU.
REC709	Set the gamma curve defined by REC709.
REC1886	Set the gamma curve defined by REC1886.
SMPTE-C	Set the gamma curve defined by SMPTE-C.
DCI	Set the gamma curve defined by DCI.

Procedure

1. Choose “Color” from the Adjustment menu, and press ENTER.
2. Choose “Gamma” from “Color”, and press ENTER.
3. Use ▲ or ▼ for adjustment.
4. Press ENTER to exit.

Note

- The gamma curve can be adjusted to L* by using SelfCalibration or ColorNavigator 6. For details, refer to “4-4. Setting the calibration targets” (page 38) or the ColorNavigator 6 User’s Manual (on the CD-ROM).
- L* is a gamma curve defined in CIE1976 that is perceptually uniform.

● To set color gamut

Set the color reproduction area (color gamut). “Color gamut” is the range of colors that devices such as monitors, digital cameras and printers can express. Various standards are defined.

Settings	Purpose
Native	Display images in the monitor’s original color gamut.
Adobe®RGB	Display images in the color gamut defined by Adobe®RGB.
sRGB	Display images in the color gamut defined by sRGB.
EBU	Display images in the color gamut defined by EBU.
REC709	Display images in the color gamut defined by REC709.
REC1886	Display images in the color gamut defined by REC1886.
SMPTE-C	Display images in the color gamut defined by SMPTE-C.
DCI	Display images in the color gamut defined by DCI.

Procedure

1. Choose “Color” from the Adjustment menu, and press ENTER.
2. Choose “Color Gamut” from “Color”, and press ENTER.
3. Use ▲ or ▼ for adjustment.
4. Press ENTER to exit.

Note

- The method of displaying the defined color gamut outside the normal gamut of the monitor can be set. For more information, see “To set clipping” (page 25).

● To perform advanced adjustments

Make further advanced color adjustments.

To adjust hue

This function allows you to adjust the hue.

Setting Range

-100 to 100

Procedure

1. Choose “Color” from the Adjustment menu, and press ENTER.
2. Choose “Advanced Settings” from “Color”, and press ENTER.
3. Choose “Hue”, and press ENTER.
4. Use ▲ or ▼ for adjustment.
5. Press ENTER to exit.

Attention

- Using this function may make some color gradations unavailable for display.
-

To adjust saturation

This function allows you to adjust color saturation.

Setting Range

-100 to 100

Procedure

1. Choose “Color” from the Adjustment menu, and press ENTER.
2. Choose “Advanced Settings” from “Color”, and press ENTER.
3. Choose “Saturation”, and press ENTER.
4. Use ▲ or ▼ for adjustment.
5. Press ENTER to exit.

Attention

- Using this function may make some color gradations unavailable for display.
-

Note

- The minimum value (-100) changes the screen to monochrome.
-

To set clipping

The method of displaying the defined color gamut outside the normal gamut of the monitor can be set.

Procedure

1. Choose “Color” from the Adjustment menu, and press ENTER.
2. Choose “Advanced Settings” from “Color”, and press ENTER.
3. Choose “Clipping”, and press ENTER.
4. Select “On” or “Off” with ▲ or ▼.

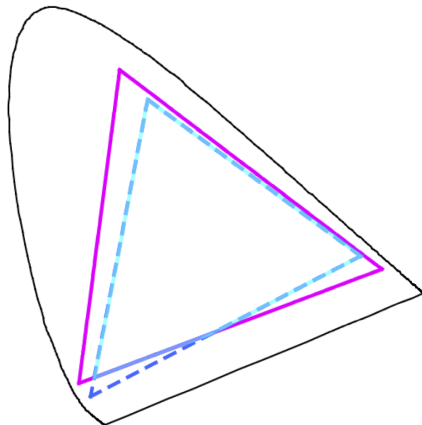

On

Displays colors based on the standard values. The colors outside the gamut of the monitor are clipped.

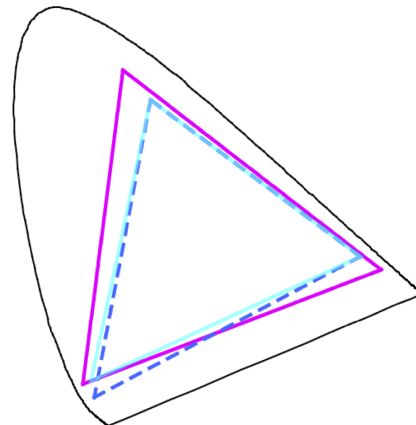

Off

Displays colors with priority on the color gradation rather than the color accuracy. The primary colors outside the gamut of the monitor (blue in the diagram) are adjusted to the colors most similar to those that can be displayed by the monitor.

-
- Color gamut of monitor
 - - - Color gamut defined by standard
 - Color gamut displayed on screen
-

Attention

- This is a conceptual diagram, and does not display the actual color gamut of the monitor.

5. Press ENTER to exit.

Attention

- This function will be disabled if “Native” is selected at “To set color gamut” (page 23).

To adjust gain

The brightness of each color component red, green, and blue is called Gain. You can change the hue of “white” by adjusting gain.

Setting Range

0% to 100%

Procedure

1. Choose “Color” from the Adjustment menu, and press ENTER.
2. Choose “Advanced Settings” from “Color”, and press ENTER.
3. Choose “Gain”, and press ENTER.
4. Choose the color for adjustment from “Red”, “Green”, and “Blue”, and press ENTER.
5. Use ▲ or ▼ for adjustment.
6. Press ENTER to exit.

Attention

- Using this function may make some color gradations unavailable for display.

Note

- The “Temperature” setting invalidates this setting.
 - The value of gain changes with that of color temperature.
 - When gain is changed, the color temperature is changed to “User”.
-

To adjust the brightness and color of black

You can adjust the brightness and chromaticity of black by adjusting the black level of red, green, and blue respectively. Please use a black test pattern or background for adjustment of the black level.

Adjustable Range

0% to 100%

Procedure

1. Choose “Color” from the Adjustment menu, and press ENTER.
2. Choose “Advanced Settings” from “Color”, and press ENTER.
3. Choose “Black Level”, and press ENTER.
4. Choose the color for adjustment from “Red”, “Green”, and “Blue”, and press ENTER.
5. Use ▲ or ▼ for adjustment.
6. Press ENTER to exit.

Note

- To further darken the black when the value of the black level is 0, lower the brightness value.
-

To adjust 6 Colors

The hue, saturation and lightness can be adjusted for each of six colors: Magenta, Red, Yellow, Green, Cyan, and Blue.

Adjustable Range

-100 to 100

Procedure

1. Choose “Color” from the Adjustment menu, and press ENTER.
2. Choose “Advanced Settings” from “Color”, and press ENTER.
3. Choose “6 Colors”, and press ENTER.
4. Choose the color for adjustment from “Magenta”, “Red”, “Yellow”, “Green”, “Cyan”, and “Blue”, and press ENTER.
5. Select “Hue”, “Saturation” or “Lightness”, and press ENTER.
6. Use ▲ or ▼ for adjustment.
7. Press ENTER to exit.

2-4. Configuring Moving Image Performance

This product is equipped with an overdrive function. This function reduces visible afterimages that appear in fast moving images. If noise or afterimage is adversely noticeable when the “Overdrive” setting is set to “On”, change the setting to “Off”.

Default setting: “Off”

Procedure

1. Choose “Screen” from the Adjustment menu, and press ENTER.
2. Choose “Overdrive” from “Screen”, and press ENTER.
3. Select “On” or “Off” with ▲ or ▼.
4. Press ENTER to exit.

2-5. Specifying Color Space

The color space of the input signal can be specified. Set to other than “Auto” if this product cannot display correct color.

Settings	Function
Auto	Identifies the color space of the input signal automatically.
YUV 4:2:2	Converts the color space of the input signal to a YUV 4:2:2 format.
YUV 4:4:4	Converts the color space of the input signal to a YUV 4:4:4 format.
RGB	Converts the color space of the input signal to an RGB format.

Procedure

1. Choose “Screen” from the Adjustment menu, and press ENTER.
2. Choose “Color Space” from “Screen”, and press ENTER.
3. Select “Auto”, “YUV 4:2:2”, “YUV 4:4:4”, or “RGB” with ▲ or ▼.
4. Press ENTER to exit.

Attention

- The setting is required when a DVI device is connected to the monitor (at the HDMI connector port) using the DVI-HDMI conversion connector.
- Even if “Auto” is set, correct color might not be displayed.

Note

- The color space at the DVI input is converted to an RGB format.
- See ”2-6. Expanding Signal Output Range” (page 28) to set the range of input signals.

2-6. Expanding Signal Output Range

Depending on the external device, the black and white levels in the video signal output to the monitor may be restricted. If the signal is displayed on the monitor in its restricted form, the blacks will be faint, the whites dull, and contrast will be reduced. The brightness range of such signals can be extended to match the actual contrast ratio of the monitor.

Settings	Function
Auto	The monitor automatically recognizes the brightness range of input signals and displays images appropriately.
Full	The input signal brightness range is not extended.
Limited (109% White)	The brightness range of the input signal is extended from 16 - 254 (10-bit: 64 - 1019) to 0 - 255 (10-bit: 0 - 1023) for display.
Limited	The brightness range of the input signal is extended from 16 - 235 (10-bit: 64 - 940) to 0 - 255 (10-bit: 0 - 1023) for display.

Procedure

1. Choose “Screen” from the Adjustment menu, and press ENTER.
2. Choose “Input Range” from “Screen”, and press ENTER.
3. Select “Auto”, “Full”, “Limited (109% White)” or “Limited” with ▲ or ▼.

Attention

- When the DVI signal is input, “Auto” cannot be selected.
4. Press ENTER to exit.

2-7. Setting HDMI

● To reduce noise

The small noises that occur in dark images are reduced. Use this function to reduce noise and roughness in images.

Procedure

1. Choose “Screen” from the Adjustment menu, and press ENTER.
2. Choose “HDMI Settings” from “Screen”, and press ENTER.
3. Choose “Noise Reduction”, and press ENTER.
4. Select “On” or “Off” with ▲ or ▼.
5. Press ENTER to exit.

Attention

- Using the Noise Reduction function may deteriorate fine images.
-

● To select how to display interlace signal

The display method can be selected before the interlace signal is displayed.

To identify video images automatically and converting them to suitable images

Signals of 24 frames or 30 frames per second for images such as movies, computer graphics, and animations are automatically identified and the most suitable images are displayed.

Procedure

1. Choose “Screen” from the Adjustment menu, and press ENTER.
2. Choose “HDMI Settings” from “Screen”, and press ENTER.
3. Choose “Film Detection”, and press ENTER.
4. Select “On” or “Off” with ▲ or ▼.
5. Press ENTER to exit.

Attention

- If distorted images are displayed when “Film Detection” is “On”, set “Film Detection” to “Off”.
-

● To setting safe area

The “safe area” is an area in which images can be displayed on any display device. This function displays the safe area to allow you to view the layout of the subtitles and menu windows without using any special software. It enables the positions to be adjusted within the safe area during video editing.

To show or hide

Select whether or not to display the safe area.

Procedure

1. Choose “Screen” from the Adjustment menu, and press ENTER.
2. Choose “HDMI Settings” from “Screen”, and press ENTER.
3. Choose “Safe Area Marker”, and press ENTER.
4. Select “On” or “Off” with ▲ or ▼.
5. Press ENTER to exit.

To set safe area size

The size of the safe area can be set.

Adjustable Range

80% to 99%

Procedure

1. Choose “Screen” from the Adjustment menu, and press ENTER.
2. Choose “HDMI Settings” from “Screen”, and press ENTER.
3. Choose “Safe Area Size”, and press ENTER.
4. The size of the safe area is set with ▲ or ▼.
5. Press ENTER to exit.

To set safe area frame

Procedure

1. Choose “Screen” from the Adjustment menu, and press ENTER.
2. Choose “HDMI Settings” from “Screen”, and press ENTER.
3. Choose “Border Color”, and press ENTER.
4. Choose and set the color for the safety area from “White”, “Red”, “Green”, “Blue”, “Cyan”, “Magenta”, and “Yellow”.
5. Press ENTER to exit.

Chapter 3 Setting Monitor

3-1. Setting Adjustment Menu

The language, orientation, and display position of the Adjustment menu can be set.

● Selecting the Language

This function allows you to select a language for the Adjustment menu and messages.

Selectable languages

English/German/French/Spanish/Italian/Swedish/Japanese/Simplified Chinese/Traditional Chinese

Procedure

1. Choose “Menu Settings” from the Adjustment menu, and press ENTER.
2. Choose “Language” from “Menu Settings”, and press ENTER.
3. Select a language with ▲ or ▼.
4. Press ENTER to exit.

● Setting Orientation

This function allows you to change the orientation of the Adjustment menu.

Procedure

1. Choose “Menu Settings” from the Adjustment menu, and press ENTER.
2. Choose “Orientation” from “Menu Settings”, and press ENTER.
3. Select “Landscape” or “Portrait” with ▲ or ▼.
4. Press ENTER to exit.
5. When selecting “Portrait”, turn the monitor screen 90° in clockwise direction.

Attention

- Be sure that the cables are correctly connected.
- Be sure to turn the monitor screen after pulling up the screen to the uppermost position of the stand and setting the screen tilted upward.

Note

- When using the monitor screen in a portrait position, a graphics board that supports portrait display is required. When placing the monitor in a portrait position, the settings of your graphics board need to be changed. Refer to the User’s Manual of the graphics board for details. Please refer to our web site (<http://www.eizoglobal.com>) as well.
-

● To change adjustment menu display position

You can change the display position of the Adjustment menu.

Procedure

1. Choose “Menu Settings” from the Adjustment menu, and press ENTER.
2. Choose “Menu Position” from “Menu Settings”, and press ENTER.
3. Choose the position with ▲ or ▼.
4. Press ENTER to exit.

3-2. Skipping Unused Display Modes

This function selects / deselects modes that should be skipped. Please use this function if you would like to prevent a mode from being used.

Procedure

1. Choose “Tools” from the Adjustment menu, and press ENTER.
2. Choose “Mode Skip” from “Tools”, and press ENTER.
3. Use ▲ or ▼ to select the mode to change, and press ENTER.
4. Select “-” or “Skip” with ▲ or ▼.
5. Press ENTER to exit.

Attention

- You cannot set all the modes “Skip”. Set at least one mode to “-”.

Note

- Available CAL modes differ depending on each input signal by factory settings.

3-3. Showing and Hiding the EIZO Logo

When the monitor is turned on, the EIZO logo appears on the screen. You can choose to show or hide the display of the EIZO logo.

Procedure

1. Press ⏻ to turn off the monitor.
2. Holding MODE down, press ⏻ for at least two seconds to turn on the monitor.
The “Optional Settings” menu appears.
3. Choose “Logo” from “Optional Settings”, and press ENTER.
4. Select “On” or “Off” with ▲ or ▼, and press ENTER.
5. Select “Finish” with ▲ or ▼.
6. Press ENTER.

3-4. Locking Operation Buttons

This function allows you to lock the settings status to prevent changing them.

Procedure

1. Press ⏻ to turn off the monitor.
2. Holding MODE down, press ⏻ for at least two seconds to turn on the monitor.
The “Optional Settings” menu appears.
3. Choose “Key Lock” from “Optional Settings”, and press ENTER.
4. Choose “Off”, “Menu”, or “All” with ▲ or ▼, and press ENTER.

Settings	Buttons that can be locked
Off(Default setting)	None (All buttons are enabled)
Menu	ENTER button
All	All buttons excluding ⏻

5. Select “Finish” with ▲ or ▼.
6. Press ENTER.

3-5. Changing DUE (Digital Uniformity Equalizer) Setting

This product is equipped with a Digital Uniformity Equalizer function that reduces display unevenness. This DUE setting can be changed.

Settings	Function
Brightness	Prioritizes high brightness and high contrast ratio.
Uniformity	Prioritizes reduction of display unevenness.

Attention

- To change the DUE setting, the adjusted monitor display must be readjusted. Perform the target adjustment and correlation again using ColorNavigator. For details, refer to the ColorNavigator User's Manual (on the CD-ROM).

Procedure

1. Press \mathcal{O} to turn off the monitor.
2. Holding MODE down, press \mathcal{O} for at least two seconds to turn on the monitor.
The "Optional Settings" menu appears.
3. Choose "DUE Priority" from "Optional Settings", and press ENTER.
4. Select "Uniformity" or "Brightness" with \blacktriangle or \blacktriangledown , and press ENTER.
5. Select "Finish" with \blacktriangle or \blacktriangledown .
6. Press ENTER.

3-6. Setting Signal Bandwidth

The range of frequency and detection sensitivity of the change in signal can be switched.

Attention

- This function cannot be used with HDMI input.

Procedure

1. Press \mathcal{O} to turn off the monitor.
2. Holding MODE down, press \mathcal{O} for at least two seconds to turn on the monitor.
The "Optional Settings" menu appears.
3. Choose "Signal Selection" from "Optional Settings", and press ENTER.
4. Choose the input signal to set with \blacktriangle or \blacktriangledown , and press ENTER.
5. Choose "Signal Bandwidth", and press ENTER.
6. Select "Normal", "Wide-1" or "Wide-2" with \blacktriangle or \blacktriangledown , and press ENTER.
7. Select "Finish" with \blacktriangle or \blacktriangledown .
8. Press ENTER.

3-7. Reset to default

The setting values are reset to the default settings.

Attention

- After resetting, you cannot undo the operation.

Note

- Regarding the default setting, see [“Main Default Settings” \(page 54\)](#).
-

● To reset the color adjustments

This function only resets the color adjustment value for the currently selected mode to the default settings.

Procedure

1. Choose “Color” from the Adjustment menu, and press ENTER.
2. Choose “Color Reset” from “Color”, and press ENTER.
3. Select “Execute” with ▲ or ▼.
4. Press ENTER.

● To reset all adjustments to the default settings

This function resets all adjustments to the default settings (except the “Optional Settings” menu and “USB Selection”).

Procedure

1. Choose “Tools” from the Adjustment menu, and press ENTER.
2. Choose “All Reset” from “Tools”, and press ENTER.
3. Select “Execute” with ▲ or ▼.
4. Press ENTER.

Chapter 4 SelfCalibration

This product is equipped with a built-in calibration sensor. The conditions that have been adjusted using ColorNavigator and the measurement device can be maintained.

As the adjustment targets or interval times for SelfCalibration are set in advance using ColorNavigator, the built-in calibration sensor automatically executes regular calibration.

Monitor operation and setting are not necessary when ColorNavigator is used.

If ColorNavigator cannot be run due to the usage environment, SelfCalibration can be executed for an independent monitor.

Note

- The measurement results from the built-in calibration sensor can be correlated with the measurement results from the measurement device in use. For details, refer to the ColorNavigator User's Manual (on the CD-ROM).
 - SelfCalibration can also be executed when there are no computer signals being input.
-

4-1. Setting the Color Mode for Executing SelfCalibration

● CAL mode

Set the setting for CAL mode at "Color" in the Adjustment menu.

Note

- Multiple CAL modes can be enabled for one input signal. For more information, see ["3-2. Skipping Unused Display Modes"](#) (page 32).
-

Procedure

1. Switch to desired color mode.
2. Choose "Color" from the Adjustment menu, and press ENTER.
3. Choose "Target" from "Color", and press ENTER.
The target setting window appears.
4. Choose "SelfCalibration" from the "Target" menu, and press ENTER.
5. Select "On" or "Off" with ▲ or ▼, and press ENTER.
6. Press ENTER to exit.

● Standard Mode

When SelfCalibration is executed in Standard Mode, the monitor's color gamut is updated and each display mode in Standard Mode is adjusted as follows:

- The temperature is adjusted so that it is as close as possible to the specified value.
- The gamut values are adjusted so that they are close to each specified value.
- Information on brightness is updated.

Procedure

1. Choose "SelfCalibration" from the Adjustment menu, and press ENTER.
2. Choose "Standard Mode" from "SelfCalibration", and press ENTER.
The Source adjustment menu appears.
3. Choose "SelfCalibration" from the "Standard Mode" menu, and press ENTER.
4. Select "On" or "Off" with ▲ or ▼, and press ENTER.
5. Press RETURN to exit.

4-2. Setting Monitor Date and Time

Set the monitor date and time.

Note

- When ColorNavigator is started, the date and time are automatically set. For details, refer to the ColorNavigator User's Manual (on the CD-ROM).

Procedure

1. Choose "SelfCalibration" from the Adjustment menu, and press ENTER.
2. Choose "Settings" from "SelfCalibration", and press ENTER.
3. Choose "Clock Adjustment" from "Settings", and press ENTER.
The Clock Adjustment menu appears.
4. Set date with ▲ or ▼, and press ENTER.
5. Set time with ▲ or ▼, and press ENTER.

Attention

- If the main power supply is disconnected for an extended period of time, the clock may need resetting.

4-3. Setting Calibration Schedule

Set the calibration schedule for SelfCalibration.

Procedure

1. Choose "SelfCalibration" from the Adjustment menu, and press ENTER.
2. Choose "Settings" from "SelfCalibration", and press ENTER.
3. Choose "Schedule" from "Settings", and press ENTER.
The schedule setting menu appears.
4. Choose "Starting Time", and press ENTER.
5. Set the "Starting Time" with ▲ or ▼.

Select the timing to execute SelfCalibration upon reaching the time set in the schedule.

Settings	Function
Off	SelfCalibration is not executed.
Power Save	To be executed under any of the following conditions. <ul style="list-style-type: none">• When the monitor is in "Power Save" mode or power is off at the set time.• The monitor shifts to the power saving mode or the power is turned off when the time period set in the schedule has elapsed.
Immediately	SelfCalibration is executed immediately at the set time.

Press RETURN to exit.

6. Choose "Setting Type, and press ENTER.

Select the method for setting the adjustment schedule.

Setting	Function	Setting Example
Type-1	Execute once in every few months.	Execute once a month on Wednesday at 1:00 AM of the first week.
Type-2	Execute once in every few weeks.	Execute once every four weeks on Wednesday at 1:00 AM.
Type-3	Execute when the monitor usage time exceeds the set time.	Execute when the monitor usage time exceeded 200 hours.

Press ENTER to exit.

7. Select the interval for execution

The setting details differ depending on the type of “Setting Type” set.

Type-1

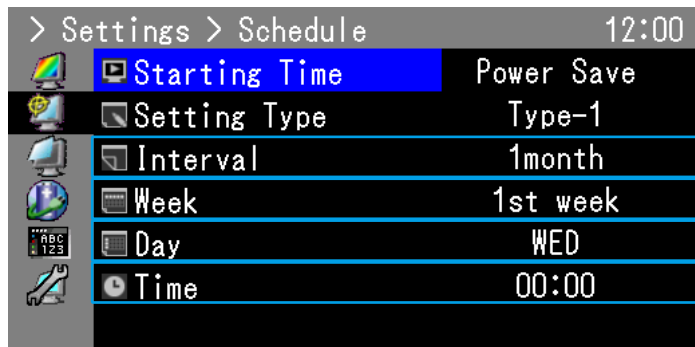

- Set the interval between executions in months. Set within 1 month to 12 months.
- Set the week of the month for execution. Make the setting between the 1st to the 5th week.
- Select the day for execution. Select from SUN/MON/TUE/WED/THU/FRI and SAT.
- Set the time at which SelfCalibration is executed. Set within 0:00 to 23:30.

Note

- If the fifth week is selected but the fifth week doesn't have the selected day, adjustment will be executed on the fourth week.

Type-2

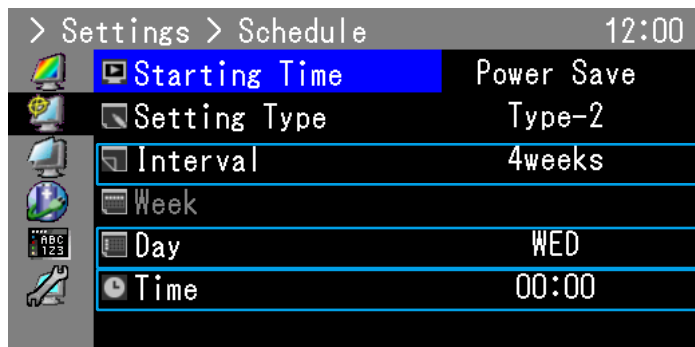

- Set the interval between executions in weeks. Set within 1 week to 5 weeks.
- Select the day for execution. Select from SUN/MON/TUE/WED/THU/FRI and SAT.
- Set the time at which SelfCalibration is executed. Set within 0:00 to 23:30.

Type-3

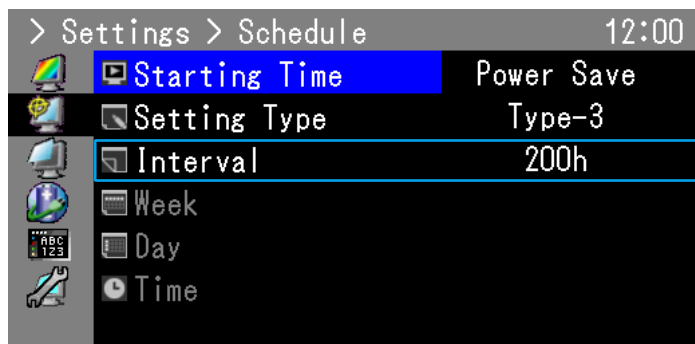

- Set the number of hours of monitor usage to elapse until execution. Set within 50 to 500 hours.

Press ENTER to exit.

8. After completing all settings, press RETURN.

Calibration schedule is set.

Note

- Upon reaching the set timing, the power indicator will blink in blue (quickly twice).

4-4. Setting the calibration targets

In CAL mode, white point, color gamut and gamma can be set as adjustment targets.

Attention

- Adjustment targets will be applied only to the currently displayed CAL mode.

Procedure

1. Choose “Color” from the Adjustment menu, and press ENTER.
2. Choose “Target” from “Color”, and press ENTER.
The target setting window appears.
3. Choose “Brightness”, and press ENTER.
4. Set the target brightness with ▲ or ▼, and press ENTER.
5. Choose “White Point”, and press ENTER.
The white point setting window appears.
 - When setting color coordinates, select “White(x)” and “White(y)” and press ENTER. Then set the respective values. Set within 0.2400 to 0.4500.
 - When specifying color temperature, select “Temperature” and press ENTER.

Settings	Function
4000 K to 10000 K	Specify color temperature in units of 100 K.
Adobe®RGB	Change to color temperature in conformance with Adobe®RGB.
sRGB	Change to color temperature in conformance with sRGB.
EBU	Change to color temperature in conformance with EBU.
REC709	Change to color temperature in conformance with REC709.
REC1886	Change to color temperature in conformance with REC1886.
SMPTE-C	Change to color temperature in conformance with SMPTE-C.
DCI	Change to color temperature in conformance with DCI.

Note

- When color coordinates are changed, the color temperature is changed to “User”.

Press ENTER to exit.

6. Choose “Color Gamut”, and press ENTER.

The color gamut setting window appears. The color gamut defined by each standard can be selected.

Settings	Function
Native	Display images in the monitor’s original color gamut.
Adobe®RGB	Display images in the color gamut defined by Adobe®RGB.
sRGB	Display images in the color gamut defined by sRGB.
EBU	Display images in the color gamut defined by EBU.
REC709	Display images in the color gamut defined by REC709.
REC1886	Display images in the color gamut defined by REC1886.
SMPTE-C	Display images in the color gamut defined by SMPTE-C.
DCI	Display images in the color gamut defined by DCI.

Note

- To set a color gamut other than those specified by each standard, specify the color coordinates of each RGB color at “Gamut Settings”. The “Color Gamut” setting will automatically change to “User” at this time.
- Clipping can be set at “Gamut Settings”. For details on clipping, see (“To set clipping” (page 25)).

7. Choose “Gamma”, and press ENTER.

Settings	Function
1.6-2.7	Set the gamma value.
Adobe®RGB	Set the gamma curve defined by Adobe®RGB.
sRGB	Set the gamma curve defined by sRGB.
EBU	Set the gamma curve defined by EBU.
REC709	Set the gamma curve defined by REC709.
REC1886	Set the gamma curve defined by REC1886.
SMPTE-C	Set the gamma curve defined by SMPTE-C.
DCI	Set the gamma curve defined by DCI.
L*	Set the perceptually uniform gamma curve defined by CIE1976.

Note

- The color gradation adjustment results are reflected and automatically become “Fixed” when adjusted with ColorNavigator 6.

Press ENTER to exit.

8. After completing all settings, press RETURN.

4-5. Executing SelfCalibration

SelfCalibration can be executed manually regardless of the schedule.

Procedure

1. Choose “SelfCalibration” from the Adjustment menu, and press ENTER.
2. Choose “Execute” from “SelfCalibration”, and press ENTER.

The built-in calibration sensor is activated, and SelfCalibration is executed.

Attention

- To execute SelfCalibration, it is necessary to set the calibration details. For more information, see “4-4. Setting the calibration targets” (page 38).
- After selecting “Execute”, aging may be executed before the built-in calibration sensor is executed.

4-6. Checking Adjustment Results

The previous SelfCalibration results can be checked.

● To check adjustment results with CAL mode

Procedure

1. Choose “Color” from the Adjustment menu, and press ENTER.
2. Choose “Result” from “Color”, and press ENTER.
3. Choose “Calibration Result” from “Result”, and press ENTER.

The adjustment result window appears.

Attention

- The measurement results of the ambient light sensor are used to check the difference between the current environmental light level and the level of ambient light when SelfCalibration was executed, and are not reflected in the SelfCalibration results.

Note

- If “Ambient Light” is selected, the current environmental light is also displayed.
 - If the environment in which the product is used is significantly different to the previous environment, the ambient light measurement results may differ greatly between the previous calibrations and current calibrations.
-

● To check adjustment results with Standard Mode

1. Choose “SelfCalibration” from the Adjustment menu, and press ENTER.
2. Choose “Standard Mode” from “SelfCalibration”, and press ENTER.
3. Choose “Result” from “Standard Mode”, and press ENTER.

The adjustment result window appears.

4. Choose “Ambient Light” from “Result”, and press ENTER.

The measurement result screen of ambient light is displayed.

Chapter 5 Connecting Multiple External Devices

The product has multiple connections to external devices and allows you to switch to one of the connections for display.

Connection examples

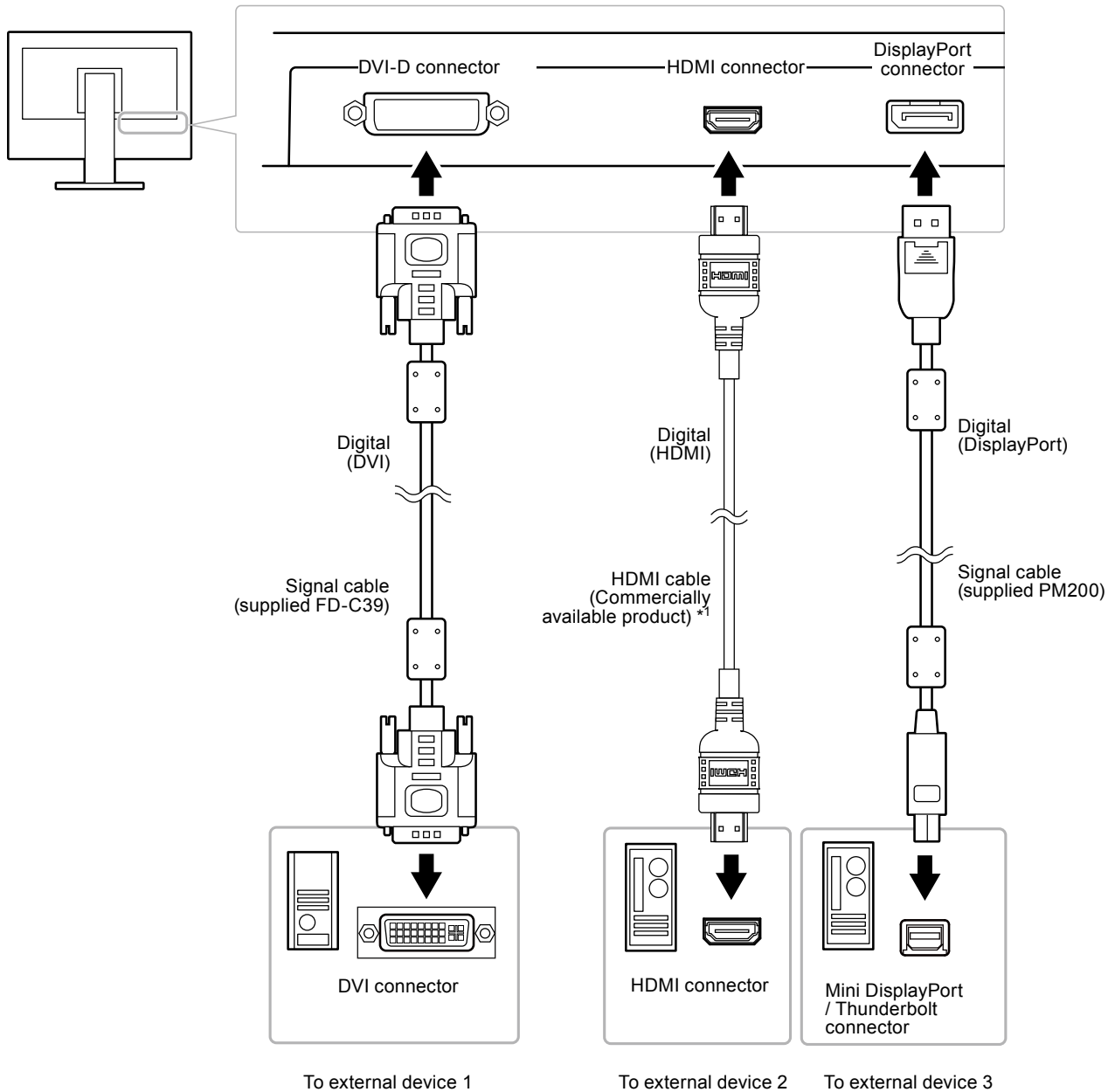

*1 Use a product able to handle High Speed .

5-1. To switch among input signals

The input signal switches each time SIGNAL is pressed.

When the signal is switched, the active input port name appears at the top right corner of the screen.

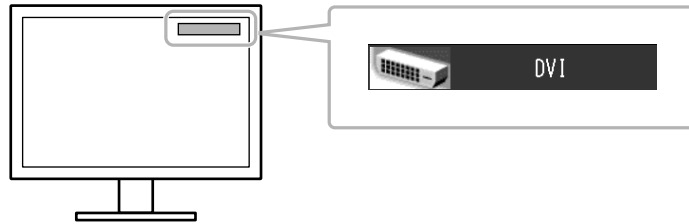

5-2. To set input signal selection

Settings	Function
Auto	The monitor recognizes the connector through which signals are input. When an external device enters the power saving mode, the monitor automatically displays another signal.
Manual	The monitor displays the signal from the selected connector despite the signal input. Select the input signal for display using the SIGNAL operation button.

Procedure

1. Choose “Tools” from the Adjustment menu, and press ENTER.
2. Choose “Input Selection” from “Tools”, and press ENTER.
3. Select “Auto” or “Manual” with ▲ or ▼.
4. Press ENTER to exit.

Note

- When “Auto” is selected for “Input Selection”, the monitor’s power saving function works only when all external devices are in the power saving mode.

5-3. Skipping Unused Input Signals

This function allows skipping of the set input signals when the input signals are switched.

Procedure

1. Choose “Tools” from the Adjustment menu, and press ENTER.
2. Choose “Mode Skip” from “Tools”, and press ENTER.
3. Use ▲ or ▼ to select the mode to change, and press ENTER.
4. Select “-” or “Skip” with ▲ or ▼.
5. Press ENTER to exit.

Attention

- You cannot set all the modes “Skip”. Set at least one mode to “-”.

5-4. Switching USB Port Automatically

This function allows the input signal to link the USB upstream port when one monitor is connected to two PCs. This can switch the USB port automatically according to the switch of the input signal. To calibrate one monitor using two PCs, the USB cables do not need to be connected again. USB devices such as the mouse and keyboard connected to one monitor can be used with two PCs.

Attention

- A cap is attached to USB-2 at shipment. Remove the cap when using USB-2.
- To switch the USB port to be used, two USB cables are required. Prepare cables.
- If a storage device such as a USB memory is connected to the monitor, remove the device before changing the setting. Otherwise, data may be lost or damaged.
- The key arrangement of the keyboard cannot be changed.

Note

- When the “Input Selection” function is set to “Auto”, the USB port automatically switches according to the switch of the input signal.
 - The USB downstream port can be operated using the currently monitored PC.
-

Procedure

1. Choose “Tools” from the Adjustment menu, and press ENTER.
2. Choose “USB Selection” from “Tools”, and press ENTER.
3. Choose the input signal to set with ▲ or ▼, and press ENTER.
4. Select “USB-1” or “USB-2” with ▲ or ▼.
5. Press ENTER to exit.

Chapter 6 Power Saving Functions

6-1. Setting Power Save

This function allows you to specify whether to set the monitor in the power saving mode, depending on the state of an external device connected to it. When the monitor has shifted to the power saving mode, the images on the screen are not displayed.

Attention

- Turning off the main power switch or unplugging the power cord completely shuts off power supply to the monitor.
- When the monitor is in power saving mode, devices connected to the USB downstream port will still work. Therefore, the power consumption of the monitor varies with the connected devices even in the power saving mode.
- Five seconds before the monitor enters the power saving mode, it displays a preliminary message.

Procedure

1. Choose “PowerManager” from the Adjustment menu, and press ENTER.
2. Choose “Power Save” from “PowerManager”, and press ENTER.
3. Select “On” or “Off” with ▲ or ▼.
4. Press ENTER to exit.

Power Saving System

When the external device connected is a PC

At DVI signal input

This monitor complies with the “DVI DMPM” standard.

At DisplayPort signal input

This monitor complies with the “DisplayPort Standard V1.1a”.

PC	Monitor	Power Indicator
On	Operating mode	Blue
Power saving mode	Power saving mode	Orange

When the external device connected is not a PC

Ext. Device	Monitor	Power Indicator
On	Operating mode	Blue
Power saving mode	Power saving mode	Orange

Exiting the power saving mode

If the monitor receives input, it automatically exits the power saving mode and returns to the normal display mode.

6-2. Adjusting Brightness of Front Button

The brightness of the power button (blue) and the control button (white) when the screen is displayed can be set. (Default setting: 4)



Procedure

1. Choose “PowerManager” from the Adjustment menu, and press ENTER.
2. Choose “Indicator” from “PowerManager”, and press ENTER.
3. Select the indicator brightness “Off” or in the range from 1 to 7 with ▲ or ▼ as desired.
4. Press ENTER to exit.

6-3. Setting DisplayPort Power Save

If the PC is connected to the DisplayPort connector, and when the power is turned on or off or when the monitor recovers from power saving mode, window or icon positions may be shifted. If that occurs, set this function to “Off”.

Procedure

1. Press  to turn off the monitor.
2. Holding MODE down, press  for at least two seconds to turn on the monitor.
The “Optional Settings” menu appears.
3. Choose “DP Power Save” from “Optional Settings”, and press ENTER.
4. Select “On” or “Off” with ▲ or ▼, and press ENTER.
5. Select “Finish” with ▲ or ▼.
6. Press ENTER.

Chapter 7 Troubleshooting

If a problem still remains after applying the suggested remedies, contact your local EIZO representative.

7-1. No picture

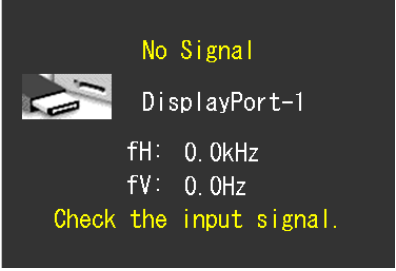
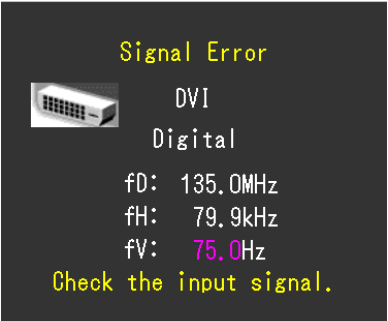
Problem	Possible cause and remedy
<p>1. No picture</p> <ul style="list-style-type: none"> Power indicator does not light. Power indicator is lighting blue. Power indicator is lighting orange. Power indicator is flashing orange and blue. 	<ul style="list-style-type: none"> Check whether the power cord is connected properly. Press . Turn the main power switch on. Turn off the main power, and then turn it on again a few minutes later. Increase "Brightness" and/or "Gain" in the Adjustment menu (see "2-3. Adjusting Color" (page 21)). Switch the input signal with SIGNAL. Operate the mouse or keyboard. Check whether the PC is turned on. Turn off the main power on the rear side of the monitor, and then turn it on again. The device that is connected using DisplayPort / HDMI have a problem. Solve the problem, turn off the monitor, and then turn it on again. Refer to the User's Manual of the output device for further details.
<p>2. The message below appears.</p> <ul style="list-style-type: none"> This message appears when no signal is input. Example:  <ul style="list-style-type: none"> The message shows that the input signal is out of the specified frequency range. (Such signal frequency is displayed in magenta.) Example:  <p>fD: Dot Clock fH: Horizontal Scan Frequency fV: Vertical scan frequency</p>	<p>This message appears when the signal is not input correctly even when the monitor functions properly.</p> <ul style="list-style-type: none"> The message shown left may appear, because some PCs do not output the signal soon after power-on. Check whether the PC is turned on. Check whether the signal cable is connected properly. Switch the input signal with SIGNAL. Turn off the main power on the rear side of the monitor, and then turn it on again. Check whether the PC is configured to meet the resolution and vertical scan frequency requirements of the monitor (see "Compatible Resolutions/Formats" (page 15)). Reboot the PC. Select an appropriate setting using the graphics boards utility. Refer to the User's Manual of the graphics board for details.

7-2. Imaging problems

Problem	Possible cause and remedy
1. The screen is too bright or too dark.	<ul style="list-style-type: none"> Use "Brightness" in the Adjustment menu to adjust it. (The LCD monitor backlight has a limited life span.) When the screen becomes dark or begins to flicker, contact your local EIZO representative.)
2. Characters are blurred.	<ul style="list-style-type: none"> Check whether the PC is configured to meet the resolution and vertical scan frequency requirements of the monitor (see "Compatible Resolutions/Formats" (page 15)).
3. Afterimages appear.	<ul style="list-style-type: none"> Afterimages are particular to LCD monitors. Avoid displaying the same image for a long time. Use the screen saver or power saving function to avoid displaying the same image for extended periods of time.
4. Green/red/blue/white dots or defective dots remain on the screen.	<ul style="list-style-type: none"> This is due to LCD panel characteristics and is not a failure.
5. Interference patterns or pressure marks remain on the screen.	<ul style="list-style-type: none"> Leave the monitor with a white or black screen. The symptom may disappear.
6. Noise appears on the screen.	<ul style="list-style-type: none"> In the Adjustment menu, set "Overdrive" to "Off" (see "2-4. Configuring Moving Image Performance" (page 27)). When entering the signals of HDCP, the normal images may not be displayed immediately.
7. (DisplayPort input) Display position of the windows changes.	<ul style="list-style-type: none"> When the signal is switched, the position of the window may be changed. In the Adjustment menu, set "DP Power Save" to "Off" (see "6-3. Setting DisplayPort Power Save" (page 45)).
8. (DisplayPort or HDMI input) The color shown on the display is not correct.	<ul style="list-style-type: none"> Use "Screen" - "Color Space" under the Adjustment menu to adjust it (see "2-5. Specifying Color Space" (page 28)). For HDMI signal input, change the "Signal Format" setting (see "To switch signal formats (Only for HDMI signal input)" (page 16)).
9. An image does not display on the entire screen.	<ul style="list-style-type: none"> Change the "Screen Size" setting (see "To select screen size" (page 18)).

7-3. Other problems

Problem	Possible cause and remedy
1. The adjustment menu does not appear.	<ul style="list-style-type: none"> • Check whether the operation lock function works (see “3-4. Locking Operation Buttons” (page 32)). • Operation buttons are locked when ColorNavigator is running. Exit the software.
2. No mode menu is displayed.	<ul style="list-style-type: none"> • Check whether the operation lock function works (see “3-4. Locking Operation Buttons” (page 32)). • Operation buttons are locked when ColorNavigator is running. Exit the software.
3. The monitor connected with the USB cable is not detected. / USB devices connected to the monitor does not work.	<ul style="list-style-type: none"> • Check whether the USB cable is connected correctly (see “8-2. Making Use of USB (Universal Serial Bus)” (page 51)). • Check the “Tools” – “USB Selection” settings under the Setting menu (see “5-4. Switching USB Port Automatically” (page 43)). • Change the USB port to another one. If the PC or peripheral devices works correctly by changing the USB port, contact your local EIZO representative. (Refer to the manual of the PC for details.) • Reboot the PC. • If the peripheral devices work correctly when the PC and peripheral devices are connected directly, please contact your local EIZO representative. • Check whether the PC and OS are USB compliant. (For USB compliance of the respective devices, consult their manufacturers.) • Check the PC’s BIOS setting for USB when using Windows. (Refer to the manual of the PC for details.)
4. Audio is not output.	<ul style="list-style-type: none"> • This monitor does not support the HDMI/DisplayPort audio signals.

7-4. Built-in calibration sensor and SelfCalibration problems

Problem	Possible cause and remedy
1. The built-in calibration sensor does not come out/stays out.	<ul style="list-style-type: none"> Turn off the main power, and then turn it on again a few minutes later.
2. SelfCalibration cannot be executed.	<ul style="list-style-type: none"> Check whether the date and time are set correctly (see “4-2. Setting Monitor Date and Time” (page 36)). Check whether the mode is set (see “4-3. Setting Calibration Schedule” (page 36)). Check whether the calibration targets are set correctly (see “4-4. Setting the calibration targets” (page 38)). Set the SelfCalibration target using ColorNavigator.
3. SelfCalibration failure	<ul style="list-style-type: none"> Refer to the error code table. If an error code that does not appear in the error code table is displayed, contact your local EIZO representative.

Error Code Table

Error Code	Description
0011	<ul style="list-style-type: none"> Calibration cannot be performed because the target brightness is too low. Increase the target brightness, and then execute SelfCalibration again.
0013	<ul style="list-style-type: none"> There may be a problem with the target value setting. Recheck the target values of the Color Gamut. It is possible that measurement could not be performed correctly. <ul style="list-style-type: none"> Ensure that the built-in calibration sensor is not exposed to strong light such as direct sunlight. Try executing correlation using ColorNavigator 6.
0014	<ul style="list-style-type: none"> The target brightness may be too high. Lower the target brightness, and then execute SelfCalibration again. Calibration may have failed. Ensure that the built-in calibration sensor is not exposed to strong light such as direct sunlight, and then execute SelfCalibration again.
0030 0032	<ul style="list-style-type: none"> The built-in calibration sensor may have failed. Contact your local EIZO representative.
0033	<ul style="list-style-type: none"> It is possible that measurement could not be performed correctly. <ul style="list-style-type: none"> Try executing correlation using ColorNavigator 6.
0034	<ul style="list-style-type: none"> Measurement failed. Execute SelfCalibration again.
0036	<ul style="list-style-type: none"> There may be a problem with the target value setting. Recheck the target value of the Color Gamut. It is possible that measurement could not be performed correctly. <ul style="list-style-type: none"> Ensure that the built-in calibration sensor is not exposed to strong light such as direct sunlight. Try executing correlation using ColorNavigator 6.
0037	<ul style="list-style-type: none"> It is possible that measurement could not be performed correctly. <ul style="list-style-type: none"> Try executing correlation using ColorNavigator 6.
0038 0039 0040 0041 0050	<ul style="list-style-type: none"> The built-in calibration sensor may have failed. Contact your local EIZO representative.
0060 0061	<ul style="list-style-type: none"> The built-in calibration sensor failed to open/close. Turn off the main power on the rear side of the monitor, wait for a few minutes before turning the power back on, and then execute SelfCalibration again.

Chapter 8 Reference

8-1. Attaching the Optional Arm

An optional arm (or an optional stand) can be attached by removing the stand section. Please refer to our web site for the corresponding optional arm (or optional stand). <http://www.eizoglobal.com>

Attention

- When attaching an arm or stand, follow the instructions of their User's Manual.
- When using another manufacturer's arm or stand, confirm the following in advance and select one conforming to the VESA standard.
 - Clearance between the screw holes: 100 mm × 100 mm
 - Thickness of plate: 2.6 mm
 - Strong enough to support weight of the monitor unit (except the stand) and attachments such as cables.
- When using another manufacturer's arm or stand, use the following screws to secure it.
 - Screws fixing the stand to the monitor.
- When using an arm or stand, attach it to meet the following tilt angles of the monitor.
 - Up 45°, down 45°
- Connect the cables after attaching an arm or stand.
- Do not move the removed stand up and down. Doing so may result in injury or device damage.
- The monitor and arm or stand are heavy. Dropping them may result in injury or equipment damage.
- When setting the monitor to the portrait style, turn the monitor screen 90° in clockwise direction.

Procedure

1. Lay the LCD monitor on a soft cloth spread over on a stable surface with the panel surface facing down.

2. Remove the stand.

Prepare a screwdriver. Loosen the screws (four) securing the unit and the stand with the screwdriver.

3. Attach the arm or stand to the monitor.

Secure the monitor to the arm or stand using the screws fixing the stand to the monitor.

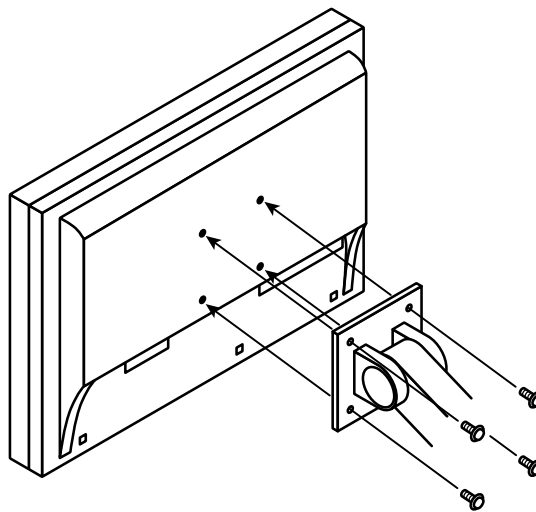

8-2. Making Use of USB (Universal Serial Bus)

This monitor has a USB hub. It works as a USB hub when connected to a USB-compatible PC, allowing the connection of peripheral USB devices.

● System Requirement

- A PC (including devices with a USB host function) and OS in conformance with USB Specification Revision 2.0
- USB cable

Attention

- This monitor may not work depending on PC, OS or peripheral devices. For USB compatibility of peripheral devices, contact their manufactures.
- Devices connected to the USB downstream port work when the monitor is in power saving mode or when the power button of the monitor is Off. Therefore, power consumption of the monitor varies with connected devices even in the power saving mode.
- When the main power of the monitor is Off, device connected to the USB downstream port does not operate.

● Procedure

1. Connect the signal cable between a PC and the monitor, and turn on the PC.
2. Using the USB cable, connect the computer's downstream port and the monitor's upstream port 1.
3. Connect the peripheral USB device to the USB downstream port of the monitor.

Note

- By default, USB upstream port 1 is enabled. To connect two PCs, see “5-4. Switching USB Port Automatically” (page 43).

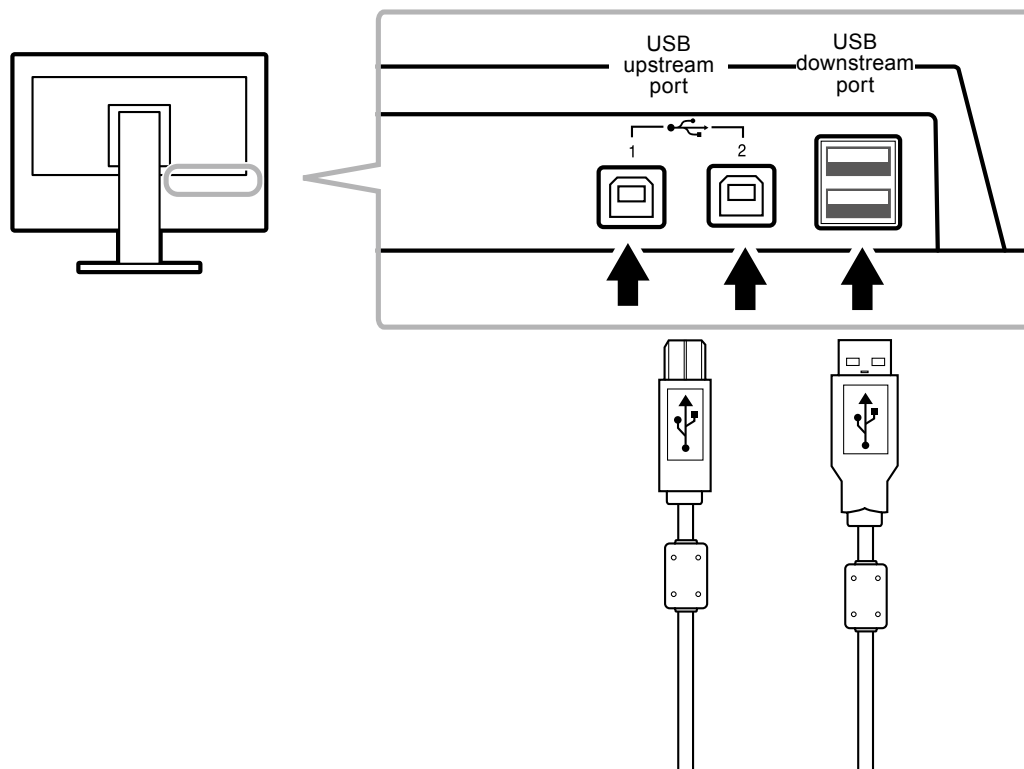

8-3. Showing Monitor Information

● Displaying signal information

This function displays the information about the current input signals displayed.

Procedure

1. Choose “Tools” from the Adjustment menu, and press ENTER.
2. Choose “Signal Info” from “Tools”, and press ENTER.

The “Signal Info” appears.

(Example)

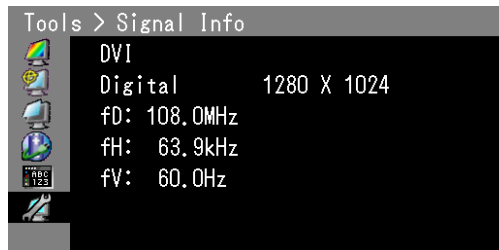

● Displaying Monitor Information

This function displays the information about the monitor.

Procedure

1. Choose “Tools” from the Adjustment menu, and press ENTER.
2. Choose “Monitor Info” from “Tools”, and press ENTER.

The “Monitor Info” appears.

This function displays the model name, serial number, firmware version, usage time, and ColorNavigator license status.

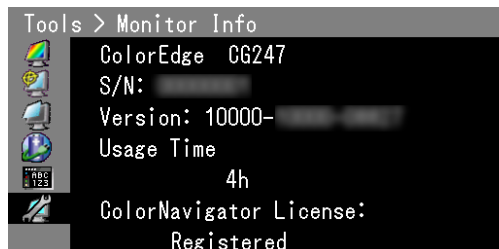

Attention

- Due to inspection at the factory, the usage time when the power to the monitor is first turned on may not be “0”.
-

8-4. Specifications

LCD Panel	Size		61 cm (24.0) format	
	Type		Color TFT(IPS)	
	Backlight		LED	
	Display area (H × V)		518.4 mm × 324.0 mm (20.4 inch × 12.8 inch)	
	Viewing angles		Horizontal: 178°, vertical: 178°	
	Recommended Brightness		120 cd/m ² or less (with "Temperature" of between "5000K" to "6500K")	
	Recommended resolution		1920 x 1200	
	Contrast ratio		1000 : 1 (When "DUE Priority" setting is "Brightness")	
	Dot pitch		0.27 mm × 0.27 mm	
	Response time	Black-white-black:	Approx. 12 ms	
		Gray-to-gray:	Approx. 7.7 ms (When the Overdrive setting is "On")	
Color gamut display (typical)	Adobe® RGB Coverage	99 %		
	NTSC ratio	110 %		
Video signal	Input Terminals		DVI-D x 1 (Single Link , applicable to HDCP) HDMI x 1 (Applicable to HDCP) DisplayPort x 1(Applicable to HDCP)	
	Dot clock (Max.)		164.5 MHz	
	Horizontal scan frequency	DVI / DisplayPort	26 kHz - 78 kHz	
		HDMI	15 kHz - 78 kHz	
	Vertical scan frequency	DVI / DisplayPort	23.75 Hz - 63 Hz (non-interlace, 720 x 400: 69 Hz - 71 Hz)	
		HDMI	23.75 Hz - 61 Hz (720 x 400: 69 Hz - 71 Hz)	
		Frame Synchronous mode	23.75 Hz - 30.5 Hz 47.5 Hz - 61 Hz	
	Max. display color	DisplayPort	Approx. 1073.74 million colors (for 10 bit input)	
		HDMI	Approx. 1073.74 million colors (for 10 bit, 12 bit input)	
		DVI	Approx. 16.77 million colors	
	Plug & Play	DVI / HDMI	VESA DDC2B / EDID structure 1.3	
DisplayPort		VESA DisplayPort / EDID structure 1.4		
Power supply			100-120 Vac ±10%, 50/60 Hz 0.9A 200-240 Vac ±10%, 50/60 Hz 0.5A	
	Power consumption	Screen display On	83 W or less	
		Power saving mode	0.7 W or less (when only the DisplayPort 1 connector is connected, "Input Selection" is set to "Manual", no USB device is connected, and DP Power Save is set to "On", the OS entered sleep mode or the monitor's power off setting activated)	
		Power Off	0.5 W or less (when no USB device is connected, DP Power Save is set to "On")	
		Main power Off	0 W	
	Power saving settings	DVI	DVI DMPM	
DisplayPort		DisplayPort Standard V1.1a		
Physical Specifications	Dimensions (width) × (height) × (depth)	Main unit		575.0 mm (22.6 inch) × 417.0 mm - 545.0 mm (16.4 inch - 21.5 inch) × 245.5 mm (9.7 inch)
		Main unit (without stand)		575.0 mm (22.6 inch) × 398.0 mm (15.7 inch) × 75.0 mm (2.95 inch)
		With monitor hood	Landscape	582.5 mm (22.9 inch) × 553.0 mm (21.8 inch) × 369.0 mm (14.5 inch)
			Portrait	406.0mm (16.0 inch) × 649.5 mm (25.6 inch) × 369.0 mm (14.5 inch)
	Net. weight	Main unit		Approx. 9.1 kg (20.1 lbs.)
		Main unit (without stand)		Approx. 6.5 kg (14.3 lbs.)
		With monitor hood		Approx. 13.0kg (28.7 lbs.)
	Movable range	Tilt		Up 30°, down 0°
		Swivel		344°
		Height adjustment		128.0 mm (6.0 inch, When Tilt angle is 0°)
Rotation:		90° (clockwise)		

Environmental conditions	Temperature	Operating	0 °C to 35 °C (32 °F to 95 °F)
		Transportation/Storage	-20 °C to 60 °C (-4 °F to 140 °F)
	Humidity (R.H, no condensation)	Operating	20% to 80%
		Transportation/Storage	10% to 90%
	Air pressure	Operating	540 hPa to 1060 hPa
		Transportation/Storage	200 hPa to 1060 hPa
USB	Input Terminals		Upstream port × 2, Downstream port × 2
	Standard		USB Specification Revision 2.0
	Supply current		Max. 500mA / 1 port

Main Default Settings

Color Mode		Custom
Screen Size	PC signal	Full
	video: HD signal (HDMI)	Enlarged
	video: SD signal (HDMI)	Auto
Overdrive		Off
Color Space		Auto
Input Range	DVI	Full
	DisplayPort / HDMI	Auto
Noise Reduction		Off
Power Save		On
Language		English
Menu Position		Center
Input Selection		Manual
USB Selection		USB-1
Signal Format	HDMI	Video

Outside Dimensions

Unit: mm

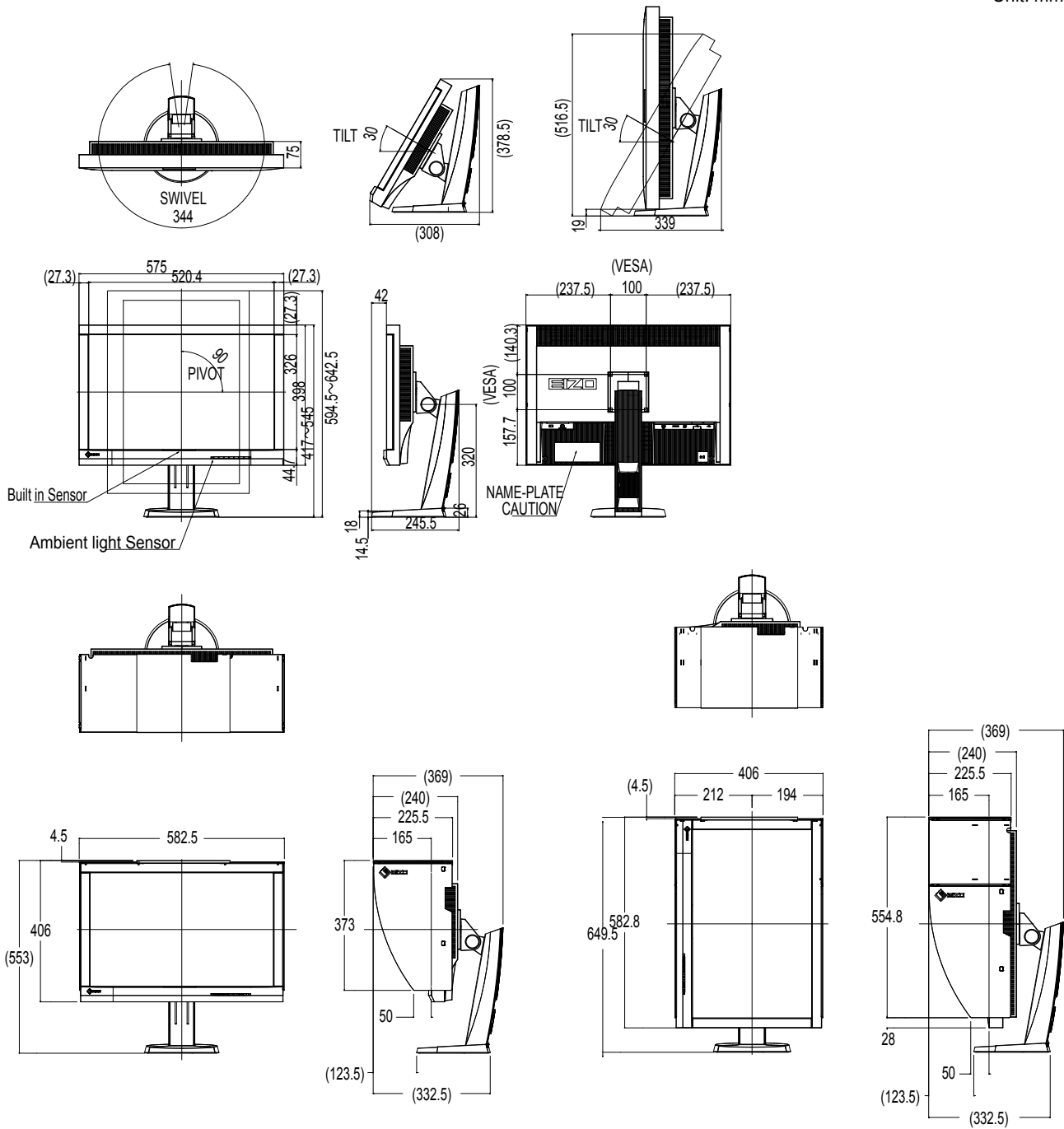

Accessories

For the latest information about the accessories and information about the latest compatible graphics board, refer to our web site.

<http://www.eizoglobal.com>

Chapter 9 Glossary

Adobe®RGB

This is a definition of the practical RGB color space proposed by Adobe Systems in 1998. The color reproduction range (color gamut) is broader than sRGB, and is highly adaptable to such fields as printing etc.

Color Space

YUV and RGB, etc. are available. YUV expresses the color by using the luminance (Y), the color difference of Blue (U), and the color difference of Red (V). RGB does this by using the gradation of the 3 colors, Red (R), Green (G), and Blue (B).

DCI (Digital Cinema Initiatives)

The company was founded by an association of U.S. film studios, and this company decides the specifications for digital cinema.

DisplayPort

This is the interface standard for image signals standardized in accordance with VESA. It was developed with the aim of replacing the conventional DVI and analog interfaces, and it can transmit high resolution signals and sound signals, which DVI does not support. It also supports 10-bit color, copyright protection technology, long cables, etc. The standard size and mini size connectors have been standardized.

DVI (Digital Visual Interface)

DVI is a digital interface standard. DVI allows direct transmission of the PC's digital data without loss. This adopts the TMDS transmission system and DVI connectors. There are two types of DVI connectors. One is a DVI-D connector for digital signal input only. The other is a DVI-I connector for both digital and analog signal inputs.

DVI DMPM (DVI Digital Monitor Power Management)

DVI DMPM is a digital interface power saving function. The "Monitor ON (operating mode)" and "Active Off (power saving mode)" are indispensable for DVI DMPM as the monitor's power mode.

EBU (European Broadcasting Union)

The organization also includes broadcasting offices from Europe and North Africa, and its role is to decide various technical standards etc.

Gain

The brightness of each color component red, green, and blue is called Gain. An LCD monitor displays the color by the light passing through the panel color filter. Red, green and blue are the three primary colors. All the colors on the screen are displayed by combining these three colors. The color tone can be changed by adjusting the light intensity (volume) passing through each color's filter.

Gamma

Generally, the monitor brightness varies nonlinearly with the input signal level, which is called “Gamma Characteristic”. A small gamma value produces a low-contrast image, while a large gamma value produces a highcontrast image.

HDCP (High-bandwidth Digital Content Protection)

Digital signal coding system developed to copy-protect the digital contents, such as video, music, etc. This helps to transmit the digital contents safely by coding the digital contents sent via the DVI or HDMI connector on the output side and decoding them on the input side. Any digital contents cannot be reproduced if both of the equipments on the output and input sides are not applicable to HDCP system.

HDMI (High-Definition Multimedia Interface)

HDMI is a digital interface standard, developed for consumer electrical appliance or AV device. This standard is issued on the basis of the DVI standard which is one of an interface specification for the connection between a PC and a monitor. The projected image, sound and control signal without compressed enable to be transmitted with one cable.

L*

L* is a lightness value based on the CIELUV and CIELAB color spaces. CIELUV and CIELAB are color spaces that describe the relationship between color and human vision, in which L* corresponds to perceived brightness.

Overdrive

This technology enhances response speed by increasing the potential difference at the time of motion of liquid-crystal pixels, and it is used for liquid-crystal TV sets and others in general. It provides clear-cut three-dimensional display with little afterimage, by improving response speed of the intermediate graduation range that frequently appears in moving images.

Rec709

Digital broadcasting (HDTV) standards defined by the ITU-R (International Telecommunication Union Radio Communication Sector).

Rec1886

Standards for the input/output characteristics of flat panel displays used in studio production for digital broadcasting (HDTV) specified by the ITU-R based on CRT characteristics.

Resolution

The LCD panel consists of numerous pixels of specified size, which are illuminated to form images. This monitor consists of horizontal 1920 pixels and 1200 vertical pixels. At a resolution of 1920×1200 , all pixels are illuminated as a full screen (1:1).

SMPTE-C

One of the standards provided by the SMPTE (Society of Motion Picture and Television Engineers).

sRGB (Standard RGB)

International standard for color reproduction and color space among peripheral devices (such as monitors, printers, digital cameras, scanners). As a form of simple color matching for the Internet, colors can be displayed using tones close to those of the transmission and reception devices.

Temperature

Color temperature is a method to measure the white color tone, generally indicated in degrees Kelvin. The screen becomes reddish at a low temperature, and bluish at a high temperature, like the flame temperature.

5000 K: Slightly reddish white

6500 K: White referred to as daylight-balanced color

9300 K: Slightly bluish white

Appendix

Trademark

The terms HDMI and HDMI High-Definition Multimedia Interface, and the HDMI Logo are trademarks or registered trademarks of HDMI Licensing, LLC in the United States and other countries.

The DisplayPort Compliance Logo and VESA are registered trademarks of the Video Electronics Standards Association.

Acrobat, Adobe, Adobe AIR, and Photoshop are registered trademarks of Adobe Systems Incorporated in the United States and other countries.

AMD Athlon and AMD Opteron are trademarks of Advanced Micro Devices, Inc.

Apple, ColorSync, eMac, iBook, iMac, iPad, Mac, MacBook, Macintosh, Mac OS, PowerBook, and QuickTime are registered trademarks of Apple Inc.

ColorMunki, Eye-One, and X-Rite are registered trademarks or trademarks of X-Rite Incorporated in the United States and/or other countries.

ColorVision and ColorVision Spyder2 are registered trademarks of DataColor Holding AG in the United States. Spyder3 and Spyder4 are trademarks of DataColor Holding AG.

ENERGY STAR is a registered trademark of the United States Environmental Protection Agency in the United States and other countries.

GRACoL and IDEAlliance are registered trademarks of International Digital Enterprise Alliance.

NEC is a registered trademark of NEC Corporation.

PC-9801 and PC-9821 are trademarks of NEC Corporation.

NextWindow is a registered trademark of NextWindow Ltd.

Intel, Intel Core, Pentium and Thunderbolt are trademarks of Intel Corporation in the United States and other countries.

PowerPC is a registered trademark of International Business Machines Corporation.

PlayStation is a registered trademark of Sony Computer Entertainment Inc.

PSP and PS3 are trademarks of Sony Computer Entertainment Inc.

RealPlayer is a registered trademark of RealNetworks, Inc.

TouchWare is a trademark of 3M Touch Systems, Inc.

Windows, Windows Media, Windows Vista, SQL Server, and Xbox 360 and Internet Explorer are registered trademarks of Microsoft Corporation in the United States and other countries.

YouTube is a registered trademark of Google Inc.

Firefox is a registered trademark of the Mozilla Foundation.

Kensington and MicroSaver are trademarks of ACCO Brands Corporation.

EIZO, the EIZO Logo, ColorEdge, DuraVision, FlexScan, FORIS, RadiCS, RadiForce, RadiNET, Raptor, and ScreenManager are registered trademarks of EIZO Corporation in Japan and other countries.

ColorNavigator, EcoView NET, EIZO EasyPIX, EIZO ScreenSlicer, i•Sound, Screen Administrator, and UniColor Pro are trademarks of EIZO Corporation.

All other company and product names are trademarks or registered trademarks of their respective owners.

License / Copyright

A round gothic bold bit map font designed by Ricoh is used for the characters displayed on this product.

FCC Declaration of Conformity

For U.S.A. , Canada, etc. (rated 100-120 Vac) Only

FCC Declaration of Conformity

We, the Responsible Party

EIZO Inc.

5710 Warland Drive, Cypress, CA 90630

Phone: (562) 431-5011

declare that the product

Trade name: EIZO

Model: ColorEdge CG247

is in conformity with Part 15 of the FCC Rules. Operation of this product is subject to the following two conditions: (1) this device may not cause harmful interference, and (2) this device must accept any interference received, including interference that may cause undesired operation.

This equipment has been tested and found to comply with the limits for a Class B digital device, pursuant to Part 15 of the FCC Rules. These limits are designed to provide reasonable protection against harmful interference in a residential installation. This equipment generates, uses, and can radiate radio frequency energy and, if not installed and used in accordance with the instructions, may cause harmful interference to radio communications. However, there is no guarantee that interference will not occur in a particular installation. If this equipment does cause harmful interference to radio or television reception, which can be determined by turning the equipment off and on, the user is encouraged to try to correct the interference by one or more of the following measures.

- * Reorient or relocate the receiving antenna.
- * Increase the separation between the equipment and receiver.
- * Connect the equipment into an outlet on a circuit different from that to which the receiver is connected.
- * Consult the dealer or an experienced radio/TV technician for help.

Changes or modifications not expressly approved by the party responsible for compliance could void the user's authority to operate the equipment.

Note

Use the attached specified cable below or EIZO signal cable with this monitor so as to keep interference within the limits of a Class B digital device.

- AC Cord
- Shielded Signal Cable (Enclosed)

Canadian Notice

This Class B digital apparatus complies with Canadian ICES-003.

Cet appareil numérique de la classe B est conforme à la norme NMB-003 du Canada.

Hinweise zur Auswahl des richtigen Schwenkarms für Ihren Monitor

Dieser Monitor ist für Bildschirmarbeitsplätze vorgesehen. Wenn nicht der zum Standardzubehör gehörige Schwenkarm verwendet wird, muss statt dessen ein geeigneter anderer Schwenkarm installiert werden. Bei der Auswahl des Schwenkarms sind die nachstehenden Hinweise zu berücksichtigen:

Der Standfuß muß den nachfolgenden Anforderungen entsprechen:

- a) Der Standfuß muß eine ausreichende mechanische Stabilität zur Aufnahme des Gewichtes vom Bildschirmgerät und des spezifizierten Zubehörs besitzen. Das Gewicht des Bildschirmgerätes und des Zubehörs sind in der zugehörigen Bedienungsanleitung angegeben.
- b) Die Befestigung des Standfusses muß derart erfolgen, daß die oberste Zeile der Bildschirmanzeige nicht höher als die Augenhöhe eines Benutzers in sitzender Position ist.
- c) Im Fall eines stehenden Benutzers muß die Befestigung des Bildschirmgerätes derart erfolgen, daß die Höhe der Bildschirmmitte über dem Boden zwischen 135 – 150 cm beträgt.
- d) Der Standfuß muß die Möglichkeit zur Neigung des Bildschirmgerätes besitzen (max. vorwärts: 5°, min. nach hinten $\geq 5^\circ$).
- e) Der Standfuß muß die Möglichkeit zur Drehung des Bildschirmgerätes besitzen (max. $\pm 180^\circ$). Der maximale Kraftaufwand dafür muß weniger als 100 N betragen.
- f) Der Standfuß muß in der Stellung verharren, in die er manuell bewegt wurde.
- g) Der Glanzgrad des Standfusses muß weniger als 20 Glanzeinheiten betragen (seidenmatt).
- h) Der Standfuß mit Bildschirmgerät muß bei einer Neigung von bis zu 10° aus der normalen aufrechten Position kippsicher sein.

Hinweis zur Ergonomie :

Dieser Monitor erfüllt die Anforderungen an die Ergonomie nach EK1-ITB2000 mit dem Videosignal, 1920 × 1200, Digital Eingang und mindestens 60,0 Hz Bildwiederholfrequenz, non interlaced. Weiterhin wird aus ergonomischen Gründen empfohlen, die Grundfarbe Blau nicht auf dunklem Untergrund zu verwenden (schlechte Erkennbarkeit, Augenbelastung bei zu geringem Zeichenkontrast.)

„Maschinenlärminformations-Verordnung 3. GPSGV:

Der höchste Schalldruckpegel beträgt 70 dB(A) oder weniger gemäss EN ISO 7779“

LIMITED WARRANTY

LIMITED WARRANTY

EIZO Corporation (hereinafter referred to as “**EIZO**”) and distributors authorized by EIZO (hereinafter referred to as the “**Distributors**”) warrant, subject to and in accordance with the terms of this limited warranty (hereinafter referred to as the “**Warranty**”), to the original purchaser (hereinafter referred to as the “**Original Purchaser**”) who purchased the product specified in this document (hereinafter referred to as the “**Product**”) from EIZO or Distributors, that EIZO and Distributors shall, at their sole discretion, either repair or replace the Product at no charge if the Original Purchaser becomes aware within the Warranty Period (defined below) that the Product malfunctions or is damaged in the course of normal use of the Product in accordance with the description in the instruction manual attached to the Product (hereinafter referred to as the “**User’s Manual**”).

The period of this Warranty is limited to (i) five (5) years from the date of purchase of the Product; or, limited to the expiration of (ii) 30,000 hours of its use of the Product (hereinafter referred to as the “**Warranty Period**”). However, the brightness of the Product shall be warranted only if the Product has been used within the recommended brightness described in the User’s Manual. The Warranty Period for the brightness is also limited to five (5) years from the date of purchase of the Product subject to the usage time being less than or equal to 10,000 hours. EIZO and Distributors shall bear no liability or obligation with regard to the Product in relation to the Original Purchaser or any third parties other than as provided under this Warranty.

EIZO and Distributors will cease to hold or store any parts (excluding design parts) of the Product upon expiration of seven (7) years after the production of such parts is discontinued. In repairing the monitor, EIZO and Distributors will use renewal parts which comply with our QC standards. If the unit cannot be repaired due to its condition or the stockout of a relevant part, EIZO and Distributors may offer the replacement by a product with equivalent performance instead of repairing it.

The Warranty is valid only in the countries or territories where the Distributors are located. The Warranty does not restrict any legal rights of the Original Purchaser.

Notwithstanding any other provision of this Warranty, EIZO and Distributors shall have no obligation under this Warranty whatsoever in any of the cases as set forth below:

- (a) Any defect of the Product caused by freight damage, modification, alteration, abuse, misuse, accident, incorrect installation, disaster, faulty maintenance and/or improper repair by third party other than EIZO and Distributors;
- (b) Any incompatibility of the Product due to possible technical innovations and/or regulations;
- (c) Any deterioration of the sensor;
- (d) Any deterioration of display performance caused by the deterioration of expendable parts such as the LCD panel and/or backlight, etc. (e.g. changes in brightness uniformity, changes in color, changes in color uniformity, defects in pixels including burnt pixels, etc.);
- (e) Any deterioration of the Product caused by the use at higher brightness than the recommended brightness described in the User’s Manual;
- (f) Any defect of the Product caused by external equipment;
- (g) Any defect of the Product on which the original serial number has been altered or removed;
- (h) Any normal deterioration of the product, particularly that of consumables, accessories, and/or attachments (e.g. buttons, rotating parts, cables, User’s Manual, etc.); and
- (i) Any deformation, discoloration, and/or warp of the exterior of the product including that of the surface of the LCD panel.

To obtain service under the Warranty, the Original Purchaser must deliver the Product, freight prepaid, in its original package or other adequate package affording an equal degree of protection, assuming the risk of damage and/or loss in transit, to the local Distributor. The Original Purchaser must present proof of purchase of the Product and the date of such purchase when requesting services under the Warranty.

The Warranty Period for any replaced and/or repaired product under this Warranty shall expire at the end of the original Warranty Period.

EIZO OR DISTRIBUTORS ARE NOT RESPONSIBLE FOR ANY DAMAGE TO, OR LOSS OF, DATA OR OTHER INFORMATION STORED IN ANY MEDIA OR ANY PART OF ANY PRODUCT RETURNED TO EIZO OR DISTRIBUTORS FOR REPAIR.

EIZO AND DISTRIBUTORS MAKE NO FURTHER WARRANTIES, EXPRESSED OR IMPLIED, WITH RESPECT TO THE PRODUCT AND ITS QUALITY, PERFORMANCE, MERCHANTABILITY OR FITNESS FOR ANY PARTICULAR USE. IN NO EVENT SHALL EIZO OR DISTRIBUTORS BE LIABLE FOR ANY INCIDENTAL, INDIRECT, SPECIAL, CONSEQUENTIAL OR OTHER DAMAGE WHATSOEVER (INCLUDING, WITHOUT LIMITATION, DAMAGES FOR LOSS OF PROFIT, BUSINESS INTERRUPTION, LOSS OF BUSINESS INFORMATION, OR ANY OTHER PECUNIARY LOSS) ARISING OUT OF THE USE OR INABILITY TO USE THE PRODUCT OR IN ANY CONNECTION WITH THE PRODUCT, WHETHER BASED ON CONTRACT, TORT, NEGLIGENCE, STRICT LIABILITY OR OTHERWISE, EVEN IF EIZO OR DISTRIBUTORS HAVE BEEN ADVISED OF THE POSSIBILITY OF SUCH DAMAGES. THIS EXCLUSION ALSO INCLUDES ANY LIABILITY WHICH MAY ARISE OUT OF THIRD PARTY CLAIMS AGAINST THE ORIGINAL PURCHASER. THE ESSENCE OF THIS PROVISION IS TO LIMIT THE POTENTIAL LIABILITY OF EIZO AND DISTRIBUTORS ARISING OUT OF THIS LIMITED WARRANTY AND/OR SALES.

BEGRENZTE GARANTIE

EIZO Corporation (im Weiteren als „**EIZO**“ bezeichnet) und die Vertragsimporteure von EIZO (im Weiteren als „**Vertrieb(e)**“ bezeichnet) garantieren dem ursprünglichen Käufer (im Weiteren als „**Erstkäufer**“ bezeichnet), der das in diesem Dokument vorgegebene Produkt (im Weiteren als „**Produkt**“ bezeichnet) von EIZO oder einem Vertrieb erworben hat, gemäß den Bedingungen dieser beschränkten Garantie (im Weiteren als „**Garantie**“ bezeichnet), dass EIZO und der Vertrieb nach eigenem Ermessen das Produkt entweder kostenlos reparieren oder austauschen, falls der Erstkäufer innerhalb der Garantiefrist (weiter unten festgelegt) eine Fehlfunktion bzw. Beschädigung des Produkts feststellt, die während des normalen Gebrauchs des Produkts gemäß den Anweisungen des zum Lieferumfang des Produkts gehörenden Benutzerhandbuchs (im Weiteren als „**Benutzerhandbuch**“ bezeichnet) aufgetreten ist.

Die Dauer der Garantieleistung beträgt (i) fünf (5) Jahre ab dem Erstverkaufsdatum des Produkts oder (ii) 30.000 Betriebsstunden des Produkts (im Weiteren als „**Garantiefrist**“ bezeichnet). Die Helligkeit des Produkts wird allerdings nur garantiert, wenn das Produkt innerhalb der empfohlenen Helligkeit, wie im Benutzerhandbuch beschrieben, verwendet wird. Die Dauer der Garantiefrist für die Helligkeit ist außerdem auf fünf (5) Jahre ab dem Kaufdatum des Produkts beschränkt, vorausgesetzt, dass die Benutzungszeit des Produkts maximal 10.000 Betriebsstunden. EIZO und die Vertriebe übernehmen über den Rahmen dieser Garantie hinaus hinsichtlich des Produkts keinerlei Haftung oder Verpflichtung dem Erstkäufer oder Dritten gegenüber.

Nach Ablauf von sieben (7) Jahren nach Ende der Produktion solcher Teile werden EIZO und Vertriebshändler keine Teile (mit Ausnahme von Konstruktionsteilen) mehr vorhalten und lagern. EIZO und seine Vertriebspartner verpflichten sich, bei einer etwaigen Reparatur des Monitors ausschließlich Produkte gemäß den EIZO-Qualitätssicherungsstandards zu verwenden. Wenn das Gerät aufgrund seines Zustands oder eines Fehlbestands bei einem entsprechenden Teil nicht repariert werden kann, können EIZO und Vertriebshändler statt der Reparatur des Geräts den Austausch gegen ein Produkt mit gleichwertiger Leistung anbieten.

Diese Garantie gilt nur in Ländern oder Gebieten, in denen sich Vertriebe befinden. Die gesetzlichen Gewährleistungsrechte des Erstkäufers gegenüber dem Verkäufer werden durch diese Garantie nicht berührt.

EIZO und die Vertriebe besitzen im Rahmen dieser Garantie keinerlei Verpflichtung in den folgenden Fällen:

- (a) Produktdefekte, die auf Frachtschäden, Modifikation, Nachgestaltung, Missbrauch, Fehlbedienung, Unfälle, unsachgemäße Installation, Naturkatastrophen, fehlerhafte Wartung und/oder unsachgemäße Reparatur durch eine andere Partei als EIZO und die Vertriebe zurückzuführen sind.
- (b) Eine Inkompatibilität des Produkts aufgrund von technischen Neuerungen und/oder neuen Bestimmungen, die nach dem Kauf in Kraft treten.
- (c) Jegliche Verschlechterung des Sensors.
- (d) Jegliche Verschlechterung der Bildschirmleistung, die durch Verschleißteile wie das LCD-Panel und/oder die Hintergrundbeleuchtung usw. hervorgerufen werden (z.B. Veränderungen von Helligkeitsverteilung, Veränderungen von Farbe oder Farbverteilung, Pixeldefekte einschließlich von durchgebrannten Pixeln usw.).
- (e) Jegliche Abnutzung des Produkts, die auf einen Gebrauch mit einer höheren Helligkeit als die im Benutzerhandbuch genannte empfohlene Helligkeit zurückzuführen ist.
- (f) Produktdefekte, die durch externe Geräte verursacht werden.
- (g) Jeglicher Defekt eines Produkts, dessen ursprüngliche Seriennummer geändert oder entfernt wurde.
- (h) Normale Abnutzung des Produkts, insbesondere von Verbrauchsteilen, Zubehörteilen und/oder Beilagen (z.B. Tasten, drehbare Teile, Kabel, Benutzerhandbuch usw.); sowie
- (i) Verformungen, Verfärbungen und/oder Verziehungen am Produktäußeren, einschließlich der Oberfläche des LCD-Panels.

Bei Inanspruchnahme der Garantieleistung ist der Erstkäufer verpflichtet, das Produkt auf eigene Kosten und in der Originalverpackung bzw. einer anderen geeigneten Verpackung, die einen gleichwertigen Schutz gegen Transportschäden bietet, an den örtlichen Vertrieb zu übersenden, wobei der Erstkäufer das Transportrisiko gegenüber Schäden und/oder Verlust trägt. Zum Zeitpunkt der Inanspruchnahme der Garantieleistung muss der Erstkäufer einen Verkaufsbeleg vorweisen, auf dem das Kaufdatum angegeben ist.

Die Garantiefrist für ein im Rahmen dieser Garantie ausgetauschtes und/oder repariertes Produkt erlischt nach Ablauf der ursprünglichen Garantiefrist.

EIZO ODER DIE EIZO-VERTRAGSIMPORTEURE HAFTEN NICHT FÜR ZERSTÖRTE DATENBESTÄNDE ODER DIE KOSTEN DER WIEDERBESCHAFFUNG DIESER DATENBESTÄNDE AUF JEDLICHEN DATENTRÄGERN ODER TEILEN DES PRODUKTS, DIE IM RAHMEN DER GARANTIE BEI EIZO ODER DEN EIZO-VERTRAGSIMPORTEUREN ZUR REPARATUR EINGEREICHT WURDEN.

EIZO UND DIE EIZO-VERTRAGSIMPORTEURE GEBEN WEDER EXPLIZITE NOCH IMPLIZITE GARANTIEEN IN BEZUG AUF DIESES PRODUKT UND SEINE QUALITÄT, LEISTUNG, VERKÄUFLICHKEIT ODER EIGNUNG FÜR EINEN BESTIMMTEN ZWECK. AUF KEINEN FALL SIND EIZO ODER DIE EIZO-VERTRAGSIMPORTEURE VERANTWORTLICH FÜR JEDLICHE ZUFÄLLIGE, INDIREKTE, SPEZIELLE, FOLGE- ODER ANDERE SCHÄDEN JEDLICHER ART (EINSCHLIESSLICH OHNE JEDE BEGRENZUNG SCHÄDEN BEZÜGLICH PROFITVERLUST, GESCHÄFTSUNTERBRECHUNG, VERLUST VON GESCHÄFTSINFORMATION ODER JEDLICHE ANDEREN FINANZIELLEN EINBUSSEN), DIE DURCH DIE VERWENDUNG DES PRODUKTES ODER DIE UNFÄHIGKEIT ZUR VERWENDUNG DES PRODUKTES ODER IN JEDLICHER BEZIEHUNG MIT DEM PRODUKT, SEI ES BASIEREND AUF VERTRAG, SCHADENSERSATZ, NACHLAESSIGKEIT, STRIKTE HAFTPFLICHT ODER ANDEREN FORDERUNGEN ENTSTEHEN, AUCH WENN EIZO UND DIE EIZO-VERTRAGSIMPORTEURE IM VORAUS ÜBER DIE MÖGLICHKEIT SOLCHER SCHÄDEN INFORMIERT WURDEN. DIESER AUSSCHLUSS ENTHÄLT AUCH JEDE HAFTPFLICHT, DIE AUS FORDERUNGEN DRITTER GEGEN DEN ERSTKÄUFER ENTSTEHEN KANN. ZWECK DIESER KLAUSEL IST ES, DIE HAFTUNG VON EIZO UND DEN VERTRIEBEN GEGENÜBER FORDERUNGEN ZU BEGRENZEN, DIE AUS DIESER BESCHRÄNKTEN GARANTIE UND/ODER DEM VERKAUF ENTSTEHEN KÖNNEN.

GARANTIE LIMITÉE

EIZO Corporation (ci-après dénommé « **EIZO** ») et les distributeurs autorisés par EIZO (ci-après dénommés « **Distributeurs** »), sous réserve et conformément aux termes de cette garantie limitée (ci-après dénommée « **Garantie** »), garantissent à l'acheteur initial (ci-après dénommé « **Acheteur initial** ») du produit spécifié dans la présente (ci-après dénommé « **Produit** ») acheté auprès d'EIZO ou de Distributeurs agréés EIZO, que EIZO et ses Distributeurs auront pour option de réparer ou remplacer gratuitement le Produit si l'Acheteur initial constate, pendant la Période de garantie (définie ci-dessous), qu'il y a un dysfonctionnement ou que le Produit a subi un dommage dans le cadre d'une utilisation normale du Produit conformément à la description du mode d'emploi qui accompagne le Produit (ci-après dénommé « **Manuel d'utilisation** »).

La période de cette Garantie est limitée à (i) cinq (5) ans à partir de la date d'achat du Produit ; ou, limitée jusqu'à l'expiration de (ii) 30 000 heures d'utilisation du Produit (ci-après dénommée « **Période de Garantie** »). Cependant, la luminosité du Produit ne sera garantie que si le Produit a été utilisé conformément à la luminosité recommandée dans le Manuel d'Utilisation. La Période de Garantie en matière de luminosité est également limitée à cinq (5) ans à compter de la date d'achat du Produit, sous réserve que la durée d'utilisation soit inférieure ou égale à 10 000 heures. EIZO et ses Distributeurs déclinent toute responsabilité ou obligation concernant ce Produit face à l'Acheteur initial ou à toute autre personne à l'exception de celles stipulées dans la présente Garantie.

EIZO et ses Distributeurs cesseront de conserver ou de stocker des pièces (à l'exception des pièces de conception) du Produit à l'expiration d'une période de sept (7) ans après l'arrêt de la production de ces pièces. Pour réparer le moniteur, EIZO et ses distributeurs utiliseront des pièces de rechange conformes à nos normes de contrôle qualité. Si l'unité ne peut pas être réparée en raison de son état ou de la rupture de stock d'une pièce adéquate, EIZO et ses Distributeurs peuvent proposer le remplacement par un produit aux performances équivalentes au lieu de le réparer.

La Garantie est valable uniquement dans les pays ou les territoires où se trouvent les Distributeurs. La Garantie ne limite aucun des droits reconnus par la loi à l'Acheteur initial.

Nonobstant toute autre clause de cette Garantie, EIZO et ses Distributeurs n'auront d'obligation dans le cadre de cette Garantie pour aucun des cas énumérés ci-dessous :

- (a) Tout défaut du Produit résultant de dommages occasionnés lors du transport, d'une modification, d'une altération, d'un abus, d'une mauvaise utilisation, d'un accident, d'une installation incorrecte, d'un désastre, d'un entretien et/ou d'une réparation incorrects effectués par une personne autre que EIZO ou ses Distributeurs ;
- (b) Toute incompatibilité du Produit résultant d'améliorations techniques et/ou réglementations possibles ;
- (c) Toute détérioration du capteur ;
- (d) Toute détérioration des performances d'affichage causée par la détérioration des éléments consommables tels que le panneau LCD et/ou le rétroéclairage, etc. (par exemple des changements de l'uniformité de la luminosité, des modifications de couleur, des changements de l'uniformité des couleurs, des défauts de pixels y compris des pixels brûlés, etc.);
- (e) Toute détérioration du Produit causée par l'utilisation d'une luminosité plus élevée que la luminosité recommandée, telle que décrite dans le Manuel d'utilisation ;
- (f) Tout défaut du Produit causé par un appareil externe ;
- (g) Tout défaut d'un Produit sur lequel le numéro de série original a été altéré ou supprimé ;
- (h) Toute détérioration normale du Produit, particulièrement celle des consommables, des accessoires et/ou des pièces reliées au Produit (touches, éléments pivotants, câbles, Manuel d'utilisation etc.), et
- (i) Toute déformation, décoloration, et/ou gondolage de l'extérieur du Produit, y compris celle de la surface du panneau LCD.

Pour bénéficier d'un service dans le cadre de cette Garantie, l'Acheteur initial doit renvoyer le Produit port payé, dans son emballage d'origine ou tout autre emballage approprié offrant un degré de protection équivalent, au Distributeur local, et assumera la responsabilité des dommages et/ou perte possibles lors du transport. L'Acheteur initial doit présenter une preuve d'achat du Produit comprenant sa date d'achat pour bénéficier de ce service dans le cadre de la Garantie.

La Période de garantie pour tout Produit remplacé et/ou réparé dans le cadre de cette Garantie expirera à la fin de la Période de garantie initiale.

EIZO OU SES DISTRIBUTEURS NE SAURAIENT ÊTRE TENUS RESPONSABLES DES DOMMAGES OU PERTES DE DONNÉES OU D'AUTRES INFORMATIONS STOCKÉES DANS UN MÉDIA QUELCONQUE OU UNE AUTRE PARTIE DU PRODUIT RENVOYÉ À EIZO OU AUX DISTRIBUTEURS POUR RÉPARATION.

AUCUNE AUTRE GARANTIE, EXPLICITE OU TACITE, N'EST OFFERTE PAR EIZO ET SES DISTRIBUTEURS CONCERNANT LE PRODUIT ET SES QUALITÉS, PERFORMANCES, QUALITÉ MARCHANDE OU ADAPTATION À UN USAGE PARTICULIER. EN AUCUN CAS, EIZO OU SES DISTRIBUTEURS NE SERONT RESPONSABLES DES DOMMAGES FORTUITS, INDIRECTS, SPÉCIAUX, INDIITS, OU DE TOUT AUTRE DOMMAGE QUEL QU'IL SOIT (Y COMPRIS, SANS LIMITATION, LES DOMMAGES RÉSULTANT D'UNE PERTE DE PROFIT, D'UNE INTERRUPTION D'ACTIVITÉS, D'UNE PERTE DE DONNÉES COMMERCIALES, OU DE TOUT AUTRE MANQUE À GAGNER) RÉSULTANT DE L'UTILISATION OU DE L'INCAPACITÉ D'UTILISER LE PRODUIT OU AYANT UN RAPPORT QUELCONQUE AVEC LE PRODUIT, QUE CE SOIT SUR LA BASE D'UN CONTRAT, D'UN TORT, D'UNE NÉGLIGENCE, D'UNE RESPONSABILITÉ STRICTE OU AUTRE, MÊME SI EIZO OU SES DISTRIBUTEURS ONT ÉTÉ AVERTIS DE LA POSSIBILITÉ DE TELS DOMMAGES. CETTE LIMITATION INCLUT AUSSI TOUTE RESPONSABILITÉ QUI POURRAIT ÊTRE SOULEVÉE LORS DES RÉCLAMATIONS D'UN TIERS CONTRE L'ACHETEUR INITIAL. L'ESSENCE DE CETTE CLAUSE EST DE LIMITER LA RESPONSABILITÉ POTENTIELLE DE EIZO ET DE SES DISTRIBUTEURS RÉSULTANT DE CETTE GARANTIE LIMITÉE ET/OU DES VENTES.

GARANTÍA LIMITADA

EIZO Corporation (en lo sucesivo “EIZO”) y sus distribuidores autorizados (en lo sucesivo los “Distribuidores”), con arreglo y de conformidad con los términos de esta garantía limitada (en lo sucesivo la “Garantía”), garantizan al comprador original (en lo sucesivo el “Comprador original”) que compró el producto especificado en este documento (en lo sucesivo el “Producto”) a EIZO o a sus Distribuidores, que EIZO y sus Distribuidores, a su propio criterio, repararán o sustituirán el Producto de forma gratuita si el Comprador original detecta dentro del periodo de la Garantía (indicado posteriormente) que el Producto no funciona correctamente o que se ha averiado durante el uso normal del mismo de acuerdo con las indicaciones del manual de instrucciones suministrado con el Producto (en lo sucesivo el “Manual del usuario”).

El período de validez de esta Garantía está limitado a (i) cinco (5) años a partir de la fecha de compra del Producto o (ii) a 30.000 horas de uso del Producto (en adelante designado como el “Período de Garantía”). De cualquier forma el brillo del Producto sólo estará cubierto por la garantía si el Producto se ha utilizado con el brillo recomendado que se describe en el Manual del usuario. El Período de garantía para el brillo está también limitado a cinco (5) años a partir de la fecha de compra del Producto, siempre que el tiempo de uso sea inferior o igual a 10.000 horas. EIZO y sus Distribuidores no tendrán ninguna responsabilidad ni obligación con respecto al Producto para con el Comprador original ni para con terceros que no sean las estipuladas en la presente Garantía.

EIZO y sus distribuidores dejarán de tener o almacenar cualquier pieza del producto (excepto piezas del diseño) una vez expirado el periodo de siete (7) años después de que hayan dejado de fabricarse tales piezas. Para la reparación del monitor, EIZO y los distribuidores utilizarán repuestos que cumplan con nuestros estándares de control de calidad. Si no se puede reparar la unidad debido a su estado o si se han agotado las existencias de una pieza importante, EIZO y sus distribuidores podrían ofrecerle sustituirlo por un producto con rendimiento equivalente en lugar de repararlo.

La Garantía es válida sólo en los países y territorios donde están ubicados los Distribuidores. La Garantía no restringe ningún derecho legal del Comprador original.

A pesar de las estipulaciones de esta Garantía, EIZO y sus Distribuidores no tendrán obligación alguna bajo esta Garantía en ninguno de los casos expuestos a continuación:

- (a) Cualquier defecto del Producto causado por daños en el transporte, modificación, alteración, abuso, uso incorrecto, accidente, instalación incorrecta, desastre, mantenimiento incorrecto y/o reparación indebida realizada por un tercero que no sea EIZO o sus Distribuidores.
- (b) Cualquier incompatibilidad del Producto debida a posibles innovaciones técnicas y/o reglamentaciones.
- (c) Cualquier deterioro del sensor.
- (d) Cualquier deterioro en el rendimiento de la visualización causado por fallos en las piezas consumibles como el panel LCD y/o la "Backlight", etc. (p. ej. cambios de uniformidad del brillo, cambios de color, cambios de uniformidad del color, defectos de píxeles, incluyendo píxeles muertos, etc.).
- (e) Cualquier deterioro del Producto causado por el uso continuado con un brillo superior al recomendado en el Manual del usuario.
- (f) Cualquier defecto del Producto causado por un equipo externo.
- (g) Cualquier defecto del Producto en el que haya sido alterado o borrado el número de serie original.
- (h) Cualquier deterioro normal del Producto, y en particular de las piezas consumibles, accesorios y demás (p. ej. botones, piezas giratorias, cables, Manual del usuario, etc.).
- (i) Cualquier deformación, decoloración y/o alabeo del exterior del Producto incluida la superficie del panel LCD.

Para obtener servicio en los términos de esta Garantía, el Producto deberá ser enviado por el Comprador original, a su Distribuidor local, con el transporte previamente pagado, en el embalaje original u otro embalaje adecuado que ofrezca el mismo grado de protección, asumiendo el riesgo de daños y/o pérdida del Producto durante el transporte. El Comprador original deberá presentar un comprobante de compra del Producto en el que se refleje la fecha de compra del mismo cuando lo solicite el servicio de Garantía.

El Período de garantía para cualquier Producto reemplazado y/o reparado en los términos de esta Garantía expirará al vencer el Período de garantía original.

EIZO O LOS DISTRIBUIDORES AUTORIZADOS DE EIZO NO SE RESPONSABILIZAN DE NINGÚN DAÑO O PÉRDIDA QUE PUEDAN SUFRIR LOS DATOS U OTRA INFORMACIÓN ALMACENADA EN CUALQUIER MEDIO O CUALQUIER PARTE DE CUALQUIER PRODUCTO DEVUELTO A EIZO O A LOS DISTRIBUIDORES DE EIZO PARA SU REPARACIÓN.

EIZO Y LOS DISTRIBUIDORES AUTORIZADOS DE EIZO NO OFRECEN NINGUNA OTRA GARANTÍA, IMPLÍCITA NI EXPLÍCITA, CON RESPECTO AL PRODUCTO Y A SU CALIDAD, RENDIMIENTO, COMERCIABILIDAD E IDONEIDAD PARA CUALQUIER USO EN PARTICULAR. EN NINGÚN CASO SERÁN EIZO O LOS DISTRIBUIDORES AUTORIZADOS DE EIZO RESPONSABLES DE NINGÚN DAÑO EMERGENTE, INDIRECTO, ESPECIAL, INHERENTE O CUALQUIERA QUE SEA (INCLUYENDO, SIN LIMITACIÓN, DAÑOS POR LUCRO CESANTE, INTERRUPCIÓN DE LA ACTIVIDAD COMERCIAL, PÉRDIDA DE INFORMACIÓN COMERCIAL O CUALQUIER OTRA PÉRDIDA PECUNIARIA) QUE SE DERIVE DEL USO O IMPOSIBILIDAD DE USO DEL PRODUCTO O EN RELACIÓN CON EL PRODUCTO, YA SEA BASADO EN CONTRATO, POR AGRAVIO, NEGLIGENCIA, ESTRICTA RESPONSABILIDAD O CUALQUIERA QUE SEA, AUN CUANDO SE HAYA ADVERTIDO A EIZO O A LOS DISTRIBUIDORES DE EIZO DE LA POSIBILIDAD DE TALES DAÑOS. ESTA EXCLUSIÓN TAMBIÉN ABARCA CUALQUIER RESPONSABILIDAD QUE PUEDA DERIVARSE DE RECLAMACIONES HECHAS POR UN TERCERO CONTRA EL COMPRADOR ORIGINAL. LA ESENCIA DE ESTA ESTIPULACIÓN ES LIMITAR LA RESPONSABILIDAD POTENCIAL DE EIZO Y LOS DISTRIBUIDORES QUE PUDIERA DERIVARSE DE ESTA GARANTÍA LIMITADA Y/O VENTAS.

GARANZIA LIMITATA

EIZO Corporation (a cui si farà riferimento da qui in poi con “**EIZO**”) ed i Distributori autorizzati da EIZO (a cui si farà riferimento da qui in poi con “**Distributori**”) garantiscono, secondo i termini di questa garanzia limitata (a cui si farà riferimento da qui in poi con “**Garanzia**”) all’acquirente originale (a cui si farà riferimento da qui in poi con “**Acquirente originale**”) che ha acquistato il prodotto specificato in questo documento (a cui si farà riferimento da qui in poi con “**Prodotto**”) da EIZO o dai suoi Distributori, che EIZO e i distributori, a loro discrezione, ripareranno o sostituiranno il Prodotto senza addebito se l’Acquirente originale trova, entro il periodo della Garanzia (definito sotto), che il Prodotto malfunziona e si è danneggiato nel corso del suo normale utilizzo osservando le indicazioni del manuale di istruzioni allegato al Prodotto (a cui si farà riferimento da qui in poi con “**Manuale utente**”).

La presente Garanzia è limitata a (i) cinque (5) anni a partire dalla data d’acquisto del Prodotto o (ii) allo scadere di 30.000 ore d’utilizzo del Prodotto (a cui si farà riferimento da qui in poi con “**Periodo di Garanzia**”). Tuttavia, la luminosità del Prodotto sarà garantita solo se il Prodotto è stato utilizzato con la luminosità consigliata descritta nel Manuale utente. Il Periodo di Garanzia per la luminosità è inoltre limitato a cinque (5) anni dalla data di acquisto del Prodotto, a condizione che il tempo di utilizzo sia inferiore o uguale a 10.000 ore. EIZO e i suoi Distributori non si assumono alcuna responsabilità e non hanno alcun obbligo riguardo al Prodotto verso l’Acquirente originale o terzi diversi da quelli relativi a questa Garanzia.

EIZO e i distributori cesseranno lo stoccaggio dei componenti (tranne le parti relative al progetto) del prodotto dopo sette (7) anni dall’interruzione della produzione di tali componenti. Per la riparazione del monitor, EIZO e i Distributori utilizzeranno parti di ricambio conformi ai nostri standard di controllo della qualità. Se l’unità non può essere riparata a causa delle sue condizioni o dell’esaurimento scorte di un componente rilevante, EIZO e i distributori potrebbero offrire la sostituzione con un prodotto con prestazioni equivalenti piuttosto ripararlo.

La Garanzia è valida soltanto nei paesi dove ci sono i Distributori EIZO. La Garanzia non limita alcun diritto legale dell’Acquirente originale.

Indipendentemente da qualsiasi altra condizione di questa Garanzia, EIZO e i suoi Distributori non avranno alcun obbligo derivante da questa Garanzia in ognuno dei casi elencati di seguito:

- (a) Qualsiasi difetto del Prodotto causato da danni di trasporto, modifiche, alterazioni, abusi, usi impropri, incidenti, installazione errata, calamità, manutenzione errata e/o riparazioni improprie eseguite da terze parti che non siano EIZO o i suoi Distributori.
- (b) Qualsiasi incompatibilità del Prodotto dovuta a possibili innovazioni tecniche e/o normative.
- (c) Qualsiasi deterioramento del sensore.
- (d) Qualsiasi deterioramento delle prestazioni dello schermo causato dal deterioramento delle parti consumabili, come il pannello LCD e/o la retroilluminazione, ecc. (per esempio: i cambiamenti di uniformità della luminosità, i cambiamenti di colore, i cambiamenti di uniformità del colore, i difetti dei pixel, inclusi i pixel bruciati, ecc.).
- (e) Qualsiasi deterioramento del Prodotto causato dal suo utilizzo ad una luminosità più alta di quella raccomandata nel Manuale utente.
- (f) Qualsiasi difetto del Prodotto causato da apparecchiature esterne.
- (g) Qualsiasi difetto del Prodotto in cui il numero di serie originale sia stato alterato o rimosso.
- (h) Qualsiasi normale deterioramento del Prodotto, in particolar modo nelle sue parti di consumo, accessori, e/o attacchi (per esempio: tasti, parti rotanti, cavi, Manuale dell’utente, ecc.).
- (i) Qualsiasi tipo di deformazione, scolorimento, e/o di involucro esterno del Prodotto inclusa la superficie del pannello LCD.

Per ricevere assistenza tecnica con questa Garanzia, l’Acquirente originale deve inviare il Prodotto, con trasporto pre-pagato, nella sua confezione originale o altra confezione adeguata che fornisce un livello analogo di protezione, assumendosi il rischio di danni e/o perdita in transito, al Distributore locale. L’Acquirente originale deve presentare la prova di acquisto che stabilisce la data di acquisto del Prodotto quando richiede servizio sotto Garanzia.

Il Periodo di garanzia per qualsiasi Prodotto sostituito e/o riparato sotto questa Garanzia scade alla fine del Periodo di garanzia originale.

EIZO O I SUOI DISTRIBUTORI NON SONO RESPONSABILI PER QUALSIASI DANNO O PERDITA DI DATI O ALTRE INFORMAZIONI MEMORIZZATI SU QUALSIASI SUPPORTO O QUALSIASI PARTE DI QUALSIASI PRODOTTO INVIATO A EIZO O I SUOI DISTRIBUTORI PER RIPARAZIONI.

EIZO E I SUOI DISTRIBUTORI NON OFFRONO ALCUNA GARANZIA ADDIZIONALE, IMPLICITA O ESPlicita, RIGUARDO IL PRODOTTO E LA SUA QUALITÀ, PRESTAZIONI, VENDIBILITÀ O APPROPRIATEZZA PER QUALSIASI USO PARTICOLARE. IN NESSUN CASO EIZO O I DISTRIBUTORI EIZO AUTORIZZATI SARANNO RESPONSABILI PER QUALSIASI DANNO ACCIDENTALE, INDIRECTO, SPECIALE, CONSEGUENTE O DI QUALSIASI ALTRA NATURA (INCLUSI, SENZA LIMITI, DANNI PER PERDITA DI PROFITTI, INTERRUZIONE DELLE ATTIVITÀ, PERDITA DI INFORMAZIONI D’AFFARI O QUALSIASI ALTRA PERDITA PECUNIARIA) DERIVANTI DALL’USO O DALL’IMPOSSIBILITÀ DI USARE IL PRODOTTO O IN QUALSIASI RELAZIONE AL PRODOTTO, SIA SU BASE DI CONTRATTO, TORTO, NEGLIGENZA, STRETTA RESPONSABILITÀ O ALTRIMENTI, ANCHE SE EIZO O I DISTRIBUTORI EIZO AUTORIZZATI SONO STATI AVVERTITI DELLA POSSIBILITÀ DI TALI DANNI. QUESTA ESCLUSIONE INCLUDE ANCHE QUALSIASI RESPONSABILITÀ CHE POSSA INSORGERE DA RECLAMI DI TERZI CONTRO L’ACQUIRENTE ORIGINALE. L’ESSENZA DI QUESTO PROVVEDIMENTO È LIMITARE LA RESPONSABILITÀ POTENZIALE DI EIZO E DEI DISTRIBUTORI DERIVANTE DA QUESTA GARANZIA LIMITATA E/O DALLE VENDITE.

BEGRÄNSAD GARANTI

EIZO Corporation (nedan kallat "**EIZO**") och EIZOs auktoriserade distributörer (nedan kallade "**Distributörer**") garanterar i enlighet med villkoren i denna begränsade garanti (nedan kallad "**Garantin**") den ursprunglige köparen (nedan kallad den "**Ursprunglige köparen**") som köpte den i dokumentet specificerade produkten (nedan kallad "**Produkten**") från EIZO eller Distributörer, att EIZO eller Distributörer enligt eget gottfinnande kostnadsfritt antingen reparera eller byta ut den defekta Produkten om den Ursprunglige köparen inom Garantiperioden (definieras nedan) upptäcker att Produkten fungerar felaktigt eller skadas under normal användning av Produkten i enlighet med beskrivningen i bruksanvisningen (nedan kallad "**Bruksanvisning**").

Giltighetsperioden för denna garanti är begränsad till (i) fem (5) år från datumet för Produktens inköp eller, om detta inträffar tidigare, begränsat till utlöpanget av (ii) 30 000 timmars användning av Produkten (häri kallad "**Garantiperioden**"). Ljusstyrkan på produkten är emellertid endast garanterad om produkten har använts inom den rekommenderade ljusstyrka som beskrivs i Användarmanualen. Garantiperioden för ljusstyrkan är även begränsad till fem (5) år från produktens inköpsdatum såvida användningstiden är mindre än eller lika med 10 000 timmar. EIZO och Distributörer ska inte under några villkor ha något annat ansvar än vad som anges i denna garanti gällande Produkten i relation till den Ursprunglige köparen eller tredje part.

EIZO och dess leverantörer slutar lagerföra delar (utom designdelar) till produkten sju (7) år efter att delen i fråga slutar tillverkas. När skärmen repareras använder EIZO och distributörer reservdelar som uppfyller våra kvalitetsstandarder. Om enheten inte kan repareras på grund av skicket eller att en del inte finns i lager kan EIZO och dess leverantörer erbjuda sig att byta ut produkten mot en produkt med likvärdig prestanda istället för att reparera den.

Garantin är endast giltig i de länder där det finns Distributörer. Garantin begränsar inte några av den Ursprunglige köparens lagstadgade rättigheter.

Oavsett andra villkor i denna garanti ska inte EIZO Distributörer under några villkor ha något ansvar i något av de fall som beskrivs nedan:

- (a) När någon bristfällighet hos Produkten kan härledas till att ha uppstått vid frakt, modifiering, ändring, felaktigt handhavande, olycka, felaktig installation, katastrof, felaktigt underhåll och/eller felaktig reparation utförd av tredje part annan än EIZO och Distributörer.
- (b) Alla former av inkompatibilitet hos Produkten på grund av möjliga tekniska innovationer och/eller bestämmelser.
- (c) Alla försämringar av sensorn.
- (d) Alla försämringar av bildens prestanda beroende på förbrukningsdelar så som LCD-panel och/eller bakgrundsbelysning etc. (t.ex. ändringar i jämnhet i ljusstyrka, färg, färgjämnhet, defekta pixlar och/eller fast lysande pixlar etc.).
- (e) Alla försämringar av Produkten orsakat av användning av en högre ljusstyrka än den i Bruksanvisningen rekommenderade ljusstyrkan.
- (f) Alla defekter hos Produkten som orsakats av extern utrustning.
- (g) Alla defekter hos Produkten på vilken det ursprungliga serienumret har ändrats eller avlägsnats.
- (h) All normal försämring av Produkten, speciellt förbrukningsartiklar, tillbehör och/eller yttre delar (t.ex. knappar, roterande delar, kablar, Bruksanvisningen etc.).
- (i) Varje deformation, missfärgning och/eller skevhet av Produktens yttre inklusive ytan på LCD-panelen.

För att erhålla service under denna garanti måste den Ursprunglige köparen (med hänseende till risken för skada och/eller förlust under transport) leverera Produkten till närmaste Distributör med förebetalad frakt, i dess ursprungliga förpackning eller annan fullgod förpackning som ger likvärdigt skydd. Den Ursprunglige köparen måste kunna visa inköpsbevis för Produkten som klargör Produktens inköpsdatum vid begäran av garantiservice.

Garantiperioden för alla utbytta och/eller reparerade produkter under denna garanti skall upphöra vid utgången av den ursprungliga Garantiperioden.

EIZO ELLER DISTRIBUTÖRER ÄR INTE ANSVARIGA FÖR NÅGON FORM AV SKADA ELLER FÖRLUST AV DATA ELLER ANNAN INFORMATION SOM HAR LAGRATS I NÅGON FORM AV MEDIA ELLER ANNAN DEL AV NÅGON PRODUKT SOM HAR RETURNERATS TILL EIZO ELLER DISTRIBUTÖRER FÖR REPARATION.

EIZO OCH DISTRIBUTÖRERNA GARANTERAR INGET, UTTRYCKLIGEN ELLER UNDERFÖRSTÅTT, VAD BETRÄFFAR PRODUKTEN OCH DESS KVALITET, PRESTANDA, SÄLJBARHET ELLER LÄMPLIGHET FÖR NÅGON FORM AV SPECIELL ANVÄNDNING. UNDER INGA OMSTÄNDIGHETER SKALL EIZO ELLER DISTRIBUTÖRERNA HÅLLAS ANSVARIGA FÖR NÅGRA SOM HELST UNDERORDNADE, INDIREKTA, SPECIELLA, DÄRAV FÖLJANDE ELLER ÖVRIGA SKADOR (INKLUSIVE, UTAN BEGRÄNSNING TILL, SKADOR FÖR FÖRLUST AV INKOMST, AVBRUTEN AFFÄRSRÖRELSE, FÖRLUST AV AFFÄRSINFORMATION ELLER ANNAN SÄRSKILD FÖRLUST) SOM UPPSTÅTT SOM ETT RESULTAT AV ANVÄNDNING ELLER OFÖRMÅGA ATT ANVÄNDA PRODUKTEN ELLER I NÅGON FORM AV ANSLUTNING TILL PRODUKTERNA, VARE SIG DETTA GRUNDAS PÅ KONTRAKT, ÅTALBAR HANDLING, FÖRSUMLIGHET, ANSVARSSKYLDIGHET ELLER ANNAT, ÄVEN OM EIZO ELLER DISTRIBUTÖRERNA HAR INFORMERATS BETRÄFFANDE MÖJLIGHET ATT SÅDANA SKADOR FÖRELIGGER. DETTA UNDANTAG OMFATTAR ÄVEN ALL FORM AV ANSVARSSKYLDIGHET SOM KAN UPPSTÅ GENOM EN TREDJE PARTS ANSPRÅK GENTEMOT DEN URSPRUNGLIGE KÖPAREN. GRUNDBESTÄNDSDELEN I BESTÄMMELEN ÄR ATT BEGRÄNSA DET EVENTUELLA ANSVARSTAGANDET FÖR EIZO OCH DISTRIBUTÖRERNA SOM KAN UPPSTÅ GENOM DENNA BEGRÄNSADE GARANTI OCH/ELLER FÖRSÄLJNING.

ΠΕΡΙΟΡΙΣΜΕΝΗ ΕΓΓΥΗΣΗ

Η EIZO Corporation (στο εξής «**EIZO**») και οι διανομείς που εξουσιοδοτεί η EIZO (στο εξής «**Διανομείς**») παρέχουν εγγύηση, υποκείμενη και σύμφωνα με τους όρους της παρούσας περιορισμένης εγγύησης (στο εξής «**Εγγύηση**»), στον αρχικό αγοραστή (στο εξής «**Αρχικός Αγοραστής**») ο οποίος αγόρασε το προϊόν που καθορίζεται στο παρόν έγγραφο (στο εξής «**Προϊόν**») από την EIZO ή τους Διανομείς, η οποία εξασφαλίζει ότι η EIZO και οι Διανομείς, σύμφωνα με τη διακριτή ευχέρειά τους, είτε θα επισκευάσουν είτε θα αντικαταστήσουν το Προϊόν χωρίς χρέωση εάν ο Αρχικός Αγοραστής αντιληφθεί εντός της Περιόδου Εγγύησης (ορίζεται κατωτέρω) ότι το Προϊόν δυσλειτουργεί ή έχει υποστεί βλάβη κατά τη διάρκεια κανονικής χρήσης του Προϊόντος σύμφωνα με την περιγραφή στο εγχειρίδιο χρήσης που συνοδεύει το Προϊόν (στο εξής «**Εγχειρίδιο Χρήστη**»).

Η περίοδος της παρούσας Εγγύησης είναι (i) πέντε (5) έτη από την ημερομηνία αγοράς του Προϊόντος, ή, στη λήξη των (ii) 30.000 ωρών χρήσης του Προϊόντος (στο εξής «**Περίοδος Εγγύησης**»). Ωστόσο, η φωτεινότητα του Προϊόντος θα πρέπει να καλύπτεται από την εγγύηση μόνο αν το Προϊόν έχει χρησιμοποιηθεί στη συνιστώμενη φωτεινότητα που περιγράφεται στο Εγχειρίδιο χρήσης. Η Περίοδος Εγγύησης για τη φωτεινότητα περιορίζεται επίσης σε πέντε (5) χρόνια από την ημερομηνία αγοράς του Προϊόντος με την προϋπόθεση ότι ο χρόνος χρήσης είναι μικρότερος ή ίσος με 10.000 ώρες. Η EIZO και οι Διανομείς δεν φέρουν καμία ευθύνη ή υποχρέωση όσον αφορά το Προϊόν σε σχέση με τον Αρχικό Αγοραστή ή οποιοδήποτε τρίτο μέρος, ούτε άλλη ευθύνη διαφορετική από αυτήν που παρέχεται στην παρούσα Εγγύηση.

Η EIZO και οι διανομείς της θα πάψουν να διατηρούν αποθέματα εξαρτημάτων (εκτός από τα εξαρτήματα σχεδιασμού) του προϊόντος μόλις περάσουν επτά (7) χρόνια από την παραγωγή των εν λόγω εξαρτημάτων. Κατά την επισκευή της οθόνης, η EIZO και οι Διανομείς θα χρησιμοποιήσουν ανταλλακτικά επισκευής που συμμορφώνονται με τα πρότυπά μας για τη Διασφάλιση Ποιότητας. Αν δεν είναι εφικτή η επισκευή της μονάδας λόγω της κατάστασής της ή λόγω έλλειψης αποθεμάτων κάποιου σχετικού εξαρτήματος, η EIZO και οι διανομείς της ενδέχεται να σας προσφέρουν τη δυνατότητα αντικατάστασής της με προϊόν ισοδύναμων επιδόσεων αντί να την επισκευάσουν.

Η Εγγύηση ισχύει μόνο σε χώρες ή περιοχές όπου βρίσκονται οι Διανομείς. Η Εγγύηση δεν περιορίζει οποιαδήποτε νόμιμα δικαιώματα του Αρχικού Αγοραστή.

Λαμβανομένης υπόψη κάθε διάταξης της παρούσας Εγγύησης, η EIZO και οι Διανομείς δεν θα έχουν καμία απολύτως υποχρέωση σύμφωνα με την παρούσα Εγγύηση σε οποιαδήποτε από τις περιπτώσεις που διατυπώνονται κατωτέρω:

- (α) Τυχόν ελάττωμα του Προϊόντος που προκαλείται από ζημιά κατά τη μεταφορά, τροποποίηση, αλλαγή, κατάχρηση, λανθασμένη χρήση, ατύχημα, λανθασμένη εγκατάσταση, καταστροφή, εσφαλμένη συντήρηση ή/και λανθασμένη επισκευή από τρίτο μέρος εκτός της EIZO και των Διανομέων,
- (β) Τυχόν ασυμβατότητα του Προϊόντος λόγω πιθανών τεχνικών καινοτομιών ή/και κανονισμών,
- (γ) Τυχόν επιδείνωση του αισθητήρα,
- (δ) Τυχόν επιδείνωση της απόδοσης οθόνης που προκαλείται από τη φθορά αναλώσιμων εξαρτημάτων όπως της οθόνης LCD ή/και του φωτός υποβάθρου, κτλ. (π.χ. αλλαγές στην ομοιομορφία φωτεινότητας, αλλαγές στο χρώμα, αλλαγές στην ομοιομορφία χρώματος, ελαττώματα σε pixel περιλαμβανομένων των καμένων pixel, κτλ.),
- (ε) Τυχόν επιδείνωση του Προϊόντος λόγω χρήσης σε υψηλότερη φωτεινότητα από τη συνιστώμενη φωτεινότητα που περιγράφεται στο Εγχειρίδιο Χρήστη,
- (στ) Τυχόν ελάττωμα του Προϊόντος που προκαλείται από εξωτερικό εξοπλισμό,
- (ζ) Τυχόν ελάττωμα του Προϊόντος στο οποίο έχει τροποποιηθεί ή αφαιρεθεί ο γνήσιος αριθμός σειράς,
- (η) Τυχόν φυσιολογική φθορά του προϊόντος, ιδιαίτερα αυτής των αναλώσιμων, των αξεσουάρ ή/και των προσαρτημάτων (π.χ. κουμπιά, περιστρεφόμενα μέρη, καλώδια, Εγχειρίδιο Χρήστη, κτλ.), και
- (θ) Τυχόν παραμόρφωση, αποχρωματισμό ή/και διαστρέβλωση του εξωτερικού μέρους του προϊόντος, περιλαμβανομένης της επιφάνειας της οθόνης LCD.

Ο Αρχικός Αγοραστής για να δικαιούται υπηρεσίες επισκευής σύμφωνα με την Εγγύηση, θα πρέπει να παραδώσει το Προϊόν, με πληρωμένα τα μεταφορικά έξοδα, στην αρχική του συσκευασία ή σε άλλη επαρκή συσκευασία με ισότιμο βαθμό προστασίας, αναλαμβάνοντας τον κίνδυνο βλάβης ή/και απώλειας κατά τη μεταφορά, στον τοπικό Διανομέα. Ο Αρχικός Αγοραστής όταν ζητά υπηρεσίες επισκευής σύμφωνα με την Εγγύηση, θα πρέπει να προσκομίζει την απόδειξη αγοράς του Προϊόντος και την ημερομηνία της αγοράς.

Η Περίοδος Εγγύησης για οποιοδήποτε αντικατεστημένο ή/και επισκευασμένο προϊόν σύμφωνα με την παρούσα Εγγύηση λήγει στο τέλος της αρχικής Περιόδου Εγγύησης.

Η EIZO Ή ΟΙ ΔΙΑΝΟΜΕΙΣ ΔΕΝ ΕΥΘΥΝΟΝΤΑΙ ΓΙΑ ΟΠΟΙΑΔΗΠΟΤΕ ΒΛΑΒΗ Ή ΑΠΩΛΕΙΑ ΔΕΔΟΜΕΝΩΝ Ή ΑΛΛΩΝ ΠΛΗΡΟΦΟΡΙΩΝ ΠΟΥ ΑΠΟΘΗΚΕΥΟΝΤΑΙ ΣΕ ΟΠΟΙΟΔΗΠΟΤΕ ΜΕΣΟ Ή ΟΠΟΙΟΔΗΠΟΤΕ ΑΛΛΟ ΜΕΡΟΣ ΣΕ ΟΠΟΙΟΔΗΠΟΤΕ ΠΡΟΪΟΝ ΠΟΥ ΕΠΙΣΤΡΕΦΕΤΑΙ ΣΤΗΝ EIZO Ή ΣΕ ΔΙΑΝΟΜΕΑ ΓΙΑ ΕΠΙΣΚΕΥΗ.

Η EIZO ΚΑΙ ΟΙ ΔΙΑΝΟΜΕΙΣ ΔΕΝ ΠΑΡΕΧΟΥΝ ΚΑΜΙΑ ΠΕΡΑΙΤΕΡΩ ΕΓΓΥΗΣΗ, ΡΗΤΗ Ή ΣΥΝΕΠΑΓΟΜΕΝΗ, ΟΣΟΝ ΑΦΟΡΑ ΤΟ ΠΡΟΪΟΝ ΚΑΙ ΤΗΝ ΠΟΙΟΤΗΤΑ, ΤΗΝ ΑΠΟΔΟΣΗ, ΤΗΝ ΕΜΠΟΡΕΥΣΙΜΟΤΗΤΑ Ή ΤΗΝ ΚΑΤΑΛΛΗΛΟΤΗΤΑ ΤΟΥ ΓΙΑ ΟΠΟΙΑΔΗΠΟΤΕ ΣΥΓΚΕΚΡΙΜΕΝΗ ΧΡΗΣΗ. ΣΕ ΚΑΜΙΑ ΠΕΡΙΠΤΩΣΗ Η EIZO Ή ΟΙ ΔΙΑΝΟΜΕΙΣ ΔΕΝ ΘΑ ΕΥΘΥΝΟΝΤΑΙ ΓΙΑ ΚΑΜΙΑ ΑΠΟΛΥΤΩΣ ΤΥΧΑΙΑ, ΕΜΜΕΣΗ, ΕΙΔΙΚΗ, ΣΥΝΕΠΑΓΟΜΕΝΗ Ή ΑΛΛΗ ΒΛΑΒΗ (ΠΕΡΙΛΑΜΒΑΝΟΜΕΝΩΝ, ΜΕΤΑΞΥ ΑΛΛΩΝ, ΒΛΑΒΩΝ Ή ΑΠΩΛΕΙΑΣ ΚΕΡΔΩΝ, ΔΙΑΚΟΠΗΣ ΕΠΙΧΕΙΡΗΜΑΤΙΚΩΝ ΔΡΑΣΤΗΡΙΟΤΗΤΩΝ, ΑΠΩΛΕΙΑΣ ΕΠΙΧΕΙΡΗΜΑΤΙΚΩΝ ΠΛΗΡΟΦΟΡΙΩΝ Ή ΤΥΧΟΝ ΑΛΛΗΣ ΧΡΗΜΑΤΙΚΗΣ ΑΠΩΛΕΙΑΣ) ΠΟΥ ΠΡΟΚΥΠΤΕΙ ΑΠΟ ΤΗ ΧΡΗΣΗ Ή ΤΗΝ ΑΝΙΚΑΝΟΤΗΤΑ ΧΡΗΣΗΣ ΤΟΥ ΠΡΟΪΟΝΤΟΣ Ή ΤΥΧΟΝ ΑΛΛΗΣ ΣΥΝΔΕΣΗΣ ΜΕ ΤΟ ΠΡΟΪΟΝ, ΕΙΤΕ ΒΑΣΙΖΕΤΑΙ ΣΕ ΣΥΜΒΟΛΑΙΟ, ΒΛΑΒΗ, ΑΜΕΛΕΙΑ, ΑΥΣΤΗΡΗ ΕΥΘΥΝΗ Ή ΕΙΔΑΛΛΩΣ, ΑΚΟΜΗ ΚΙ ΕΑΝ Η EIZO Ή ΟΙ ΔΙΑΝΟΜΕΙΣ ΕΝΗΜΕΡΩΘΟΥΝ ΓΙΑ ΤΗΝ ΠΙΘΑΝΟΤΗΤΑ ΤΕΤΟΙΩΝ ΖΗΜΙΩΝ. Η ΕΞΑΙΡΕΣΗ ΑΥΤΗ ΠΕΡΙΛΑΜΒΑΝΕΙ ΕΠΙΣΗΣ ΟΠΟΙΑΔΗΠΟΤΕ ΕΥΘΥΝΗ ΕΝΔΕΧΕΤΑΙ ΝΑ ΠΡΟΚΥΨΕΙ ΑΠΟ ΑΞΙΩΣΕΙΣ ΤΡΙΤΟΥ ΜΕΡΟΥΣ ΚΑΤΑ ΤΟΥ ΑΡΧΙΚΟΥ ΑΓΟΡΑΣΤΗ. Η ΟΥΣΙΑ ΤΟΥ ΟΡΟΥ ΑΥΤΟΥ ΕΙΝΑΙ ΝΑ ΠΕΡΙΟΡΙΣΕΙ ΤΗΝ ΠΙΘΑΝΗ ΕΥΘΥΝΗ ΤΗΣ EIZO ΚΑΙ ΤΩΝ ΔΙΑΝΟΜΕΩΝ ΠΟΥ ΠΡΟΚΥΠΤΕΙ ΑΠΟ ΤΗΝ ΠΑΡΟΥΣΑ ΕΓΓΥΗΣΗ Ή/ΚΑΙ ΤΙΣ ΠΩΛΗΣΕΙΣ.

ОГРАНИЧЕННАЯ ГАРАНТИЯ

EIZO Corporation (называемая в дальнейшем “EIZO”) и авторизованные EIZO дистрибуторы (называемые в дальнейшем “Дистрибуторы”) гарантируют, в соответствии с условиями и пунктами этой ограниченной гарантии (называемой в дальнейшем “Гарантия”), первичному покупателю (называемому в дальнейшем “Первоначальный покупатель”), который приобрел у EIZO или Дистрибуторов продукт, указанный в этом документе (называемый в дальнейшем “Продукт”), что EIZO или Дистрибуторы на свое усмотрение либо бесплатно отремонтируют, либо бесплатно заменят Продукт, если Первоначальный покупатель признает в пределах Гарантийного срока (определенного ниже), что Продукт неисправен или он поврежден процессе нормального использования продукта в соответствии с описанием в инструкции по эксплуатации, прилагаемой к Продукту (называемой в дальнейшем “Руководство пользователя”).

Гарантийный период ограничен сроком (i) пять (5) лет от даты приобретения Продукта или ограничен сроком (ii) 30 000 часов использования Продукта (называемый в дальнейшем “Гарантийный период”). Однако яркость Продукта может быть гарантирована только, если Продукт использовался с рекомендованной яркостью, указанной в Руководстве Пользователя. Гарантийный период для яркости также ограничен сроком пять (5) лет от даты приобретения Продукта и время его использования не превышает 10 000 часов. EIZO и Дистрибуторы не несут никакой ответственности и не берут обязательств относительно Продукта по отношению к Первоначальному покупателю или по отношению к любым третьим сторонам, кроме обязательств, оговоренных в этой Гарантии.

Компания EIZO и ее дистрибуторы хранят детали изделия (за исключением деталей внешней конструкции) не более 7 (семи) лет после прекращения его выпуска. В случае ремонта монитора EIZO и Дистрибуторы будут использовать запчасти, которые соответствуют нашим стандартам QC (контроль качества). Если устройство невозможно отремонтировать из-за его состояния или отсутствия нужной детали, то вместо ремонта компания EIZO и ее дистрибуторы могут предлагать замену неисправного устройства на устройство с аналогичными характеристиками.

Гарантия действительна только в странах или регионах, где расположены Дистрибуторы. Гарантия не ограничивает никакие законные права Первоначального покупателя.

Несмотря на другие условия этой Гарантии EIZO и Дистрибуторы не несут никаких обязательств согласно этой Гарантии в любом из перечисленных ниже случаев:

- (а) Любые дефекты Продукта, вызванные повреждениями при перевозке, модификацией, изменением, неправильным обращением, неправильным использованием, авариями, неправильной установкой, стихийными бедствиями, неправильным уходом и/или неправильным ремонтом третьей стороной, отличной от EIZO или Дистрибуторов;
- (б) Любые несовместимости Продукта из-за технических усовершенствований и/или изменения технических норм;
- (в) Любое повреждение датчика;
- (г) Любые ухудшения работы дисплея, вызванные изнашиванием невосстановимых частей, таких как панель ЖКД и/или подсветка и т.д. (например, изменение в равномерности яркости, изменение в цветности, изменение в равномерности цветности, изменение в пикселях, включая выгоревшие пиксели и т.д.);
- (д) Любые ухудшения Продукта, вызванные использованием при яркости, повышенной по сравнению с рекомендованной яркостью, описанной в Руководстве пользователя;
- (е) Любые дефекты Продукта, вызванные внешним оборудованием;
- (ж) Любые дефекты Продукта, при которых оригинальный серийный номер был изменен или удален;
- (з) Любые естественные ухудшения продукта, в частности, вызванные износом расходных частей, принадлежностей и/или приспособлений (например, кнопок, вращающихся частей, кабелей, Руководства пользователя и т.д.); и
- (и) Любые деформации, изменения цвета и/или коробления внешней поверхности продукта, включая поверхность панели ЖКД.

Чтобы получить техническое обслуживание в рамках Гарантии, Первоначальный покупатель должен доставить Продукт местному Дистрибутору, оплатив перевозку, в его оригинальной упаковке или в другой соответствующей упаковке, обеспечивающей равноценную степень защиты, принимая во внимание риск повреждения и/или утерю при транспортировке. При запросе технического обслуживания в рамках Гарантии Первоначальный покупатель должен предоставить свидетельство покупки продукта и даты покупки.

Гарантийный период для любого замененного и/или отремонтированного продукта в рамках Гарантии истекает в конце завершения срока действия оригинального Гарантийного периода.

EIZO ИЛИ ДИСТРИБУТОРЫ НЕ НЕСУТ ОТВЕТСТВЕННОСТИ ЗА ЛЮБЫЕ ПОВРЕЖДЕНИЯ ИЛИ УТЕРЮ ДАННЫХ ИЛИ ДРУГОЙ ИНФОРМАЦИИ, ХРАНЯЩИХСЯ НА КАКИХ-ЛИБО НОСИТЕЛЯХ ИНФОРМАЦИИ ИЛИ НА ЛЮБЫХ ДРУГИХ ЧАСТЯХ ПРОДУКТА, КОТОРЫЙ ВОЗВРАЩЕН EIZO ИЛИ ДИСТРИБУТОРАМ ДЛЯ РЕМОНТА.

EIZO И ДИСТРИБУТОРЫ НЕ ДАЮТ НИКАКОЙ ДАЛЬНЕЙШЕЙ ГАРАНТИИ, ВЫРАЖЕННОЙ ИЛИ ПОДРАЗУМЕВАЕМОЙ, ОТНОСИТЕЛЬНО ПРОДУКТА И ЕГО КАЧЕСТВА, ТЕХНИЧЕСКИХ ХАРАКТЕРИСТИК, ТОВАРНОСТИ ИЛИ СООТВЕТСТВИЯ ДЛЯ КАКОГО-ЛИБО ОПРЕДЕЛЕННОГО ИСПОЛЬЗОВАНИЯ. НИ ПРИ КАКИХ УСЛОВИЯХ EIZO ИЛИ ДИСТРИБУТОРЫ НЕ НЕСУТ ОТВЕТСТВЕННОСТИ ЗА ЛЮБОЙ СЛУЧАЙНЫЙ, КОСВЕННЫЙ, СПЕЦИАЛЬНЫЙ, ПОБОЧНЫЙ ИЛИ ИНОЙ УЩЕРБ (ВКЛЮЧАЯ, БЕЗ ОГРАНИЧЕНИЙ, УЩЕРБ ИЗ-ЗА НЕПОЛУЧЕННОЙ ПРИБЫЛИ, ПРЕРЫВАНИЯ БИЗНЕСА, ПОТЕРИ КОММЕРЧЕСКОЙ ИНФОРМАЦИИ ИЛИ ЛЮБЫЕ ДРУГИЕ ФИНАНСОВЫЕ ПОТЕРИ), ВОЗНИКШИЙ ИЗ-ЗА ИСПОЛЬЗОВАНИЯ ИЛИ НЕВОЗМОЖНОСТИ ИСПОЛЬЗОВАТЬ ПРОДУКТ ИЛИ В ЛЮБОЙ ДРУГОЙ СВЯЗИ С ПРОДУКТОМ, ЛИБО ОСНОВАННЫЙ НА КОНТРАКТНЫХ ОТНОШЕНИЯХ, ГРАЖДАНСКИХ ПРАВОНАРУШЕНИЯХ, НЕБРЕЖНОСТИ, ПРИЧИНЕНИЯ УЩЕРБА ТРЕТЬЕЙ СТОРОНЕ ИЛИ ЧЕМ-ЛИБО ЕЩЕ, ДАЖЕ ЕСЛИ EIZO ИЛИ ДИСТРИБУТОРЫ БЫЛИ УВЕДОМЛЕННЫ О ВОЗМОЖНОСТИ ТАКОГО УЩЕРБА. ЭТО ИСКЛЮЧЕНИЕ ТАКЖЕ ВКЛЮЧАЕТ ЛЮБЫЕ ОБЯЗАТЕЛЬСТВА, КОТОРЫЕ МОГУТ ВОЗНИКНУТЬ В РЕЗУЛЬТАТЕ ТРЕБОВАНИЙ ТРЕТЬЕЙ СТОРОНЫ В ОТНОШЕНИИ ПЕРВОНАЧАЛЬНОГО ПОКУПАТЕЛЯ. СУЩЕСТВОМ ЭТОГО ПОЛОЖЕНИЯ ЯВЛЯЕТСЯ ОГРАНИЧЕНИЕ ПОТЕНЦИАЛЬНОЙ ОТВЕТСТВЕННОСТИ EIZO И ДИСТРИБУТОРОВ, ВОЗНИКАЮЩЕЙ ИЗ-ЗА ЭТОЙ ОГРАНИЧЕННОЙ ГАРАНТИИ И/ЛИ ПРОДАЖ.

有限责任保证书

EIZO Corporation (以下简称“EIZO”)和 EIZO 授权的经销商 (以下简称“经销商”), 接受并依照本有限责任保证书 (以下简称“保证书”)之条款, 向从 EIZO 和经销商购买本文中规定产品 (以下简称“产品”)的原买方 (以下称“原买方”)提供保证:在保证期内 (规定如下), 如果原买方发现按本产品所附使用说明书 (以下简称“用户手册”)所述方式正常使用本产品过程中, 本产品出现故障或损坏, EIZO 和经销商根据其独立的判断免费修理或更换该产品。

本保证期限定为(i)自本产品购买之日起的五(5)年期间或限定为到达(ii)使用本产品 3 万小时的期限(以下简称“保证期限”)。但是, 仅按照用户手册所描述的推荐亮度使用本产品时方对产品的亮度提供保证。亮度的保证期限也限定为本产品的使用时间在 10000 小时以下 (含 10000 小时) 的条件下自购买本产品之日起的五 (5) 年。EIZO 和经销商将不向原买方或任何第三方承担本保证书所规定之外的与本产品有关的任何责任或义务。

零件停产七 (7) 年后, EIZO 及其经销商不再保留或保存产品的任何零件 (设计零件除外)。维修显示器时, EIZO 与经销商将使用符合我方质量控制标准的替换零件。若由于自身条件或缺少相关零件而不能修理设备, EIZO 和经销商可提供性能相同的更换产品, 而无需维修。

本保证书仅对于设有经销商的国家或地区有效。本保证书并不限定原买方的任何法律权利。

无论本保证书的任何其他条款如何规定, 对于任何下列情况之一, EIZO 和经销商将不承担本保证书规定责任:

- (a) 由于运输损害、改装、改动、滥用、误用、意外事故、错误安装、灾害、维护不善和 / 或由除 EIZO 和经销商以外的第三方进行不适当的修理造成本产品的任何故障。
- (b) 由于可能发生的技术变更和 / 或调整造成本产品的任何不兼容性。
- (c) 传感器的任何劣化。
- (d) 由于诸如液晶显示屏 (LCD) 和 / 或背灯等消耗品部件的老化造成的任何显示性能低劣 (如亮度均一性变化、色彩变化、色彩均一性变化、如烧伤像素等像素缺陷)。
- (e) 由于在比用户手册所推荐亮度更高的亮度下使用对本产品所造成的任何老化。
- (f) 因外部设备造成本产品的任何故障。
- (g) 因本产品的原序号被改变或消除造成本产品的任何故障。
- (h) 本产品的任何正常老化, 尤其是消耗品、附件和 / 或附加装置 (如按钮、旋转部件、电缆、用户手册等)、以及
- (i) 本产品表面包括液晶显示屏 (LCD) 表面的任何变形、变色和 / 翘曲。

为了获得本保证书规定的服务, 原买方必须使用原包装或其他具有同等保护程度的适当包装将本产品运送到当地的经销商, 并且预付运费, 承担运输中的损坏和 / 或损失的风险。要求提供本保证书规定的服务时, 原买方必须提交购买本产品和标明此购买日期的证明。

按本保证书规定进行了更换和 / 或修理的任何产品的保证期限, 将在原保证期限结束时终止。

在返回给 EIZO 和经销商进行修理后, 任何产品的任何媒体或任何部件中储存的数据或其他信息发生任何损坏或损失, 对此 EIZO 和经销商将不承担责任。

对于本产品及其质量、性能、可销售性以及对于特殊用途的适合性, EIZO 和经销商不提供其他任何明示或暗示的保证。因使用本产品或无法使用本产品或因与本产品有任何关系 (无论是否根据合同) 而造成: 任何附带的、间接的、特殊的、随之发生的或其他的损害 (包括但不限于: 利润损失、业务中断、业务信息丢失或其他任何金钱损失) 以及侵权行为、过失、严格赔偿责任或其他责任, 即使已经向 EIZO 和经销商提出了发生这些损害的可能性, 对此 EIZO 和经销商概不承担责任。本免责条款还包括因第三方向原买方提出索赔而可能发生的任何责任。本条款的本质是限定由于本有限责任保证书和 / 或销售本产品所发生的 EIZO 和经销商的潜在责任。

Recycling Information

Recycling Information

This product, when disposed of, is supposed to be collected and recycled according to your country's legislation to reduce environmental burden. When you dispose of this product, please contact a distributor or an affiliate in your country.

The contact addressees are listed on the EIZO website below.

<http://www.eizoglobal.com>

For recycling information for customers in Switzerland, please refer to the following website.

<http://www.swico.ch>

Informationen zum Thema Recycling

Dieses Produkt muss gemäß den Vorschriften Ihres Landes zur Entlastung der Umwelt recyclet werden. Wenden Sie sich bei der Entsorgung dieses Produkts an einen Verteiler oder eine Tochtergesellschaft in Ihrem Land.

Die Adressen zur Kontaktaufnahme sind auf der unten angegebenen Website von EIZO aufgeführt.

<http://www.eizoglobal.com>

Kunden in der Schweiz entnehmen Informationen zum Recycling der folgenden Website:

<http://www.swico.ch>

Informations sur le recyclage

Ce produit doit être jeté aux points de collecte prévus à cet effet et recyclé conformément à la législation de votre pays, afin de réduire l'impact sur l'environnement. Lorsque vous jetez ce produit, veuillez contacter un distributeur ou une société affiliée de votre pays.

Les adresses des distributeurs sont répertoriées sur le site Web EIZO ci-dessous.

<http://www.eizoglobal.com>

Pour les clients en Suisse, veuillez consulter le site Web suivant afin d'obtenir des informations sur le recyclage.

<http://www.swico.ch>

Información sobre reciclaje

Este producto debe desecharse y reciclarse según la legislación del país para reducir el impacto medioambiental. Cuando desee deshacerse de este producto, póngase en contacto con un distribuidor o una filial de su país.

Encontrará las direcciones de contacto en el sitio web de EIZO que se indica a continuación.

<http://www.eizoglobal.com>

Informazioni sul riciclaggio

Per lo smaltimento e il riciclaggio del presente prodotto, attenersi alle normative vigenti nel proprio paese per ridurre l'impatto ambientale. Per lo smaltimento, rivolgersi ad un distributore o un affiliato presenti nel proprio paese.

Gli indirizzi sono elencati nel sito Web EIZO riportato di seguito.

<http://www.eizoglobal.com>

Per informazioni sul riciclaggio per i clienti in Svizzera, consultare il sito Web riportato di seguito.

<http://www.swico.ch>

Återvinningsinformation

När denna produkt kasseras ska den hanteras och återvinnas enligt landets föreskrifter för att reducera miljöpåverkan. När du kasserar produkten ska du kontakta en distributör eller representant i ditt land.

Kontaktadresserna listas på EIZO-webbplatsen nedan.

<http://www.eizoglobal.com>

Πληροφορίες ανακύκλωσης

Το προϊόν αυτό, όταν απορρίπτεται, πρέπει να συλλέγεται και να ανακυκλώνεται σύμφωνα με τη νομοθεσία της χώρας σας έτσι ώστε να μην επιβαρύνει το περιβάλλον. Για να απορρίψετε το προϊόν, επικοινωνήστε με έναν αντιπρόσωπο ή μια θυγατρική εταιρεία στη χώρα σας.

Οι διευθύνσεις επικοινωνίας αναγράφονται στην τοποθεσία web της EIZO παρακάτω.

<http://www.eizoglobal.com>

Сведения по утилизации

По истечении срока службы данного продукта его следует принести на сборный пункт и утилизировать в соответствии с действующими предписаниями в вашей стране, чтобы уменьшить вредное воздействие на окружающую среду. Прежде чем выбросить данный продукт, обратитесь к дистрибьютору или в местное представительство компании в вашей стране.

Контактные адреса можно найти на веб-узле EIZO.

<http://www.eizoglobal.com>

Informatie over recycling

Wanneer u dit product wilt weggooien, moet het uit milieu-overwegingen worden verzameld en gerecycled volgens de betreffende wetgeving van uw land. Wanneer u dit product wilt weggooien, moet u contact opnemen met een distributeur of een partner in uw land.

De contactadressen worden vermeld op de volgende EIZO-website.

<http://www.eizoglobal.com>

Informação sobre reciclagem

Este produto, quando o deitar fora, deve ser recolhido e reciclado de acordo com a legislação do seu país para reduzir a poluição. Quando deitar fora este produto, contacte um distribuidor ou uma filial no seu país.

Os endereços de contacto estão listados no website do EIZO, abaixo.

<http://www.eizoglobal.com>

Oplysninger om genbrug

Dette produkt forventes ved bortskaffelse at blive indsamlet og genbrugt i overensstemmelse med lovgivningen i dit land for at reducere belastningen af miljøet. Når du bortskaffer denne produkt, skal du kontakte en distributør eller et tilknyttet selskab i dit land.

Adresserne på kontaktpersonerne er angivet på EIZO's websted nedenfor.

<http://www.eizoglobal.com>

Kierrätystä koskevia tietoja

Tuote tulee hävittää kierrättämällä maan lainsäädännön mukaisesti ympäristön kuormittumisen vähentämiseksi. Kun hävität tuotteen, ota yhteyttä jälleenmyyjään tai tytäryhtiöön maassasi.

Yhteystiedot löytyvät EIZOn Internet-sivustolta.

<http://www.eizoglobal.com>

Wykorzystanie surowców wtórnych

Ten produkt po zużyciu powinien być zbierany i przetwarzany zgodnie z krajowymi przepisami dotyczącymi ochrony środowiska. Wyrzucając ten produkt, należy skontaktować się z lokalnym dystrybutorem lub partnerem. Adresy kontaktowe można znaleźć we wskazanej poniżej witrynie internetowej firmy EIZO.

<http://www.eizoglobal.com>

Informace o recyklaci

Při likvidaci produktu musí být produkt vyzvednut a recyklován podle zákonů příslušné země, aby nedocházelo k zatěžování životního prostředí. Zbavujete-li se produktu, kontaktujte distributora nebo pobočku ve své zemi. Kontaktní adresy jsou uvedeny na následující webové stránce společnosti EIZO.
<http://www.eizoglobal.com>

Ringlussevõtu alane teave

Keskkonnakoormuse vähendamiseks tuleks kasutatud tooted kokku koguda ja võtta ringlusse vastavalt teie riigi seadustele. Kui kõrvaldate käesoleva toote, võtke palun ühendust turustaja või filiaaliga oma riigis. Kontaktisikud on toodud EIZO veebilehel järgmisel aadressil:
<http://www.eizoglobal.com>

Újrahasznosítási információ

Jelen terméket, amikor eldobjuk, az illető ország törvényei alapján kell összegyűjteni és újrahasznosítani, hogy csökkentsük a környezet terhelését. Amikor ezt a terméket eldobja, kérjük lépjen kapcsolatba egy országon belüli forgalmazóval vagy társvállalkozással.
A kapcsolat címei az EIZO alábbi weboldalán találhatók felsorolva:
<http://www.eizoglobal.com>

Podatki o recikliranju

Ob koncu uporabe odslužen izdelek izročite na zbirno mesto za recikliranje v skladu z okoljevarstveno zakonodajo vaše države. Prosimo, da se pri odstranjevanju izdelka obrnete na lokalnega distributerja ali podružnico.
Kontaktne naslovi so objavljeni na spodaj navedenih spletnih straneh EIZO:
<http://www.eizoglobal.com>

Informácie o recyklácii

Pri likvidácii musí byť tento výrobok recyklovaný v súlade s legislatívou vašej krajiny, aby sa znížilo zaťaženie životného prostredia. Keď sa chcete zbaviť tohto výrobku, kontaktujte prosím distribútora alebo pobočku vo vašej krajine.
Zoznam kontaktných adries je uvedený na nasledovnej webovej stránke firmy EIZO:
<http://www.eizoglobal.com>

Pārstrādes informācija

Utilizējot šo produktu, tā savākšana un pārstrāde veicama atbilstoši jūsu valsts likumdošanas prasībām attiecībā uz slodzes uz vidi samazināšanu. Lai veiktu šī produkta utilizāciju, sazinieties ar izplatītāju vai pārstāvniecību jūsu valstī.
Kontaktadrese ir norādītas zemāk minētajā EIZO tīmekļa vietnē.
<http://www.eizoglobal.com>

Informacja apie gražinamąjį perdirbimą

Šalinant (išmetant) šiuos gaminius juos reikia surinkti ir perdirbti gražinamuoju būdu pagal jūsų šalies teisės aktus, siekiant sumažinti aplinkos teršimą. Kai reikia išmesti šį gaminį, kreipkitės į jūsų šalyje veikiančią gaminių pardavimo atstovybę arba jos filiaalą.
Kontaktiniai adresatai nurodyti EIZO interneto svetainėje.
<http://www.eizoglobal.com>

Информация относно рециклиране

При изхвърлянето на този продукт се предлага събирането и рециклирането му съобразно законите на вашата страна за да се намали замърсяването на околната среда. Когато искате да се освободите от този продукт, моля свържете се с търговския му представител или със съответните органи отговарящи за това във вашата страна.

Данните за връзка с нас са описани на следния Интернет сайт на EIZO:
<http://www.eizoglobal.com>

Informație referitoare la reciclare

Acest produs, când debarasat, trebuie colectat și reciclat conform legislației țării respective ca să reducem sarcina mediului. Când se debarasează de acest produs, vă rugăm să contactați un distribuitor sau un afiliat al țării respective.

Adresele de contact le găsiți pe pagina de web al EIZO:
<http://www.eizoglobal.com>

معلومات عن إعادة التدوير

عند التخلص من هذا المنتج، من الضروري تجميعه وإعادة تدويره وفقاً للقوانين المتبعة في بلدك لتقليل العبء المسلط على البيئة. عندما تتخلص من هذا المنتج، يرجى الاتصال بموزع أو طرف متنسب إليه في بلدك. عناوين الاتصال مدرجة في موقع ايزو EIZO ادناه على شبكة الانترنت.

<http://www.eizoglobal.com>

Geri Dönüşüm Bilgisi

Bu ürünün, atılacağı zaman, ülkenizin çevre kirliliğinin azaltılması konusundaki mevzuatına göre toplanması ve yeniden değerlendirilmesi gerekmektedir. Ürünü atacağınız zaman lütfen ülkenizdeki bir distribütör veya ilgili kuruluşla temasa geçiniz.

İrtibat adresleri aşağıdaki EIZO web sitesinde verilmiştir.
<http://www.eizoglobal.com>

