

User's Manual

FlexScan® S1501-B

Color LCD Monitor

Important

Please read this User's Manual and the Setup Manual (separate volume) carefully to familiarize yourself with safe and effective usage.

- Please refer to the Setup Manual for basic information ranging from connection of the monitor to a PC to using the monitor.
- The latest User's Manual is available for download from our web site:
<http://www.eizo.com>

PRECAUTIONS

Notice for this monitor

CONTENTS

Chapter 1 Features and Overview

- 1-1 Features
- 1-2 Buttons and Indicators
- 1-3 Functions and Basic Operation

Chapter 2 Settings and Adjustments

- 2-1 Utility Disk
- 2-2 Screen Adjustment
- 2-3 Color Adjustment
- 2-4 Off Timer Settings
- 2-5 Power Indicator/EIZO Logo Display Settings
- 2-6 Locking Buttons
- 2-7 Disabling DDC/CI Communication
- 2-8 Setting Adjustment Menu Position
- 2-9 Viewing Information/Setting Language
- 2-10 Setting BrightRegulator
- 2-11 Resumption of Default Setting

Chapter 3 Connecting Cables

- 3-1 Connecting Two PCs to the Monitor

Chapter 4 Troubleshooting





Chapter 5 Reference

- 5-1 Attaching an Arm
- 5-2 Power Saving Mode
- 5-3 Specifications
- 5-4 Glossary
- 5-5 Preset Timing



SAFETY SYMBOLS

This manual uses the safety symbols below. They denote critical information. Please read them carefully.

	WARNING Failure to abide by the information in a WARNING may result in serious injury and can be life threatening.		CAUTION Failure to abide by the information in a CAUTION may result in moderate injury and/or property or product damage.
	Indicates a prohibited action.		
	Indicates a mandatory action that must be followed.		

Copyright© 2009-2013 EIZO Corporation All rights reserved.

No part of this manual may be reproduced, stored in a retrieval system, or transmitted, in any form or by any means, electronic, mechanical, or otherwise, without the prior written permission of EIZO Corporation.

EIZO Corporation is under no obligation to hold any submitted material or information confidential unless prior arrangements are made pursuant to EIZO Corporation's receipt of said information. Although every effort has been made to ensure that this manual provides up-to-date information, please note that EIZO monitor specifications are subject to change without notice.

VESA is a registered trademark or a trademark of the Video Electronics Standards Association in the United States and other countries. Windows, Windows Vista, Windows Media, SQL Server, and Xbox 360 are registered trademarks of Microsoft Corporation in the United States and other countries.

Apple, Mac, Macintosh, iMac, eMac, Mac OS, MacBook, PowerBook, ColorSync, QuickTime, and iBook are registered trademarks of Apple Inc.

EIZO, the EIZO Logo, ColorEdge, DuraVision, FlexScan, FORIS, RadiForce, RadiCS, RadiNET, Raptor, and ScreenManager are registered trademarks of EIZO Corporation in Japan and other countries.

All other company and product names are trademarks or registered trademarks of their respective owners.

<p>This product has been adjusted specifically for use in the region to which it was originally shipped. If operated outside this region, the product may not perform as stated in the specifications.</p>
--

PRECAUTIONS

IMPORTANT

- This product has been adjusted specifically for use in the region to which it was originally shipped. If the product is used outside the region, it may not operate as specified in the specifications.
- To ensure personal safety and proper maintenance, please read carefully this section and the caution statements on the monitor.

[Location of Caution Statement]

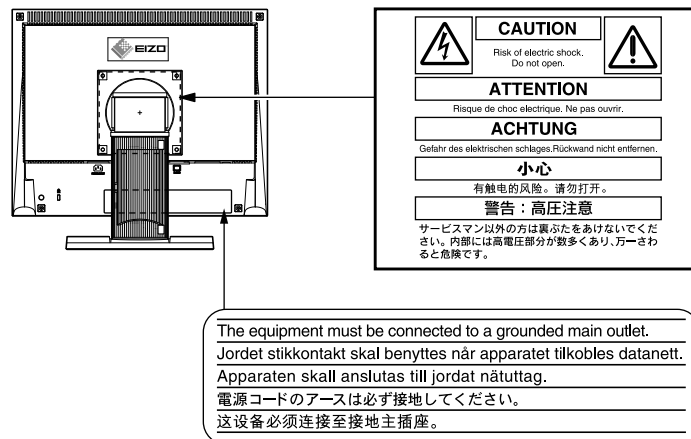

WARNING

If the unit begins to emit smoke, smells like something is burning, or makes strange noises, disconnect all power connections immediately and contact your dealer for advice.

Attempting to use a malfunctioning unit may result in fire, electric shock, or equipment damage.

Do not open the cabinet or modify the unit.

Opening the cabinet or modifying the unit may result in fire, electric shock, or burn.



Refer all servicing to qualified service personnel.

Do not attempt to service this product yourself as opening or removing covers may result in fire, electric shock, or equipment damage.

Keep small objects or liquids away from the unit.

Small objects accidentally falling through the ventilation slots into the cabinet or spillage into the cabinet may result in fire, electric shock, or equipment damage.

If an object or liquid falls/spills into the cabinet, unplug the unit immediately. Have the unit checked by a qualified service engineer before using it again.



WARNING

Place the unit at the strong and stable place.

A unit placed on an inadequate surface may fall and result in injury or equipment damage. If the unit falls, disconnect the power immediately and ask your dealer for advice. Do not continue using a damaged unit. Using a damaged unit may result in fire or electric shock.

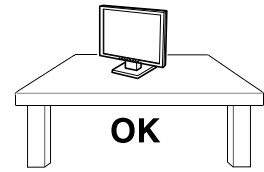

Use the unit in an appropriate location.

Not doing so may result in fire, electric shock, or equipment damage.

- Do not place outdoors.
- Do not place in the transportation system (ship, aircraft, trains, automobiles, etc.)
- Do not place in a dusty or humid environment.
- Do not place in a location where water is splashed on the screen (bathroom, kitchen, etc.).
- Do not place in a location where the steam comes directly on the screen.
- Do not place near heat generating devices or a humidifier.
- Do not place in a location where the product is subject to direct sunlight.
- Do not place in an inflammable gas environment.

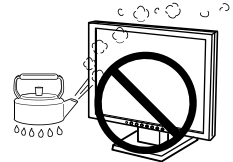

To avoid danger of suffocation, keep the plastic packing bags away from babies and children.

Use the enclosed power cord and connect to the standard power outlet of your country.

Be sure to remain within the rated voltage of the power cord.

Not doing so may result in fire or electric shock.

To disconnect the power cord, grasp the plug firmly and pull.

Tugging on the cord may damage and result in fire or electric shock.



The equipment must be connected to a grounded main outlet.

Failure to do so may result in fire or electric shock.



Use the correct voltage.

- The unit is designed for use with a specific voltage only. Connection to another voltage than specified in this User's Manual may cause fire, electric shock, or equipment damage.
- Do not overload your power circuit, as this may result in fire or electric shock.

Handle the power cord with care.

- Do not place the cord underneath the unit or other heavy objects.
- Do not pull on or tie the cord.

If the power cord becomes damaged, stop using it. Use of a damaged cord may result in fire or electric shock.

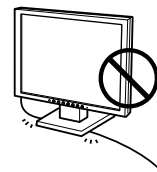

Never touch the plug and power cord if it begins to thunder.

Touching them may result in electric shock.

WARNING

When attaching an arm stand, please refer to the user's manual of the arm stand and install the unit securely.

Not doing so may cause the unit to become unattached, which may result in injury or equipment damage. When the unit is dropped, please ask your dealer for advice. Do not continue using a damaged unit. Using a damaged unit may result in fire or electric shock. When reattaching the tilt stand, please use the same screws and tighten them securely.

Do not touch a damaged LCD panel directly with bare hands.

The liquid crystal that may leak from the panel is poisonous if it enters the eyes or mouth. If any part of the skin or body comes in direct contact with the panel, please wash thoroughly. If some physical symptoms result, please consult your doctor.



Fluorescent backlight lamps contain mercury (the products that have LED backlight lamps contain no mercury), dispose according to local, state or federal laws.

CAUTION

Handle with care when carrying the unit.

Disconnect the power cord and cables when moving the unit. Moving the unit with the cord attached is dangerous. It may result in injury.

When handling the unit, grip the bottom of the unit firmly with both hands ensuring the panel faces outward before lifting.

Dropping the unit may result in injury or equipment damage.

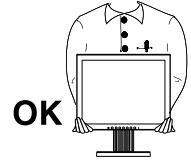

Do not block the ventilation slots on the cabinet.

- Do not place any objects on the ventilation slots.
- Do not install the unit in a closed space.
- Do not use the unit laid down or upside down.

Blocking the ventilation slots prevents proper airflow and may result in fire, electric shock, or equipment damage.

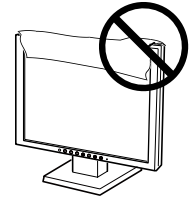

Do not touch the plug with wet hands.

Doing so may result in electrical shock.



Use an easily accessible power outlet.

This will ensure that you can disconnect the power quickly in case of a problem.

Periodically clean the area around the plug.

Dust, water, or oil on the plug may result in fire.

Unplug the unit before cleaning it.

Cleaning the unit while it is plugged into a power outlet may result in electric shock.

If you plan to leave the unit unused for an extended period, disconnect the power cord from the wall socket after turning off the power switch for the safety and the power conservation.

Notice for this monitor

This product is suited to general purposes like creating documents, viewing multimedia content.

This product has been adjusted specifically for use in the region to which it was originally shipped. If the product is used outside the region, it may not operate as specified in the specifications.

This product may not be covered by warranty for uses other than those described in this manual.

The specifications noted in this manual are only applicable when the following are used:

- Power cords provided with the product
 - Signal cables specified by us
-

Only use optional products manufactured or specified by us with this product.

As it takes about 30 minutes for the performance of electrical parts to stabilize, adjust the monitor 30 minutes or more after the monitor power has been turned on.

Monitors should be set to a lower brightness to reduce changes in luminosity caused by long-term use and maintain a stable display.

When the screen image is changed after displaying the same image for extended periods of time, an afterimage may appear. Use the screen saver or power save function to avoid displaying the same image for extended periods of time.

Periodic cleaning is recommended to keep the monitor looking new and to prolong its operation lifetime (refer to [“Cleaning”](#) on the next page).

The LCD panel is manufactured using high-precision technology. Although, missing pixels or lit pixels may appear on the LCD panel, this is not a malfunction. Percentage of effective dots: 99.9994% or higher.

The backlight of the LCD panel has a fixed lifetime. When the screen becomes dark or begins to flicker, please contact your dealer.

Do not press on the panel or edge of the frame strongly, as this may result in display malfunctions, such as interference patterns, etc. If pressure is continually applied to the panel, it may deteriorate or damage your panel. (If the pressure marks remain on the panel, leave the monitor with a black or white screen. The symptom may disappear.)

Do not scratch or press on the panel with any sharp objects, as this may result in damage to the panel. Do not attempt to brush with tissues as this may scratch the panel.

When the monitor is cold and brought into a room or the room temperature goes up quickly, dew condensation may occur on the interior and exterior surfaces of the monitor. In that case, do not turn the monitor on. Instead wait until the dew condensation disappears, otherwise it may cause some damage to the monitor.

Cleaning

Attention

- Chemicals such as alcohol and antiseptic solution may cause gloss variation, tarnishing, and fading of the cabinet or panel, and also quality deterioration of the image.
 - Never use any thinner, benzene, wax, and abrasive cleaner, which may damage the cabinet or panel.
-

Note

- The optional ScreenCleaner is recommended for cleaning the cabinet and panel surface.
-

If necessary, the stains on the cabinet and panel surface can be removed by moistening part of a soft cloth with water.

To use the monitor comfortably

- An excessively dark or bright screen may affect your eyes. Adjust the brightness of the monitor according to the environmental conditions.
- Staring at the monitor for a long time tires your eyes. Take a 10-minute rest every hour.

CONTENTS

Cover	1	Chapter 5 Reference	24
PRECAUTIONS	1	5-1 Attaching an Arm	24
Notice for this monitor	5	5-2 Power Saving Mode	25
Cleaning	6	5-3 Specifications	26
To use the monitor comfortably	6	5-4 Glossary	29
CONTENTS	7	5-5 Preset Timing	30
Chapter 1 Features and Overview	8		
1-1 Features	8		
1-2 Buttons and Indicators	8		
1-3 Functions and Basic Operation	9		
Chapter 2 Settings and Adjustments	11		
2-1 Utility Disk	11		
2-2 Screen Adjustment	12		
Digital Input	12		
Analog Input	12		
2-3 Color Adjustment	15		
Simple Adjustment [FineContrast Mode]	15		
Advanced Adjustments [Adjustment Menu]	16		
2-4 Off Timer Settings	17		
2-5 Power Indicator/EIZO Logo Display Settings	18		
2-6 Locking Buttons	18		
2-7 Disabling DDC/CI Communication	19		
2-8 Setting Adjustment Menu Position	19		
2-9 Viewing Information/Setting Language	19		
2-10 Setting BrightRegulator	20		
2-11 Resumption of Default Setting	20		
Chapter 3 Connecting Cables	21		
3-1 Connecting Two PCs to the Monitor	21		
Chapter 4 Troubleshooting	22		

Chapter 1 Features and Overview

Thank you very much for choosing an EIZO color LCD monitor.

1-1 Features

- Dual-input compliant (DVI-D and D-sub mini 15-pin connectors)
- DVI digital input (TMDS) compliant
- Horizontal scan frequency: Analog: 24.8 - 60 kHz
Digital: 31 - 49 kHz
- Vertical scan frequency: Analog: 55 - 75 Hz
Digital: 59 - 61 Hz (VGA text: 69 - 71 Hz)
- Resolution: 1024 dots × 768 lines
- Stereo speakers
- Smoothing (soft - sharp) function
- BrightRegulator function
- FineContrast mode to allow the best mode for screen display
- Self Adjust function

1-2 Buttons and Indicators

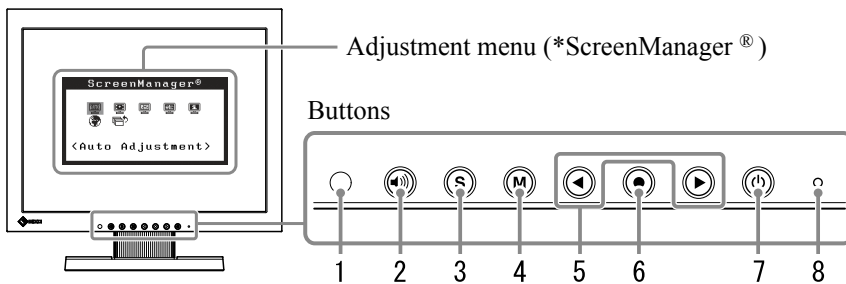

1. Sensor (BrightRegulator)
2. Volume control button
3. Input signal selection button
4. Mode button
5. Control buttons (Left, Right)
6. Enter button
7. Power button
8. Power indicator

Indicator status	Operation status
Blue	The screen is displayed
Orange	Power saving
Off	Power off

* ScreenManager® is an EIZO's nickname of the Adjustment menu.

Note

- The stand of the unit can be replaced with an arm or another stand. (Refer to “5-1 Attaching an Arm” on page 24.)

Note

- While the screen is displayed, the blue power indicator that is lighting blue can be turned off (see “To turn off the Power indicator while a screen is displayed [Power Indicator]” on page 18).
- For the power indicator status with “Off Timer” set, refer to “To set monitor power-off time [Off Timer]” on page 17.

1-3 Functions and Basic Operation

To adjust the screen and color

● Main menu (Refer to page 10 for operation)

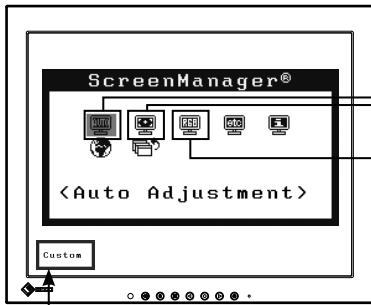

• The Adjustment menu and the FineContrast mode cannot be displayed at the same time.

Ⓜ FineContrast mode

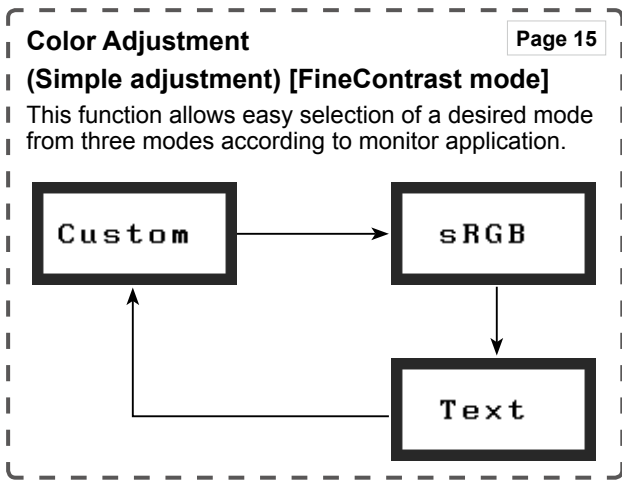

(for analog signal input only)

1 Screen Adjustment (Automatic Adjustment) Page 12

Auto Adjustment

- To adjust flickering and position [Screen]..... see [page 12](#)
- To adjust color gradation automatically [Range] see [page 14](#)

2 Screen Adjustment (Advanced Adjustment) Page 12

[Adjustment menu]

[At analog signal input] [At digital signal input]

- To eliminate vertical bars [Clock*] ... see [page 13](#)
- To remove flickering or blurring [Phase*]..... see [page 13](#)
- To correct screen position [Hor. Position*] see [page 13](#)
- [Ver. Position*] see [page 13](#)
- To modify blurred characters/lines [Smoothing] see [page 14](#)

* Items marked with * can be adjusted with analog input.

Brightness Adjustment
Press ◀ or ▶ to adjust brightness.

Volume Adjustment

1 Press 🔊.

2 Press ◀ or ▶ to adjust volume.

Color Adjustment (Advanced Adjustment) Page 16

Color (Custom)

- “Brightness,” “Contrast,” “Temperature,” “Gamma,” and “Gain” can be set for each mode (Custom/sRGB/Text). Settable functions vary with the display mode.

Resumption of Default Setting

- To reset color adjustment [Reset] ... see [page 20](#)

To make useful settings/adjustments

- Adjustment menu (Refer to below for operation)



Others

<Input Signal>

- Setting Input Signal Selection**
 - To set input signal selection [Input Signal] see [page 21](#)
- Off Timer Setting**
 - To set monitor power-off time [Off Timer] see [page 17](#)
- Setting Adjustment Menu Position**
 - To adjust the menu position [Menu Position] see [page 19](#)
- BrightRegulator setting**
 - To set automatic brightness adjustment [BrightRegulator] see [page 20](#)
- Power Indicator Setting**
 - To turn off the Power indicator while a screen is displayed [Power Indicator] see [page 18](#)
- Resumption of Default Setting**
 - To reset all settings [Reset] see [page 20](#)

Information Page 19

Information(1/3)

Input Analog
1024x768
fH: 48.3kHz
fV: 60.0Hz

- To check settings, usage time, etc. [Information]

Language Page 19

Language

English Deutsch
 Français Español
 Italiano Svenska
 简体中文 繁體中文
 日本語

- To set a language to be displayed [Language]

EIZO Logo Display Setting

- To display EIZO logo [EIZO Logo Appearing Function] see [page 18](#)

Locking Buttons

- To lock operation [Adjustment Lock] see [page 18](#)

Disabling DDC/CI Communication

- To disable DDC/CI communication see [page 19](#)

Connecting Cables

- Connecting Two PCs to the Monitor see [page 21](#)

Basic operation of Adjustment menu

[Displaying Adjustment menu and selecting function]

- Press ●. The main menu appears.
- Select a function with ◀ or ▶, and press ●. The sub menu appears.
- Select a function with ◀ or ▶, and press ●. The adjustment/setting menu appears.
- Adjust the selected item with ◀ or ▶, and press ●. The setting is saved.

[Exiting Adjustment menu]

- Choose <Return> from the sub menu and press ●.
- Choose <Exit> from the main menu and press ●.

Note

- The Adjustment menu can also be exited by pressing ● twice quickly.

Chapter 2 Settings and Adjustments

2-1 Utility Disk

An “EIZO LCD Utility Disk” (CD-ROM) is supplied with the monitor. The following table shows the disk contents and the overview of the application software programs.

- **Disk contents and software overview**

The disk includes software programs for adjustment, and User’s Manual. Refer to “Readme.txt” file on the disk for software startup procedures or file access procedures.

Item	Overview	For Windows	For Macintosh
A “Readme.txt” file		√	√
Screen adjustment pattern files	Used when adjusting the image of analog signal input manually.	√	√
User’s Manual of this monitor (PDF file)			

2-2 Screen Adjustment

Digital Input

When digital signals are input, images are displayed correctly based on the preset data of the monitor.

Analog Input

The monitor screen adjustment is used to suppress flickering of the screen or adjust screen position and screen size correctly according to the PC to be used. To use the monitor comfortably, adjust the screen when the monitor is set up for the first time or when the settings of the PC in use are updated.





The auto-adjustment function works in the following cases:

- When a signal is input into the monitor for the first time
- When a signal is input into the monitor for the first time after the resolution or refresh rate of input signals is changed

[Adjustment Procedure]

■ Automatic Adjustment

1 To adjust screen automatically [Screen]

- (1) Choose <Screen> from the <Auto Adjustment> menu, and press .
- (2) Select "Execute" with  or , and press .
- (3) Flickering, screen position, and screen size are corrected by the auto-adjustment function.

If satisfactory adjustment cannot be obtained with the auto-adjustment function, perform the adjustment following the procedure below. When the screen is displayed correctly, go to step 4 "Range Adjustment".

■ Advanced Adjustment

2 Prepare to use analog screen adjustment patterns.

Load the "EIZO LCD Utility Disk" to your PC, and then open the "Screen adjustment pattern files".

Attention

- Wait 30 minutes or more from monitor power on before starting adjustments.

Attention

- This function works correctly when an image is fully displayed over the display area. It does not work properly when an image is displayed only on a part of the screen (DOS prompt window, for example) or when a black background (wallpaper, etc.) is in use.
- This function does not work correctly with some graphics boards.
- "Auto in Progress" appears on the screen during auto adjustment.

Note

- For details and instructions on opening the "Screen adjustment pattern files", refer to the Readme.txt file.

3 Perform advanced adjustments for the following using the <Screen> menu of the Adjustment menu.

- **To eliminate vertical bars [Clock]**

- (1) Display Pattern 1 in full screen on the monitor using the “Screen adjustment pattern files”.

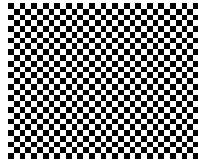

- (2) Choose <Clock> from the <Screen> menu, and press . The <Clock> menu appears.
- (3) Adjust the clock with or , and press . The adjustment is completed.

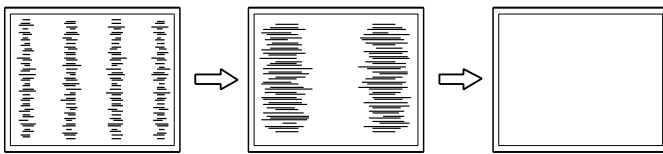

- **To remove flickering or blurring [Phase]**

- (1) Choose <Phase> from the <Screen> menu, and press . The <Phase> menu appears.
- (2) Adjust the phase with or , and press . The adjustment is completed.

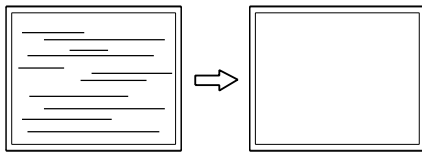

- **To correct screen position [Hor. Position], [Ver. Position]**

Since the number of pixels and the pixel positions are fixed on the LCD monitor, only one position is provided to display images correctly. The position adjustment is made to shift an image to the correct position.

- (1) Choose <Hor. Position> and or <Ver. Position> from the <Screen> menu, and press . The <Hor. Position> or <Ver. Position> menu appears.
- (2) Adjust the position with or to display the image properly in the display area of the monitor.

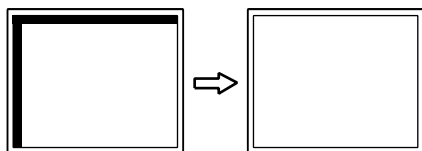

- (3) Close Pattern 1.

Note

- Press the control button slowly so as not to miss the adjustment point.
- When blurring, flickering or bars appear on the screen after adjustment, proceed to [Phase] to remove flickering or blurring.

Attention

- Flickering or blurring may not be eliminated depending on your PC or graphics board.

Note

- When vertical bars appear on the screen after adjustment, go back to “To eliminate vertical bars [Clock].” (Clock → Phase → Position)

4 Adjust the signal output range.

- **To adjust color gradation automatically [Range]**

Every color gradation (0 to 255) can be displayed by adjusting the signal output level.

- (1) Display Pattern 2 in full screen on the monitor using the “Screen adjustment pattern files”.

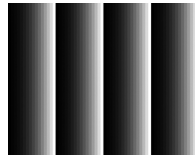

- (2) Choose <Range> from the <Auto Adjustment> menu, and press .
- (3) Select “Execute” with or , and press .
- (4) Color gradation is adjusted correctly by the auto-adjustment function.
The output range is adjusted automatically to display images with the maximum color gradation.
- (5) Close Pattern 2.

5 Change the smoothing setting.

- **To modify blurred characters/lines [Smoothing]**

When a low-resolution image is displayed, the characters or lines of the displayed image may be blurred.

- (1) Choose <Smoothing> from the <Screen> menu, and press .
The <Smoothing> menu appears.
- (2) Select a suitable level from 1 to 5 (where 1 = soft and 5 = sharp) with or , and press .
The smoothing adjustment is completed.

2-3 Color Adjustment

Simple Adjustment [FineContrast Mode]

This function allows you to select the best display mode for monitor brightness, etc.

- **FineContrast mode**

An appropriate display mode is selectable out of three modes.

Mode	Purpose
Custom	Available for making desired setting.
sRGB	Suitable for color matching with sRGB compatible peripherals.
Text	Suitable for displaying texts for word processing or spreadsheets.

FineContrast mode name
Example) Custom



- **To select FineContrast mode**

(1) Press **(M)**.

The FineContrast mode changes at every time pressing **(M)**.

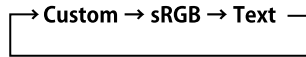

(2) Choose desired mode and press **(●)**.

The setting completes.

Note

- The Adjustment menu and the FineContrast mode cannot be displayed at the same time.

Advanced Adjustments [Adjustment Menu]

Independent setting and saving of color adjustment are available for each FineContrast mode.

• To select an appropriate mode for images

√ : Adjustment available — : Invalid for adjustment

Icon	Function	FineContrast mode		
		Custom	sRGB	Text
	Brightness	√	√	√
	Contrast	√	—	√
	Temperature	√	—	√
	Gamma	√	—	√
	Gain	√	—	—
	Reset	√	√	√

Menu	Description	Adjustment range
Brightness 	To adjust the full screen brightness as desired	0 to 100%
	Note <ul style="list-style-type: none"> You can also adjust the brightness by pressing ◀ or ▶ button while the adjustment menu is not displayed. Press ● after adjustment. The values shown in the “%” are available only as reference. 	
Contrast 	To adjust the contrast of the image	0 to 100%
	Note <ul style="list-style-type: none"> The values shown in the “%” are available only as reference. 	
Temperature 	To select a color temperature	4000K to 10000K in units of 500K (including 9300K).
	Note <ul style="list-style-type: none"> Setting the value to “Off” presents the natural color of the panel. The values shown in the Kelvin (K) are available only as reference. 	
Gamma 	To set a gamma value	1.8, 2.0, 2.2
Gain 	To adjust red, green, and blue to a desired color tone respectively	0 to 100% Adjust the respective brightness of red/green/blue to make a desired color tone. Display an image with white or gray background for adjustment.
	Note <ul style="list-style-type: none"> The values shown in the “%” are available only as reference. When using the <Gain> setting, the <Temperature> setting is set to “Off”. 	
Reset 	To reset the color settings of the selected FineContrast mode to the default settings	

• To set/adjust color

- Choose <Color> from the Adjustment menu, and press ●.
- Select a desired function from the <Color> menu, and press ●.
The selected function menu appears.
- Adjust the selected item with ◀ or ▶, and press ●.
The adjustment is completed.

Attention

- Perform [Range Adjustment] before starting color adjustment for analog input signals.
Refer to “To adjust color gradation automatically” on page 14.
- Wait 30 minutes or more from monitor power on before starting the color adjustment.
- Choose “Reset” in the <Color> menu to revert to the default settings (factory settings) of hue of the color mode selected.
- The same image may be seen in different colors on multiple monitors due to their monitor-specific characteristics. Make fine color adjustment visually when matching colors on multiple monitors.

Note

- The Adjustment menu and the FineContrast mode cannot be displayed at the same time.
- Adjustable functions vary depending on the type of FineContrast mode.

2-4 Off Timer Settings

• To set monitor power-off time [Off Timer]









This function allows the monitor to automatically turn off after a specified time has passed. This function serves to reduce afterimages caused when the monitor screen is left on for a long time period without use. Use this function when an image is displayed throughout the day.

[Off Timer System]

Timer	Monitor	Power Indicator
ON time (1H - 23H)	Operating	Blue
Last 15 min. in "ON time"	Advance Notice*	Flashing blue
"ON time" expired	Power Off	Off

* When  is pressed during the advance notice period, the monitor continues to operate for additional 90 minutes. Extension of operation time can be set without limitation.

[Procedure]

- (1) Choose <Others> from the Adjustment menu, and press .
- (2) Choose <Off Timer> from the <Others> menu, and press .
The <Off Timer> menu appears.
- (3) Select "Enable" with  or , and press .
- (4) Set a monitor ON time (1 to 23 hours) with  or , and press .
The Off Timer setting is completed.

[Resumption Procedure]

- Press .





Attention

- The Off Timer functions even in the power saving mode, but the advance notice is disabled. The monitor power is turned off without advance notice.

2-5 Power Indicator/EIZO Logo Display Settings

• To turn off the Power indicator while a screen is displayed [Power Indicator]



This function enables to turn off the Power indicator (blue) while a screen is displayed.

- (1) Choose <Others> from the Adjustment menu, and press .
- (2) Choose <Power Indicator> from the <Others> menu, and press .
The <Power Indicator> menu appears.
- (3) Select "Disable" with  or , and press .
The Power Indicator setting is completed.



• To display EIZO logo [EIZO Logo Appearing Function]

When this unit is turned on, the EIZO logo appears at the center of the screen. Selection to display or not to display the logo is available with this function.

[Procedure]

- (1) Press  to power off the unit.
- (2) Press  again while pressing .
The EIZO logo does not appear on the screen.







[Resetting]



- (1) Press  to power off the unit.
- (2) Press  again while pressing .
The logo appears again.

2-6 Locking Buttons



• To lock operation [Adjustment Lock]

This function locks the buttons to retain the status adjusted or set once.

Buttons that can be locked	<ul style="list-style-type: none"> •  (Enter button) Adjustments/settings using Adjustment menu
Buttons that cannot be locked	<ul style="list-style-type: none"> •  /  (Control buttons) •  (Volume control button) •  (Input Signal Selection button) •  (Mode button) •  (Power button)

- (1) Press  to turn off the unit.
- (2) Press  again while pressing .
The screen is displayed with the adjustment lock.

[Unlocking]

- (1) Press  to turn off the unit.
- (2) Press  again while pressing .
The screen is displayed with the adjustment lock released.

Note

- The Power indicator lights up at power on with the default setting.



Note

- The logo appears with the default setting.



2-7 Disabling DDC/CI Communication

• To disable DDC/CI communication



[Procedure]

- (1) Press  to turn off the unit.
- (2) Press  again while pressing **(M)**.
DDC/CI communication setting is disabled.

[Resetting]

- (1) Press  to turn off the unit.
- (2) Press  again while pressing **(M)**.
DDC/CI communication setting is enabled.





[Checking the setting status]

- (1) Select <Information> menu in the Adjustment menu and press .
The <Information> menu appears.
- (2) Pressing  continuously, the DDC/CI communication setting status is shown on the 2nd page of the information page.

2-8 Setting Adjustment Menu Position

• To adjust the menu position [Menu Position]

Adjust the menu position using the following procedure.

- (1) Choose <Others> from the Adjustment menu, and press .
- (2) Choose <Menu Position> from the <Others> menu, and press .
- (3) Select a menu position with  or , and press .



Note

- Five positions (center/ upper right/ lower right/ upper left/ lower left) can be selected.

2-9 Viewing Information/Setting Language

• To check settings, usage time, etc. [Information]

This function allows you to check settings, model name, serial number, and usage time of the monitor.





- (1) Choose <Information> from the Adjustment menu, and press .
- (2) Then, press  to check settings, etc.

• To set a language to be displayed [Language]

Select the Adjustment menu language.

Selectable languages

English/German/French/Spanish/Italian/Swedish/Simplified Chinese/
Traditional Chinese/Japanese

- (1) Choose <Language> menu from the Adjustment menu, and press .
- (2) Choose a language with  or , and press .





Note

- The usage time is not always “0” when you purchase the monitor due to factory inspection.

2-10 Setting BrightRegulator

• To set automatic brightness adjustment [BrightRegulator]





The sensor on the front side of the monitor detects the environmental brightness to adjust the screen brightness automatically and comfortably.

- (1) Choose <Others> from the Adjustment menu, and press .
- (2) Choose <BrightRegulator> from the <Others> menu, and press .
The BrightRegulator setting window appears.
- (3) Select “Enable” or “Disable” with  or , and press .
The BrightRegulator setting is completed.

2-11 Resumption of Default Setting





• To reset color adjustment [Reset]

The hue in the color mode currently set will revert to the default settings (factory settings).

- (1) Choose <Color> from the Adjustment menu, and press .
- (2) Choose <Reset> from the <Color> menu and press .
The <Reset> menu appears.
- (3) Select <Reset> with  or , and press .
The reset operation is completed.

• To reset all settings [Reset]

Reset all adjustments/settings to the factory default settings.

- (1) Choose <Others> from the Adjustment menu, and press .
- (2) Choose <Reset> from the <Others> menu, and press .
The <Reset> menu appears.
- (3) Select <Reset> with  or , and press .
The reset operation is completed.

Note

- Be careful not to block the sensor on the lower side of the monitor when using the BrightRegulator function.

Note

- For default settings, refer to “[Main default settings \(factory settings\)](#)” on [page 27](#).

Chapter 3 Connecting Cables

3-1 Connecting Two PCs to the Monitor

Two PCs can be connected to the monitor through the DVI-D and the D-Sub mini 15 pin connector on the back of the monitor.

Connection examples

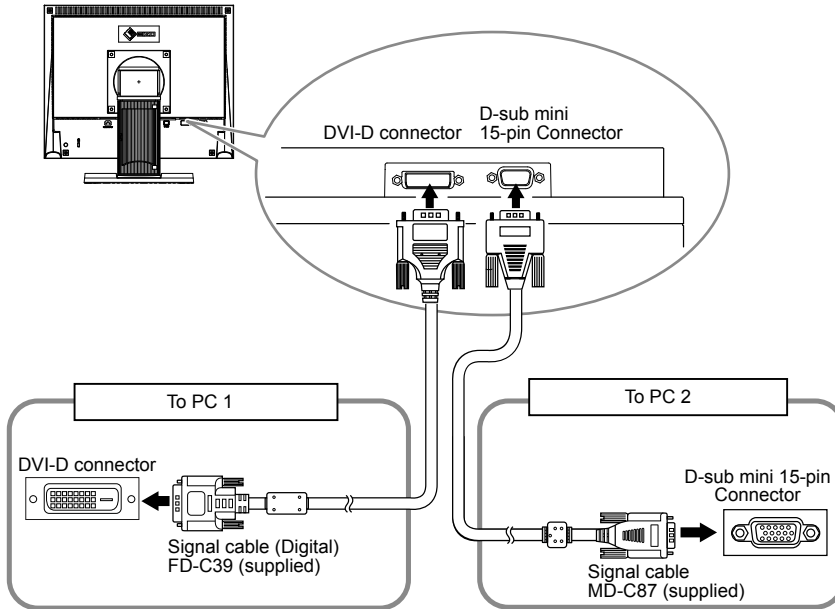

Selecting input signal

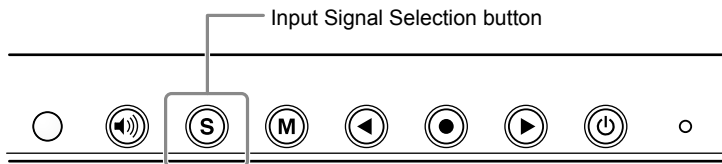

Switch the input signal with **(S)**. Input signal switches each time **(S)** is pressed. When the signal is switched, the active signal type (Analog or Digital) appears at the top right corner of the screen for three seconds.

• To set input signal selection [Input Signal]

Setting	Function
Auto	When PC displayed on the monitor is turned off or enters the power-saving mode, the monitor automatically displays signals of another PC.
Manual	The monitor does not detect the PC's signals automatically. Select an input signal with (S) .

[Procedure]

- (1) Choose <Others> from the Adjustment menu, and press **(●)**.
- (2) Choose <Input Signal> from the <Others> menu, and press **(●)**.
The <Input Signal> menu appears.
- (3) Select "Auto" or "Manual" with **(◀)** or **(▶)**, and press **(●)**.
The Input Priority setting is completed.







Note

- Power-saving function
When <Auto> is selected for <Input Signal>, the monitor's power-saving function works only when the two PCs are in the power-saving mode.

Chapter 4 Troubleshooting

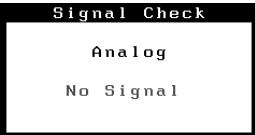
If a problem still remains after applying the suggested remedies, contact your local dealer.

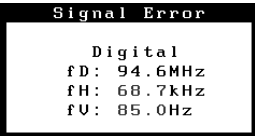
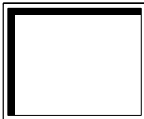
- No-picture problems → See No.1 - No.2.
- Imaging problems → See No.3 - No.11.
- Other problems → See No.12 - No.14.

Problems	Possible cause and remedy
<p>1. No picture</p> <ul style="list-style-type: none"> • Power indicator does not light. • Power indicator is lighting blue. • Power indicator is lighting orange. 	<ul style="list-style-type: none"> • Check whether the power cord is connected correctly. • Press . • Set each RGB adjusting value in <Gain> to higher level.(see page 16) • Switch the input signal with . • Operate the mouse or keyboard. • Turn on the PC.
<p>2. The message below appears.</p> <ul style="list-style-type: none"> • This message appears when no signal is input. 	<p>This message appears when the signal is not input correctly even when the monitor functions properly.</p> <ul style="list-style-type: none"> • The message shown left may appear, because some PCs do not output the signal soon after power-on. • Check whether the PC is turned on. • Check whether the signal cable is connected properly. • Switch the input signal with .
<ul style="list-style-type: none"> • The message below shows that the input signal is out of the specified frequency range. (Such signal frequency is displayed in red.) Example: 	<ul style="list-style-type: none"> • Select an appropriate display mode using the graphics board's utility software. Refer to the manual of the graphics board for details.
<p>3. Display position is incorrect.</p> 	<ul style="list-style-type: none"> • Adjust image position so that it is displayed properly within the display area using the <Hor.Position> and <Ver.Position> adjustment. • If the problem persists, use the graphics board's utility software if available to change the display position.
<p>4. Vertical bars appear on the screen or a part of the image is flickering.</p> 	<ul style="list-style-type: none"> • Adjust using <Clock>.
<p>5. Whole screen is flickering or blurring.</p> 	<ul style="list-style-type: none"> • Adjust using <Phase>.
<p>6. Characters are blurred.</p>	<ul style="list-style-type: none"> • Adjust using <Smoothing>.
<p>7. The screen is too bright or too dark.</p>	<ul style="list-style-type: none"> • Adjust <Brightness>. (The LCD monitor backlight has a fixed life span. When the screen becomes dark or begins to flicker, contact your local dealer.)

Problems	Possible cause and remedy
8. Afterimages appear.	<ul style="list-style-type: none"> • Use a screen saver or off timer function for a long-time image display. • Afterimages are particular to LCD monitors. Avoid displaying the same image for a long time.
9. Green/red/blue/white dots or defective dots remain on the screen.	<ul style="list-style-type: none"> • This is due to LCD panel characteristics and is not a failure.
10. Interference patterns or pressure marks remain on the screen.	<ul style="list-style-type: none"> • Leave the monitor with a white or black screen. The symptom may disappear.
11. The display image is appeared in lengthwise.	<ul style="list-style-type: none"> • Check whether the kind of cables connected with the monitor and the PC. (Connect the monitor and cables correctly by referring to “Connecting Cables” in Setup Manual (page 3).)
12. The Main menu of Adjustment menu does not start.	<ul style="list-style-type: none"> • Check for Adjustment Lock function. • Check whether the FineContrast menu is running. (Refer to “1-3 Functions and Basic Operation” on page 9.)
13. The auto-adjustment function does not work correctly.	<ul style="list-style-type: none"> • This function does not work when digital signal is input. • This function works correctly when an image is fully displayed over the display area. <p>It does not work properly when an image is displayed only on a part of the screen (DOS prompt window, for example) or when a black background (wallpaper, etc.) is in use.</p> <p>This function does not work correctly with some graphics boards.</p>
14. No audio output	<ul style="list-style-type: none"> • Check whether volume is set to “0”. • Check the settings of the PC and the audio playback software.

Chapter 5 Reference

5-1 Attaching an Arm

The stand can be removed and replaced with an arm (or another stand) to be attached to the monitor. Use an arm or stand of EIZO option.

[Attaching]

1 Lay the LCD monitor on a soft cloth spread over on a stable surface with the panel surface facing down.

2 Remove the stand. (Prepare a screwdriver.)

Unscrew the four screws securing the unit and the stand with the screwdriver.

3 Attach the monitor to the arm or stand.

Secure the monitor to the arm or stand using the screws specified in the user's manual of the arm or stand.

- Clearance between the screw holes when attach an arm or stand:
In case of 75mm × 75mm

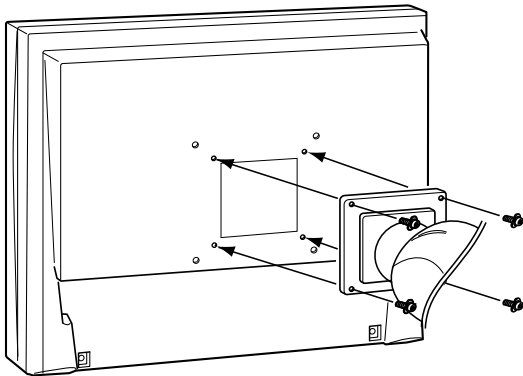

- Clearance between the screw holes when attach an arm or stand:
In case of 100mm × 100mm

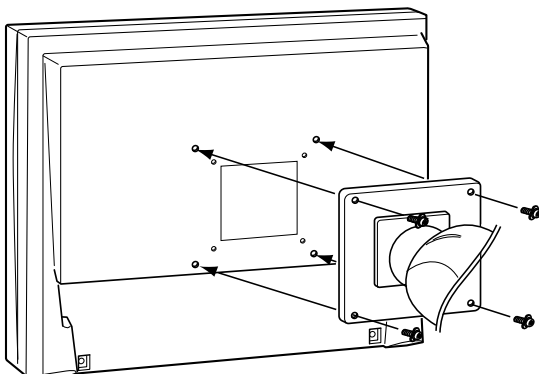

Attention

- When attaching an arm or stand, follow the instructions of their user's manual.
- When using another manufacturer's arm or stand, confirm the following in advance and select one conforming to the VESA standard. Use M4 × 12 mm screws supplied with the monitor.
 - Clearance between the screw holes:
75 mm × 75 mm or
100 mm × 100 mm
 - Thickness of plate: 2.6 mm
 - Strong enough to support weight of the monitor unit (except the stand) and attachments such as cables.
- When using an arm or stand, attach it to meet the following tilt angles of the monitor.
 - Up 60 degrees, down 45 degrees (horizontal display)
 - Up 45 degrees, down 45 degrees (vertical display, 90 degrees clockwise)
- Connect the cables after attaching an arm.

5-2 Power Saving Mode

■ Analog input

This monitor complies with the VESA DPMS standard.

[Power Saving System]

PC		Monitor	Power Indicator
Operating		Operating	Blue
Power saving	STAND-BY SUSPENDED OFF	Power saving	Orange

[Resumption Procedure]

- Operate the mouse or keyboard to resume the normal screen.

■ Digital input

This monitor complies with the DVI DMPM standard.

[Power Saving System]

The monitor enters the power saving mode in five seconds in connection with the PC setting.

PC	Monitor	Power Indicator
Operating	Operating	Blue
Power saving	Power saving	Orange

[Resumption Procedure]

- Operate the mouse or keyboard to resume the normal screen.

Attention

- Unplugging the power cord completely shuts off power supply to the monitor.
- Power consumption changes even when a sound input signal is detected.

5-3 Specifications

LCD Panel		15-inch (38 cm) TFT color LCD with anti-glare hard coating Viewing angle: Vertical 130°, Horizontal 160° (CR: 10 or more)
Dot Pitch		0.297 mm
Horizontal Scan Frequency		Analog: 24.8 - 60 kHz Digital: 31 - 49 kHz
Vertical Scan Frequency		Analog: 55 - 75 Hz (Non-interlace) Digital: 59 - 61 Hz, (VGA Text: 69 - 71 Hz) (Non-interlace)
Resolution		1024 dots × 768 lines
Max. Dot Clock		Analog: 80 MHz Digital: 65 MHz
Max. Display Colors		Approx. 16.19 million colors
Display Area (H × V)		304.1 mm × 228.1 mm
Power Supply		100 - 120 VAC ±10% 50/60 Hz, 0.5 A 200 - 240 VAC ±10% 50/60 Hz, 0.3 A
Power Consumption	Screen Display On	25 W (when stereo mini jack is not connected) 21 W (when stereo mini jack is connected)
	Power saving mode	1 W or less (for single signal input, and stereo mini jack is not connected)
	Power switch Off	1 W or less
Input Signal Connectors		DVI-D connector, D-sub mini 15-pin connector
Analog Input Signal (Sync)		H/V Separate, TTL, Positive/Negative
Analog Input Signal (Video)		0.7 Vp-p/75 Ω Positive
Digital Signal Transmission System		TMDS (Single Link)
Video Signal Memory		Analog Signal: 20 (preset: 15)
Audio output		Speaker output: 0.5 W + 0.5 W (8 Ω, THD: 10% or less) Headphone output: 2mW + 2mW
Line input		Input impedance 47 kΩ (typ.) Input level: 1.0 Vrms (Max.)
Plug & Play		VESA DDC 2B/EDID structure 1.3
Dimensions (Main unit)		346 mm (W) × 325 mm (H) × 175 mm (D) (13.6" (W) × 12.8" (H) × 6.9" (D))
Dimensions (without stand)		346 mm (W) × 280 mm (H) × 69 mm (D) (13.6" (W) × 11.0" (H) × 2.7" (D))
Weight (Main unit)		Approx. 5.3 kg (11.7 lbs)
Weight (without stand)		Approx. 3.7 kg (8.2 lbs)
Environmental Conditions	Temperature	Operating temperature: 0 °C - 35 °C Storage temperature: -20 °C - 60 °C
	Humidity	Operating humidity: 20% - 80% R.H. (no condensation) Storage humidity: 10% - 80% R.H. (no condensation)
	Pressure	Operating: 700 to 1,060 hPa Storage: 200 to 1,060 hPa

Main default settings (factory settings)

BrightRegulator	Disable
Smoothing	3
FineContrast Mode	Custom
Input Signal	Auto
Off Timer	Disable
Language	English

Outside Dimensions

unit : mm (inch)

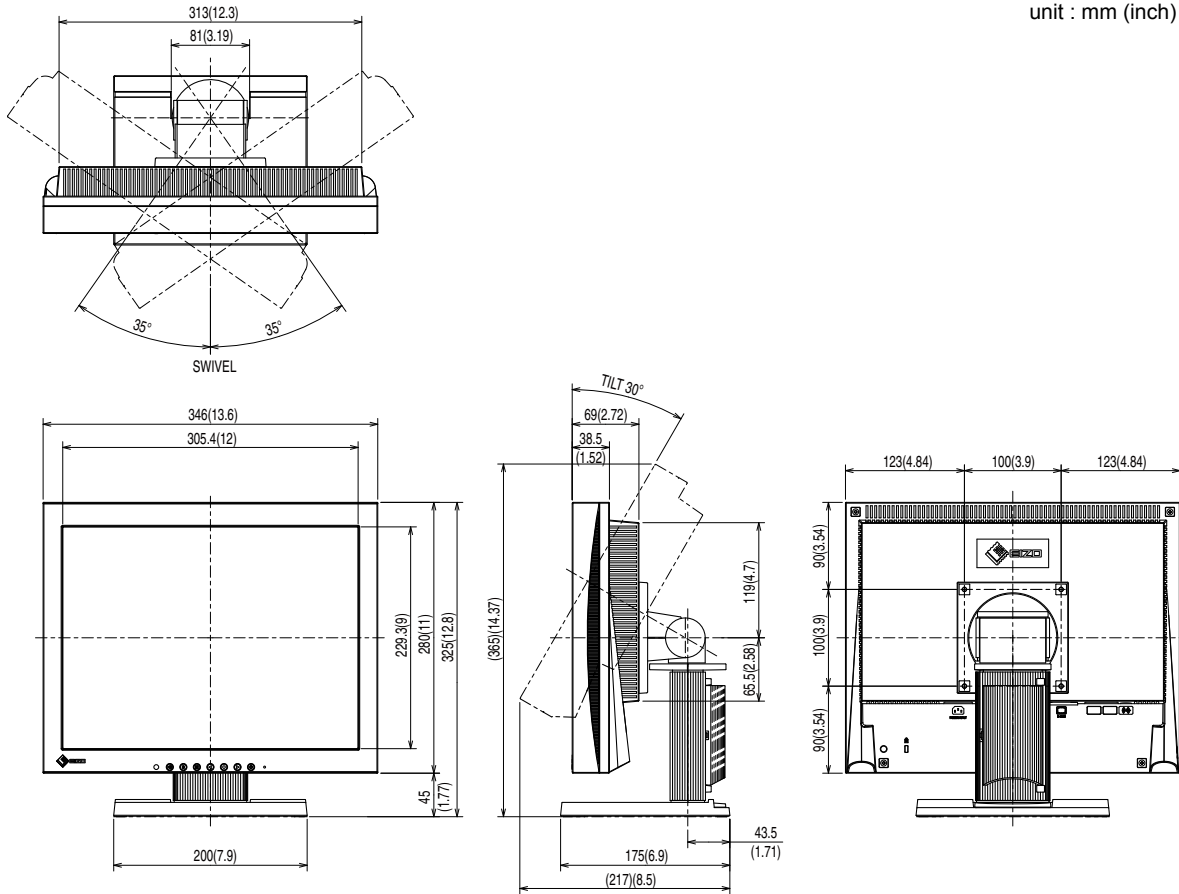

Connector Pin Assignment

- DVI-D connector

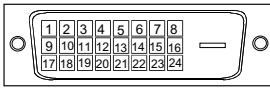

Pin No.	Signal	Pin No.	Signal	Pin No.	Signal
1	T.M.D.S. Data 2-	9	T.M.D.S. Data1-	17	T.M.D.S. Data 0-
2	T.M.D.S. Data 2+	10	T.M.D.S. Data1+	18	T.M.D.S. Data 0+
3	T.M.D.S. Data2/4 Shield	11	T.M.D.S. Data1/3 Shield	19	T.M.D.S. Data 0/5 Shield
4	NC*	12	NC*	20	NC*
5	NC*	13	NC*	21	NC*
6	DDC Clock (SCL)	14	+5V Power	22	T.M.D.S. Clock shield
7	DDC Data (SDA)	15	Ground (return for +5V, Hsync, and Vsync)	23	T.M.D.S. Clock+
8	NC*	16	Hot Plug Detect	24	T.M.D.S. Clock-

(NC*: No Connection)

- D-sub mini 15-pin connector

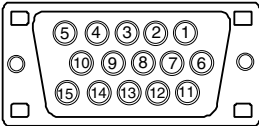

Pin No.	Signal	Pin No.	Signal	Pin No.	Signal
1	Red video	6	Red video ground	11	NC*
2	Green video	7	Green video ground	12	Data (SDA)
3	Blue video	8	Blue video ground	13	H. Sync
4	NC*	9	NC*	14	V. Sync
5	Ground	10	Ground	15	Clock (SCL)

(NC*: No Connection)

Option List

Cleaning Kit	EIZO ScreenCleaner
--------------	--------------------

5-4 Glossary

Clock

The analog input monitor needs to reproduce a clock of the same frequency as the dot clock of the graphics system in use, when the analog input signal is converted to a digital signal for image display.

This is called clock adjustment. If the clock pulse is not set correctly, some vertical bars appear on the screen.

DDC/CI (Display Data Channel/Command Interface)

VESA provides the standardization for the interactive communication of the setting information, etc. between a PC and the monitor.

DVI (Digital Visual Interface)

DVI is a digital interface standard. DVI allows direct transmission of the PC's digital data without loss.

This adopts the TMDS transmission system and DVI connectors. There are two types of DVI connectors. One is a DVI-D connector for digital signal input only. The other is a DVI-I connector for both digital and analog signal inputs.

DVI DMPM (DVI Digital Monitor Power Management)

DVI DMPM is a digital interface power-saving function. The "Monitor ON (operating mode)" and "Active Off (power-saving mode)" are indispensable for DVI DMPM as the monitor's power mode.

Gain

This is used to adjust each color parameter for red, green and blue. An LCD monitor displays the color by the light passing through the panel color filter. Red, green and blue are the three primary colors. All the colors on the screen are displayed by combining these three colors. The color tone can be changed by adjusting the light intensity (volume) passing through each color's filter.

Gamma

Generally, the monitor brightness varies nonlinearly with the input signal level, which is called "Gamma Characteristic". A small gamma value produces a low-contrast image, while a large gamma value produces a high-contrast image.

Phase

Phase means the sampling timing to convert the analog input signal to a digital signal. Phase adjustment is made to adjust the timing. It is recommended that phase adjustment be made after the clock is adjusted correctly.

Range Adjustment

Range adjustment controls the signal output levels to display every color gradation. It is recommended that range adjustment be made before color adjustment.

Resolution

The LCD panel consists of numerous pixels of specified size, which are illuminated to form images. The display panel of this monitor consists of 1024 horizontal pixels and 768 vertical pixels. At a resolution of 1024 × 768, images are displayed as a full screen (1:1).

sRGB (Standard RGB)

International standard for "color reproduction and color space" among peripheral devices (such as monitors, printers, digital cameras, scanners). sRGB allows Internet users to closely match colors as a simple color matching means for the Internet use.

Temperature

Color temperature is a method to measure the white color tone, generally indicated in degrees Kelvin. The screen becomes reddish at a low temperature, and bluish at a high temperature, like the flame temperature.

5000K: Slightly reddish white

6500K: Warm white like paper white

9300K: Slightly bluish white

TMDS (Transition Minimized Differential Signaling)

A signal transmission system for digital interface.

VESA DPMS (Video Electronics Standards Association - Display Power Management Signaling)

VESA provides the standardization of signals from PC (graphics board) for power saving of PC monitors. DPMS defines the signal status between PC and monitor.

5-5 Preset Timing

The following table shows factory preset video timing (for analog signal only).

Mode	Dot clock		Frequency		Polarity
			Horizontal: kHz	Vertical: Hz	
VGA 640×480@60Hz	25.2 MHz	Horizontal	31.47	Negative	
		Vertical	59.94	Negative	
VGA TEXT 720×400@70Hz	28.3 MHz	Horizontal	31.47	Negative	
		Vertical	70.09	Positive	
PC-9801 640×400@56Hz	21.1 MHz	Horizontal	24.83	Negative	
		Vertical	56.42	Negative	
PC-9821 640×400@70Hz	25.2 MHz	Horizontal	31.48	Negative	
		Vertical	70.10	Negative	
Macintosh 640×480@67Hz	30.2 MHz	Horizontal	35.00	Negative	
		Vertical	66.67	Negative	
Macintosh 832×624@75Hz	57.3 MHz	Horizontal	49.72	Negative	
		Vertical	74.55	Negative	
VESA 640×480@72Hz	31.5 MHz	Horizontal	37.86	Negative	
		Vertical	72.81	Negative	
VESA 640×480@75Hz	31.5 MHz	Horizontal	37.50	Negative	
		Vertical	75.00	Negative	
VESA 800×600@56Hz	36.0 MHz	Horizontal	35.16	Positive	
		Vertical	56.25	Positive	
VESA 800×600@60Hz	40.0 MHz	Horizontal	37.88	Positive	
		Vertical	60.32	Positive	
VESA 800×600@72Hz	50.0 MHz	Horizontal	48.08	Positive	
		Vertical	72.19	Positive	
VESA 800×600@75Hz	49.5 MHz	Horizontal	46.88	Positive	
		Vertical	75.00	Positive	
VESA 1024×768@60Hz	65.0 MHz	Horizontal	48.36	Negative	
		Vertical	60.00	Negative	
VESA 1024×768@70Hz	75.0 MHz	Horizontal	56.48	Negative	
		Vertical	70.07	Negative	
VESA 1024×768@75Hz	78.8 MHz	Horizontal	60.02	Positive	
		Vertical	75.03	Positive	

Attention

- Display position may be deviated depending on the PC connected, which may require screen adjustment using Adjustment menu.
- If a signal other than those listed in the table is input, adjust the screen using the Adjustment menu. However, screen display may still be incorrect even after the adjustment.
- When interlace signals are used, the screen cannot be displayed correctly even after screen adjustment using the Adjustment menu.

For U.S.A. , Canada, etc. (rated 100-120 Vac) Only

FCC Declaration of Conformity

We, the Responsible Party

EIZO Inc.

5710 Warland Drive, Cypress, CA 90630

Phone: (562) 431-5011

declare that the product

Trade name: EIZO

Model: FlexScan S1501-B

is in conformity with Part 15 of the FCC Rules. Operation of this product is subject to the following two conditions: (1) this device may not cause harmful interference, and (2) this device must accept any interference received, including interference that may cause undesired operation.

This equipment has been tested and found to comply with the limits for a Class B digital device, pursuant to Part 15 of the FCC Rules. These limits are designed to provide reasonable protection against harmful interference in a residential installation. This equipment generates, uses, and can radiate radio frequency energy and, if not installed and used in accordance with the instructions, may cause harmful interference to radio communications. However, there is no guarantee that interference will not occur in a particular installation. If this equipment does cause harmful interference to radio or television reception, which can be determined by turning the equipment off and on, the user is encouraged to try to correct the interference by one or more of the following measures.

- * Reorient or relocate the receiving antenna.
- * Increase the separation between the equipment and receiver.
- * Connect the equipment into an outlet on a circuit different from that to which the receiver is connected.
- * Consult the dealer or an experienced radio/TV technician for help.

Changes or modifications not expressly approved by the party responsible for compliance could void the user's authority to operate the equipment.

Note

Use the attached specified cable below or EIZO signal cable with this monitor so as to keep interference within the limits of a Class B digital device.

- AC Cord
- Shielded Signal Cable (enclosed)

Canadian Notice

This Class B digital apparatus complies with Canadian ICES-003.

Cet appareil numérique de la classe B est conforme à la norme NMB-003 du Canada.

Hinweise zur Auswahl des richtigen Schwenkarms für Ihren Monitor

Dieser Monitor ist für Bildschirmarbeitsplätze vorgesehen. Wenn nicht der zum Standardzubehör gehörige Schwenkarm verwendet wird, muss statt dessen ein geeigneter anderer Schwenkarm installiert werden. Bei der Auswahl des Schwenkarms sind die nachstehenden Hinweise zu berücksichtigen:

Der Standfuß muß den nachfolgenden Anforderungen entsprechen:

- a) Der Standfuß muß eine ausreichende mechanische Stabilität zur Aufnahme des Gewichtes vom Bildschirmgerät und des spezifizierten Zubehörs besitzen. Das Gewicht des Bildschirmgerätes und des Zubehörs sind in der zugehörigen Bedienungsanleitung angegeben.
- b) Die Befestigung des Standfusses muß derart erfolgen, daß die oberste Zeile der Bildschirmanzeige nicht höher als die Augenhöhe eines Benutzers in sitzender Position ist.
- c) Im Fall eines stehenden Benutzers muß die Befestigung des Bildschirmgerätes derart erfolgen, daß die Höhe der Bildschirmmitte über dem Boden zwischen 135 – 150 cm beträgt.
- d) Der Standfuß muß die Möglichkeit zur Neigung des Bildschirmgerätes besitzen (max. vorwärts: 5°, min. nach hinten \geq 5°).
- e) Der Standfuß muß die Möglichkeit zur Drehung des Bildschirmgerätes besitzen (max. $\pm 180^\circ$). Der maximale Kraftaufwand dafür muß weniger als 100 N betragen.
- f) Der Standfuß muß in der Stellung verharren, in die er manuell bewegt wurde.
- g) Der Glanzgrad des Standfusses muß weniger als 20 Glanzeinheiten betragen (seidenmatt).
- h) Der Standfuß mit Bildschirmgerät muß bei einer Neigung von bis zu 10° aus der normalen aufrechten Position kippstabil sein.

Hinweis zur Ergonomie :

Dieser Monitor erfüllt die Anforderungen an die Ergonomie nach EK1-ITB2000 mit dem Videosignal, 1024 × 768 Digital Eingang und mindestens 60,0 Hz Bildwiederholfrequenz, non interlaced. Weiterhin wird aus ergonomischen Gründen empfohlen, die Grundfarbe Blau nicht auf dunklem Untergrund zu verwenden (schlechte Erkennbarkeit, Augenbelastung bei zu geringem Zeichenkontrast.)

Übermäßiger Schalldruck von Ohrhörern bzw. Kopfhörern kann einen Hörverlust bewirken.

Eine Einstellung des Equalizers auf Maximalwerte erhöht die Ausgangsspannung am Ohrhörer- bzw. Kopfhörerausgang und damit auch den Schalldruckpegel.

„Maschinenlärminformations-Verordnung 3. GPSGV:

Der höchste Schalldruckpegel beträgt 70 dB(A) oder weniger gemäss EN ISO 7779“

[Begrenzung des maximalen Schalldruckpegels am Ohr]
Bildschirmgeräte: Größte Ausgangsspannung 150 mV

