

User's Manual

DuraVision® FDS1901

Color LCD Monitor

English

Deutsch

Français

中文

Important

Please read this User's Manual carefully to familiarize yourself with safe and effective usage. Please retain this manual for future reference.

Wichtig

Lesen Sie die dieses Benutzerhandbuch aufmerksam durch, um sich mit der sicheren und effizienten Bedienung vertraut zu machen. Bewahren Sie dieses Handbuch zum späteren Nachschlagen auf.

Important

Veillez lire attentivement ce Manuel d'utilisation afin de vous familiariser avec ce produit et de l'utiliser efficacement et en toute sécurité. Veuillez conserver ce manuel pour référence ultérieure.

重要事项

请仔细阅读用户手册，掌握如何安全、有效地使用本产品。请保留本手册，以备日后参考。



For U.S.A, Canada, etc. (rated 100-120 Vac) Only

This equipment has been tested and found to comply with the limits for a Class A digital device, pursuant to Part 15 of the FCC Rules. These limits are designed to provide reasonable protection against harmful interference when the equipment is operated in a commercial environment. This equipment generates, uses, and can radiate radio frequency energy and if not installed and used in accordance with the instruction manual, may cause harmful interference to radio communications. Operation of this equipment in a residential area is likely to cause harmful interference in which case the user will be required to correct the interference at his own expense.

Changes or modifications not expressly approved by the party responsible for compliance could void the user's authority to operate the equipment.

Note

Use the attached specified cable below or EIZO signal cable with this monitor so as to keep interference within the limits of a Class A digital device.

- AC Cord

Canadian Notice

This Class A digital apparatus complies with Canadian ICES-003.

Cet appareil numérique de la classe A est conforme à la norme NMB-003 du Canada.

For Europe, etc. (rated 200-240 Vac) Only

Warning

This is a Class A product. In a domestic environment this product may cause radio interference in which case the user may be required to take adequate measures.

Warnung

Bei dem Gerät handelt es sich um ein Klasse-A-Produkt. Bei Betrieb des Geräts in Wohnumgebungen ist gegebenenfalls durch entsprechende Maßnahmen dafür zu sorgen, dass eine Störung des Radio- und Fernsehempfangs vermieden wird.

Avertissement

Cet appareil est de classe A. Il est susceptible de créer des interférences radio dans un environnement domestique, dans ce cas l'utilisateur devra prendre les mesures appropriées.

User's Manual

DuraVision® FDS1901







Color LCD Monitor

SAFETY SYMBOLS

This manual and this product use the safety symbols below. They denote critical information. Please read them carefully.

 WARNING
Failure to abide by the information in a WARNING may result in serious injury and can be life threatening.

 CAUTION
Failure to abide by the information in a CAUTION may result in moderate injury and/or property or product damage.

	Indicates an attention to be required. For example, the symbol  illustrates the hazard type such as “the risk of electric shock”.
	Indicates a prohibited action. For example, the symbol  illustrates a particular prohibited action such as “Do not disassemble”.
	Indicates a mandatory action that must be followed. For example, the symbol  illustrates the notification of general prohibition such as “Grounding the unit”.

Using the special functions, such as screen size change (ex. changing the horizontal and vertical ratio of images input) for commercial purposes or for the purpose of showing in public may violate copyright laws.

<For USA-California Only>
 CR Coin Lithium Battery contains Perchlorate Material - special handling may apply.
 See www.dtsc.ca.gov/hazardouswaste/perchlorate.

This product has been adjusted specifically for use in the region to which it was originally shipped. If operated outside this region, the product may not perform as stated in the specifications.

No part of this manual may be reproduced, stored in a retrieval system, or transmitted, in any form or by any means, electronic, mechanical, or otherwise, without the prior written permission of EIZO Corporation. EIZO Corporation is under no obligation to hold any submitted material or information confidential unless prior arrangements are made pursuant to EIZO Corporation’s receipt of said information. Although every effort has been made to ensure that this manual provides up-to-date information, please note that EIZO monitor specifications are subject to change without notice.

Apple, ColorSync, eMac, iBook, iMac, iPad, Mac, MacBook, Macintosh, Mac OS, PowerBook, and QuickTime are registered trademarks of Apple Inc.
 Windows, Windows Media, Windows Vista, SQL Server, and Xbox 360 are registered trademarks of Microsoft Corporation in the United States and other countries.
 VESA is a registered trademark of Video Electronics Standards Association.
 NEC is a registered trademark of NEC Corporation.
 PC-9801 and PC-9821 are trademarks of NEC Corporation.
 EIZO, the EIZO Logo, ColorEdge, DuraVision, FlexScan, FORIS, RadiCS, RadiForce, RadiNET, Raptor, and ScreenManager are registered trademarks of EIZO Corporation in Japan and other countries.
 All other company and product names are trademarks or registered trademarks of their respective owners.

PRECAUTIONS

IMPORTANT

- To ensure personal safety and proper maintenance, please read this section and the caution statements on the unit (refer to the figure below).

[Location of Caution Statement]

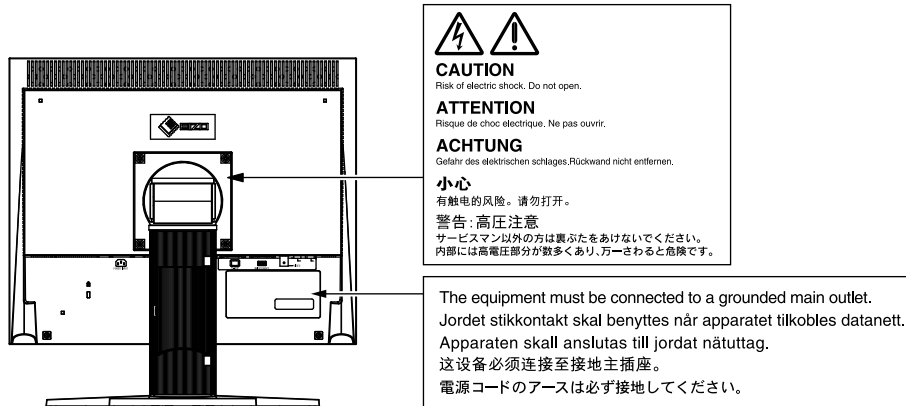

WARNING

If the unit begins to emit smoke, smells like something is burning, or makes strange noises, disconnect all power connections immediately and contact your dealer for advice.

Attempting to use a malfunctioning unit may result in fire, electric shock, or equipment damage.

Do not open the cabinet or modify the unit.

Opening the cabinet or modifying the unit may result in fire, electric shock, or burn.



Refer all servicing to qualified service personnel.

Do not attempt to service this product yourself as opening or removing covers may result in fire, electric shock, or equipment damage.

Keep small objects or liquids away from the unit.

Small objects accidentally falling through the ventilation slots into the cabinet or spillage into the cabinet may result in fire, electric shock, or equipment damage. If an object or liquid falls/spills into the cabinet, unplug the unit immediately. Have the unit checked by a qualified service engineer before using it again.



Place the unit at the strong and stable place.

A unit placed on an inadequate surface may fall and result in injury or equipment damage. If the unit falls, disconnect the power immediately and ask your dealer for advice. Do not continue using a damaged unit. Using a damaged unit may result in fire or electric shock.



WARNING

Use the unit in an appropriate location.

Not doing so may result in fire, electric shock, or equipment damage.

- Do not place outdoors.
- Do not place in a transportation system (ship, aircraft, train, automobile, etc.) where it may be affected by strong vibration or shock.
- Do not place in a dusty or humid environment.
- Do not place in a location where water is splashed on the screen (bathroom, kitchen, etc.).
- Do not place in a location where the steam comes directly on the screen.
- Do not place near heat generating devices or a humidifier.
- Do not place in a location where the product is subject to direct sunlight.
- Do not place in an inflammable gas environment.



To avoid danger of suffocation, keep the plastic packing bags away from babies and children.

Use the enclosed power cord and connect to the standard power outlet of your country.

Be sure to remain within the rated voltage of the power cord.

Not doing so may result in fire or electric shock.

Power supply: 100-120/200-240Vac 50/60Hz

To disconnect the power cord, grasp the plug firmly and pull.

Tugging on the cord may damage and result in fire or electric shock.



The equipment must be connected to a grounded main outlet.

Failure to do so may result in fire or electric shock.



Use the correct voltage.

- The unit is designed for use with a specific voltage only. Connection to another voltage than specified in this User's Manual may cause fire, electric shock, or equipment damage.

Power supply: 100-240Vac 50/60Hz

- Do not overload your power circuit, as this may result in fire or electric shock.

Handle the power cord with care.

- Do not place the cord underneath the unit or other heavy objects.
- Do not pull on or tie the cord.

If the power cord becomes damaged, stop using it. Use of a damaged cord may result in fire or electric shock.



Never touch the plug and power cord if it begins to thunder.

Touching them may result in electric shock.



When attaching an arm stand, please refer to the user's manual of the arm stand and install the unit securely.

Not doing so may cause the unit to become unattached, which may result in injury or equipment damage. When the unit is dropped, please ask your dealer for advice. Do not continue using a damaged unit. Using a damaged unit may result in fire or electric shock. When reattaching the tilt stand, please use the same screws and tighten them securely.

WARNING

Handle the batteries for the remote control with care.

Not doing so may result in battery explosion, liquid leakage, or burns.

- Do not disassemble, heat, short-circuit, or immerse the provided batteries in water.
 - Install/change batteries in a correct way.
 - When replacing batteries, use ones of the same type and model.
 - When replacing batteries, replace all of them at the same time with new batteries of the same brand and type.
 - Insert batteries with correct direction of the plus (+) and minus (-) sides.
 - Do not use the battery with coating damaged.
 - Dispose of your battery in a designated disposal area.
-

Keep the batteries for the remote control away from babies and children.

Accidental swallowing of the batteries may cause choking or poisoning.

In the event the batteries are swallowed, immediately consult a physician.

Do not touch a damaged LCD panel directly with bare hands.

The liquid crystal that may leak from the panel is poisonous if it enters the eyes or mouth. If any part of the skin or body comes in direct contact with the panel, please wash thoroughly. If some physical symptoms result, please consult your doctor.



Fluorescent backlight lamps contain mercury (the products that have LED backlight lamps contain no mercury), dispose according to local, state or federal laws.

CAUTION

Handle with care when carrying the unit.

Disconnect the power cord and cables when moving the unit. Moving the unit with the cord attached is dangerous. It may result in injury.

When handling the unit, grip the bottom of the unit firmly with both hands ensuring the panel faces outward before lifting.

Dropping the unit may result in injury or equipment damage.

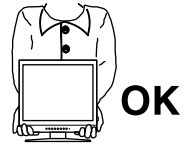

Do not block the ventilation slots on the cabinet.

- Do not place any objects on the ventilation slots.
- Do not install the unit in a closed space.
- Do not use the unit laid down or upside down.

Blocking the ventilation slots prevents proper airflow and may result in fire, electric shock, or equipment damage.



Do not touch the plug with wet hands.

Doing so may result in electrical shock.



Use an easily accessible power outlet.

This will ensure that you can disconnect the power quickly in case of a problem.

Periodically clean the area around the plug.

Dust, water, or oil on the plug may result in fire.

Unplug the unit before cleaning it.

Cleaning the unit while it is plugged into a power outlet may result in electric shock.

If you plan to leave the unit unused for an extended period, disconnect the power cord from the wall socket after turning off the power for safety and power conservation.

Notice for this monitor

This product is suited for displaying surveillance camera images.

This product has been adjusted specifically for use in the region to which it was originally shipped. If the product is used outside the region, it may not operate as specified in the specifications.

This product may not be covered by warranty for uses other than those described in this manual.

The specifications noted in this manual are only applicable when the following are used:

- Power cords provided with the product
 - Signal cables specified by us
-

Only use optional products manufactured or specified by us with this product.

As it takes about 30 minutes for the performance of electrical parts to stabilize, adjust the monitor 30 minutes or more after the monitor power has been turned on.

Monitors should be set to a lower brightness to reduce changes in luminosity caused by long-term use and maintain a stable display.

When the screen image is changed after displaying the same image for extended periods of time, an afterimage may appear. Use the screen saver or power save function to avoid displaying the same image for extended periods of time.

Periodic cleaning is recommended to keep the monitor looking new and to prolong its operation lifetime (refer to “Cleaning” (page 8)).

The LCD panel is manufactured using high-precision technology. Although, missing pixels or lit pixels may appear on the LCD panel, this is not a malfunction. Percentage of effective dots: 99.99% or higher.

The backlight of the LCD panel has a fixed lifetime. When the screen becomes dark or begins to flicker, please contact your local EIZO representative.

Do not press on the panel or edge of the frame strongly, as this may result in display malfunctions, such as interference patterns, etc. If pressure is continually applied to the panel, it may deteriorate or damage your panel. (If the pressure marks remain on the panel, leave the monitor with a black or white screen. The symptom may disappear.)

Do not scratch or press on the panel with any sharp objects, as this may result in damage to the panel. Do not attempt to brush with tissues as this may scratch the panel.

When the monitor is cold and brought into a room or the room temperature goes up quickly, dew condensation may occur on the interior and exterior surfaces of the monitor. In that case, do not turn the monitor on. Instead wait until the dew condensation disappears, otherwise it may cause some damage to the monitor.

Cleaning

ATTENTION

- Chemicals such as alcohol and antiseptic solution may cause gloss variation, tarnishing, and fading of the cabinet or panel, and also quality deterioration of the image.
 - Never use any thinner, benzene, wax, and abrasive cleaner, which may damage the cabinet or panel.
-

NOTE

- The optional ScreenCleaner is recommended for cleaning the cabinet and panel surface.
-

If necessary, the stains on the cabinet and panel surface can be removed by moistening part of a soft cloth with water.

To use the monitor comfortably

- An excessively dark or bright screen may affect your eyes. Adjust the brightness of the monitor according to the environmental conditions.
- Staring at the monitor for a long time tires your eyes. Take a 10-minute rest every hour.

CONTENTS

Cover	1
⚠ PRECAUTIONS	3
Notice for this monitor	7
CONTENTS	9
Chapter 1 Introduction	10
1-1. Features	10
1-2. Package Contents	10
1-3. Controls and Functions	11
Chapter 2 Connecting Cables	13
2-1. Connection Procedures	13
● When used as a PC monitor	13
● When using video equipment	14
2-2. Adjusting the Screen Height and Angle	15
Chapter 3 Settings and Adjustments	16
3-1. Using Quick-OSD menu	16
3-2. Using OSD menu	18
Chapter 4 Troubleshooting	21
Chapter 5 Reference	22
5-1. How to Attach the Optional Arm	22
5-2. Specifications	23
5-3. Preset Timing	25
LIMITED WARRANTY	26

Chapter 1 Introduction

Thank you very much for choosing an EIZO color LCD monitor.

1-1. Features

- 19-inch screen
- SXGA (1280 × 1024) display compliant
- Analog signal support
 - PC signal: D-Sub mini 15-pin connector × 1
 - Horizontal scan frequency 24.8 kHz - 74.8 kHz
 - Vertical scan frequency 56.2 Hz - 75.1 Hz
 - Video signal: BNC connector × 1
 - Applicable Format NTSC, PAL, SECAM
- Video Aspect function
 - Alters the display range of the input image (overscan)
- Remote control enables easy operation, setting and adjustment of the monitor.

1-2. Package Contents

Check that all the following items are included in the packaging box. If any items are missing or damaged, contact your local dealer.

NOTE

- Please retain the packing materials for future transport of the monitor.
-

- LCD Monitor
- Remote control
- Coin lithium battery (CR2032)
- Power cord
- Mounting screws (M4 × 12mm 4pcs)
- User's Manual (Limited Warranty included)

1-3. Controls and Functions

Monitor

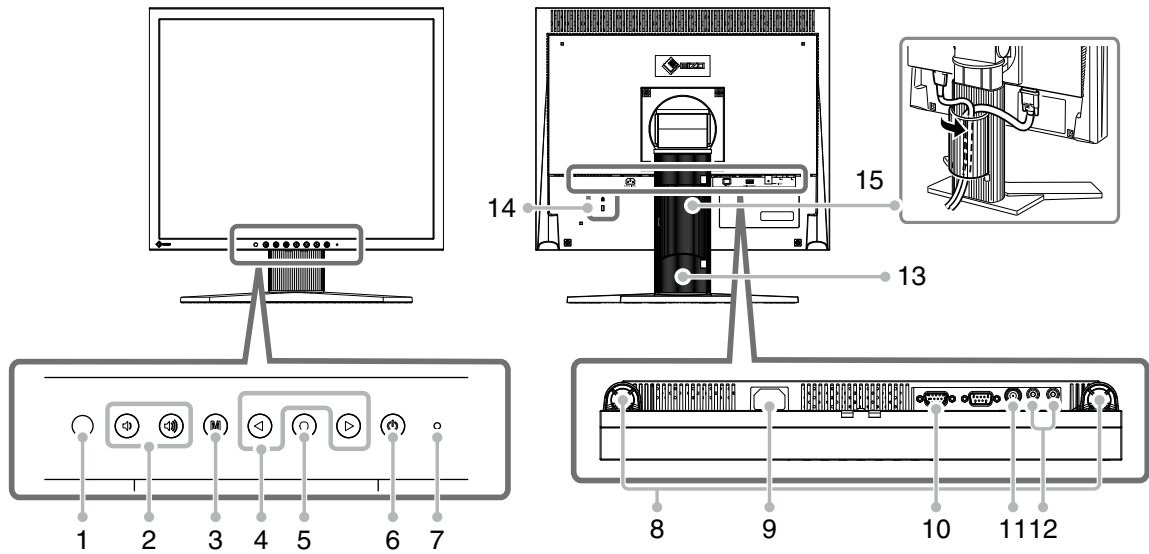

1	Remote control detector	Receives the signal from the remote control.
2	⏮⏭ button	Displays the volume adjustment menu to volume up or down.
3	Ⓜ button	<ul style="list-style-type: none"> Displays/Exits the OSD menu. Pressing the button while the OSD menu is displayed returns you to the previous menu status.
4	⏪⏩ button	<ul style="list-style-type: none"> Used to: select the OSD menu tab; select the set value; or to increase/decrease the adjustment value. Press ⏩ twice to switch the input signals.
5	Ⓞ button	<ul style="list-style-type: none"> Displays the Quick-OSD menu. Used to select the setting or adjustment items in each menu.
6	Ⓢ button	Turns the power on or off.
7	Power indicator	Indicates monitor's operation status. Blue : Operating Orange : Standby mode
8	Speaker	Outputs audio source.
9	Power connector	Connects the power cord.
10	Input signal connector	D-Sub mini 15-pin connector
11	Input signal connector	BNC connector
12	Input signal connector	Pin jack (L, R)
13	Stand*1	Used to adjust the height and angle of the monitor screen.
14	Security lock slot	Complies with Kensington's MicroSaver security system.
15	Cable holder	Covers the monitor cables.

*1 An optional arm (or an optional stand) can be attached by removing the stand (see "5-1. How to Attach the Optional Arm" (page 22)).

Remote Control

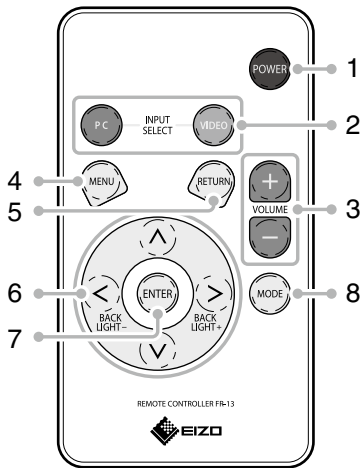

1	POWER	Turns the power on or off.	
2	INPUT SELECT	PC	Switches to PC input.
	VIDEO	Switches to video input.	
3	VOLUME	Displays the volume adjustment menu to volume up or down.	
4	MENU	<ul style="list-style-type: none"> Displays/Exits the OSD menu. Pressing the button while the OSD menu is displayed returns you to the previous menu status. 	
5	RETURN	Pressing the button while the menu is displayed returns you to the previous menu status.	
6	Navigation arrows	<ul style="list-style-type: none"> Used to: select the OSD menu tab; select the set value; or to increase/decrease the adjustment value. Pressing \leftarrow or \rightarrow while the OSD menu is not displayed allows you to adjust the brightness of the backlight. 	
7	ENTER	Used to fix the setting or adjustment items in each menu.	
8	MODE	Switches the gamma setting.	

Before Using Remote Control

● How to install batteries

1 While pushing the tab toward the arrow (1), pull out the battery case (2).

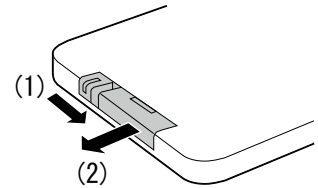

2 Insert a battery with the positive side up. (Battery model number: CR2032)

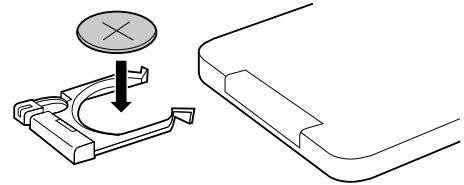

3 Insert the battery case until it clicks.

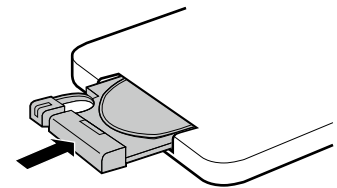

● Receivable Range of Remote Control

Use the remote control inside of the range as below.

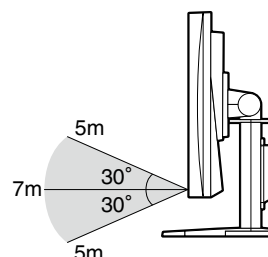
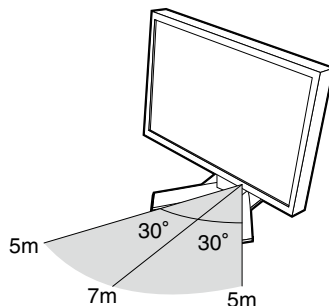

Chapter 2 Connecting Cables

2-1. Connection Procedures

1 Connects to external equipment compatible with the monitor.

- When used as a PC monitor page 13
- When using video equipment..... page 14

● When used as a PC monitor

ATTENTION

- When replacing the current monitor with an FDS1901 monitor, be sure to change the PC settings for the resolution and vertical scan frequency to those which are available for the FDS1901 monitor referring to the resolution table (see below) before connecting the PC.

Compatible Resolutions/Frequencies

The monitor supports the following resolutions.

Resolution	Display Mode	Vertical Scan Frequency	Dot Clock
640 × 400	NEC PC-9801	56 Hz	~126 MHz
640 × 400	NEC PC-9821 AP2	70 Hz	
640 × 480	Apple Macintosh	67 Hz	
640 × 480	VGA, VESA	~75 Hz	
720 × 400	VGA TEXT	70 Hz	
800 × 600	VESA	~75 Hz	
832 × 624	Apple Macintosh	75 Hz	
1024 × 768	VESA	~75 Hz	
1152 × 864	VESA	75 Hz	
1152 × 870	Apple Macintosh	75 Hz	
1280 × 960	VESA	60 Hz	
1280 × 960	Apple Macintosh	75 Hz	
1280 × 1024 ^{*1}	VESA	60 Hz	

*1 Recommended resolution

- Connect the monitor to the PC with a signal cable that matches the connectors.
After connecting the cable connectors, tighten the screws of the connectors to secure the coupling.

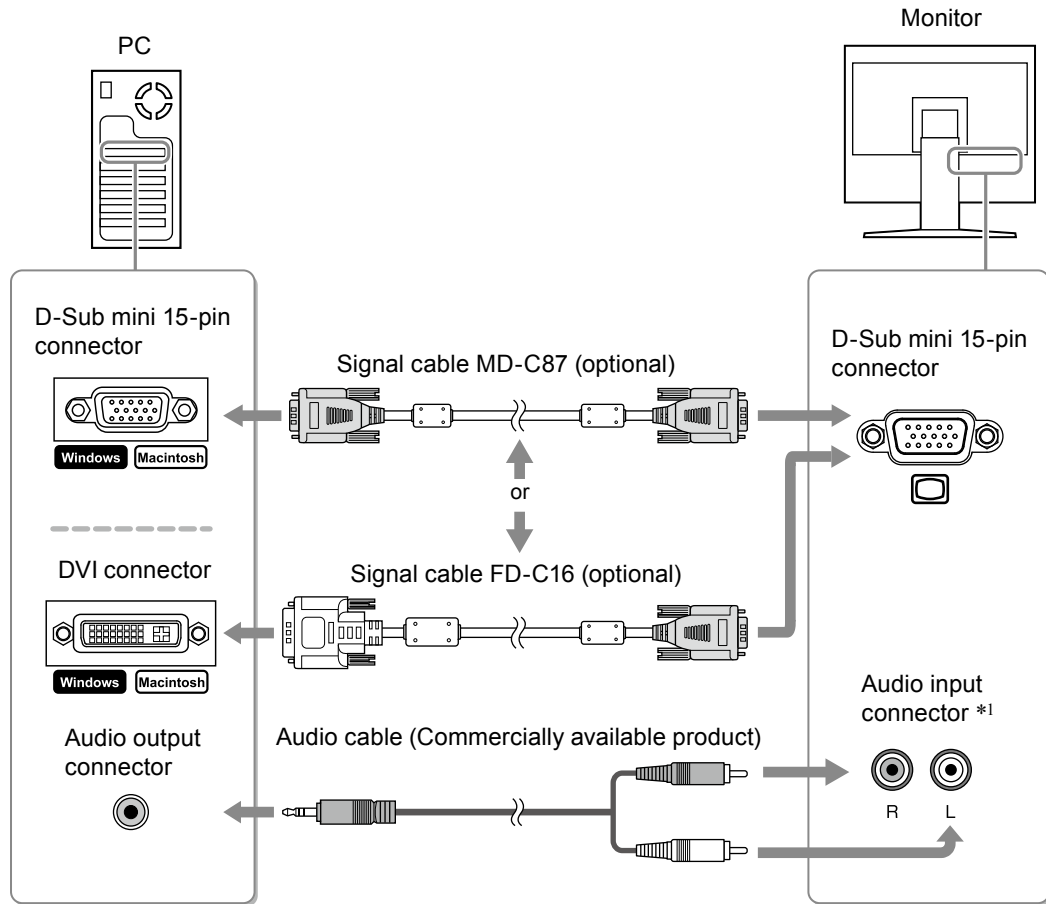

● When using video equipment

- Connect the monitor to the video equipment with a signal cable that matches the connectors.

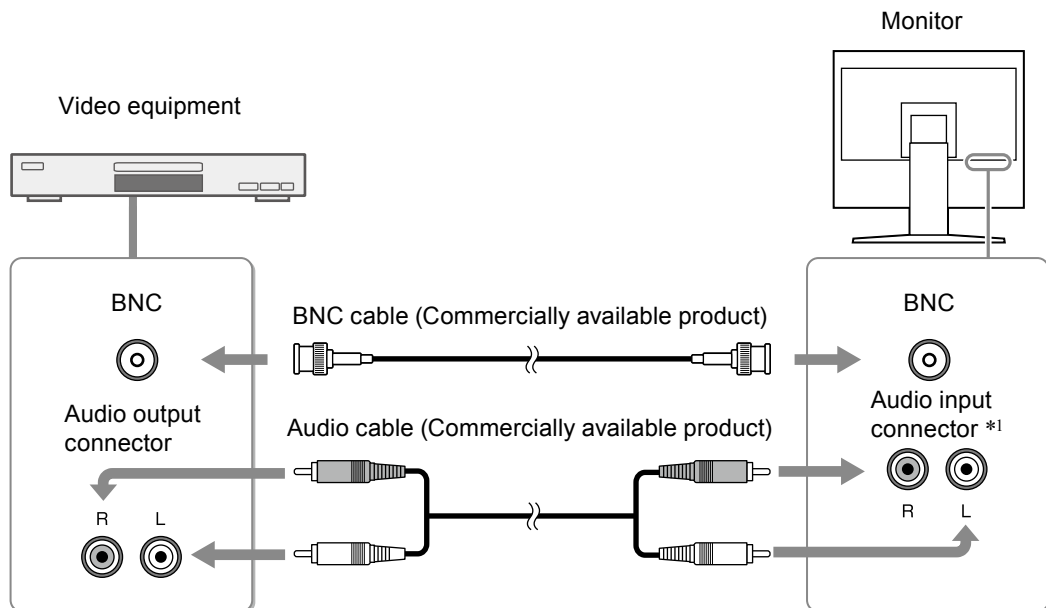

*1 The monitor is equipped with a single audio input connector to connect for either a PC or visual equipment. Regardless of the input device selected, the monitor will output sound.

2 Plug the power cord of the monitor into a power outlet.

Plug the power cord into a power outlet and the Power connector on the monitor.

ATTENTION

- For the maximum power saving, it is recommended that the Power button be turned off. Unplugging the power cord completely shuts off power supply to the monitor.

2-2. Adjusting the Screen Height and Angle

Hold left and right edge of the monitor with both hands, and adjust the screen height, tilt and swivel the screen to the best condition for working.

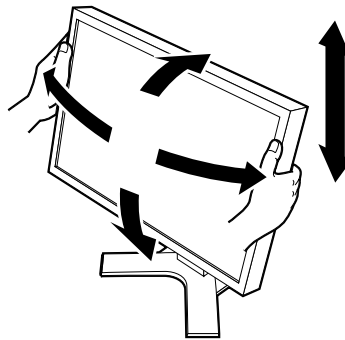

Chapter 3 Settings and Adjustments

Setting and adjustment of the monitor can be performed using the Quick-OSD menu or OSD menu.
The Quick-OSD menu enables easy operation of frequently used functions in the OSD menu.

3-1. Using Quick-OSD menu

Basic operation of Quick-OSD menu

1 Displaying Quick-OSD Menu

- **The buttons on the monitor**

Press .

- **The remote control**





Press , , or .

2 Setting/Adjusting

- **The buttons on the monitor**

Use  to select the set/adjustment items. Then, use  or  for setting/adjustment.

- **The remote control**

Use  or  to select the set/adjustment items. Then, use  or  for setting/adjustment.

3 Storing/Exiting

- **The buttons on the monitor**

The setting/adjustment is saved at the time it is changed.

The Quick-OSD menu automatically closes when a button is not used for 5 seconds.

- **The remote control**



The setting/adjustment is saved at the time it is changed.

Selecting  closes the Quick-OSD menu.



Functions

The adjustable settings in the Quick-OSD menu are shown below. The availability of items depends on the input signal.

√ : Configurable — : Not configurable

Setting / adjustable item		PC	Video	Setting / adjustable content
Brightness	0 to 100	√	√	Adjusts the brightness.
Contrast	0 to 100	√	√	Adjusts the contrast.
H Position	0 to 100	√	—	Adjusts the display position (horizontal).
V Position	0 to 100	√	—	Adjusts the display position (vertical).
Color	0 to 100	—	√	Adjusts the saturation.
Tint	0 to 100	—	√	Adjusts the hue.
Image Size	Fill All/16:9/4:3	—	√	Changes the screen size. * There are three sizes available for "16:9". The sizes switch in the following order:  →  →  .
Mode	Light/Dark/Dynamic	√	√	Switches the gamma setting.
Backlight	0 to 100	√	√	Adjusts the brightness of the backlight.

NOTE

- When a PC is used for input, the "Auto Adjust" (automatic screen adjustment) menu is displayed when the  and then  buttons are pressed. Press  while the menu is displayed to automatically adjust the screen.

3-2. Using OSD menu

Basic operation of OSD menu

1 Displaying OSD menu

- **The buttons on the monitor**



Press .



- **The remote control**

Press .



2 Setting/Adjusting





- **The buttons on the monitor**

Use  or  to select the menu tab and then press .

Use  to select the set/adjustment items. Then, use  or  for setting/adjustment.

- **The remote control**

Use  or  to select the menu tab and then press .

Use  or  to select the set/adjustment items. Then, use  or  for setting/adjustment.

3 Storing/Exiting

- **The buttons on the monitor**

After completing the setting/adjustment, selecting  allows you to store the setting.

Selecting  repeatedly closes the OSD menu.

- **The remote control**

After completing the setting/adjustment, selecting  allows you to store the setting.

Selecting  repeatedly closes the OSD menu.



NOTE

- To go back to the previous menu, press .
-

Functions

The settings adjustable in the OSD menu are as shown below. The availability of items depends on the input signal.

√ : Configurable — : Not configurable



Menu tab	Setting / adjustable item		PC	Video	Setting / adjustable content	
Picture	Brightness		0 to 100	√	√	Adjusts the brightness.
	Contrast		0 to 100	√	√	Adjusts the contrast.
	Phase		0 to 100	√	—	Adjusts the flickering or blurring.
	Frequency			√	—	Adjusts the frequency (clock).
	Sharpness		0 to 15	√	√	Adjusts the sharpness of the image outline. 0 (blur) to 15 (sharp) * This adjustment has no effect for images of 1280 × 1024 resolution.
	Color		0 to 100	—	√	Adjusts the saturation.
	Tint		0 to 100	—	√	Adjusts the hue.
	Color Temp	Red/ Green/ Blue	0 to 100	√	√	Adjusts the intensity of each color: Red, Green, and Blue.
Img. Adj	Image Size		Fill Aspect/ Fill All/ 1 TO 1	√	—	Changes the screen size.
			Fill All/ 16:9/4:3	—	√	Changes the screen size. * There are three sizes available for "16:9". The sizes switch in the following order:  →  →  .
	H Position		0 to 100	√	—	Adjusts the display position (horizontal).
	V Position		0 to 100	√	—	Adjusts the display position (vertical).
	Auto Adjust			√	—	Performs the automatic screen adjustment.

Menu tab	Setting / adjustable item		PC	Video	Setting / adjustable content	
Setup	Backlight		0 to 100	√	√	Adjusts the brightness of the backlight.
	DPMS		On/Off	√	√	Switches the power saving setting (DPMS) on or off. The backlight turns off when the synchronized input signal is no longer detected.
	OSD Settings	Transparency	0 to 100	√	√	Adjusts the transparency of the background color for the OSD menu.
		OSD Timeout (sec)	15 to 60	√	√	Adjusts the display time of the OSD menu.
	Mode		Light/Dark/Dynamic	√	√	Sets the appearance of the monitor to light, dark, or modulated screen that emphasizes low gradation contrast by setting the gamma.
	Up View		On/Off	√	√	Switches to the most suitable gamma setting if the screen is to be viewed from below.
	Source Scan		On/Off	√	√	Switches the auto-selection of input signal (automatically detects the input signal and displays the screen accordingly) on or off.
	Analog RGB Calibration			√	—	Adjusts the color gradation. Input the signal data in accordance with the displayed message.
	Reset Calibration			√	—	Returns the color gradation to the default setting.
Video Aspect		Normal/100%	√	√	Switches the display range of the input image (overscan). * Select "100%" to display the input image almost in full. (Depending on the input signal, noise may appear around the peripheral portions of the screen image.)	
Utilities	Language		English/Deutsch	√	√	Selects the language (English/Deutsch) for the menu.
	Factory Reset			√	√	Returns the menu to the default setting.
	Testpattern			√	√	Displays the Testpattern.
Infos			√	√	Displays the monitor information. * The "Power On Time" and "Backlight On Time" are not always "0" due to factory inspection when you purchase the monitor.	

Chapter 4 Troubleshooting

If a problem still remains after applying the suggested remedies, contact your local dealer.

Common

Problems	Possible cause and remedy
1. No picture <ul style="list-style-type: none"> Power indicator does not light. 	<ul style="list-style-type: none"> Check whether the power cord is connected properly. If the problem persists, turn off the power, and then turn it on again a few minutes later. Press  on the remote control (or  on the monitor).
<ul style="list-style-type: none"> Power indicator lights orange. 	<ul style="list-style-type: none"> Operate the mouse or keyboard. Check whether the power of the connected device is turned on. Check whether the signal cable is connected properly. Switch the input signal.
<ul style="list-style-type: none"> Power indicator lights blue. 	<ul style="list-style-type: none"> Check whether the power of the connected device is turned on. Switch the input signal. Set each adjusting value in [Brightness] and [Contrast] to higher level. (see page 19)
2. The screen is too bright or too dark.	<ul style="list-style-type: none"> Adjust using [Brightness] or [Contrast]. (The LCD monitor backlight has a fixed life span. When the screen becomes dark or begins to flicker, contact your local dealer.) (see page 19)
3. No sound	<ul style="list-style-type: none"> Check whether the audio cable is connected properly. Check that the volume is not set to "0".
4. Green/red/blue/white dots or defective dots remain on the screen.	<ul style="list-style-type: none"> This is due to LCD panel characteristics and is not a failure.
5. Interference patterns or pressure marks remain on the screen.	<ul style="list-style-type: none"> Leave the monitor with a white or black screen. The symptom may disappear.
6. Afterimages appear.	<ul style="list-style-type: none"> Afterimages are particular to LCD monitors. Avoid displaying the same image for a long time. Use the screen saver or power save function to avoid displaying the same image for extended periods of time.

When displaying on a PC screen

Problems	Possible cause and remedy
1. Display position is incorrect.	<ul style="list-style-type: none"> Adjust image position using [H Position] or [V Position]. (see page 19)
2. Whole screen is flickering or blurring.	<ul style="list-style-type: none"> Adjust using [Phase]. (see page 19)

Chapter 5 Reference

5-1. How to Attach the Optional Arm

An optional arm (or an optional stand) can be attached by removing the stand section. Please refer to our web site for the corresponding optional arm (or optional stand). <http://www.eizo.com>

ATTENTION

- When attaching an arm or stand, follow the instructions of their user's manual.
- When using another manufacturer's arm or stand, confirm the following in advance and select one conforming to the VESA standard. Use the M4 × 12mm screws supplied with this monitor.
 - Clearance between the screw holes : 100mm × 100mm
 - Thickness of plate : 2.6mm
 - Strong enough to support weight of the monitor unit (except the stand) and attachments such as cables.
- When using an arm or stand, attach it to meet the following tilt angles of the monitor.
 - Up 60 degrees, down 45 degrees (horizontal display)
 - Up 45 degrees, down 45 degrees (vertical display, 90 degrees clockwise)
- Connect the cables after attaching an arm or a stand.
- Since the monitor and arm are so heavy, dropping them may result in injury or equipment damage.

[Attachment Procedure]

1 Lay the LCD monitor on a soft cloth spread over on a stable surface with the panel surface facing down.

2 Remove the stand.

Prepare a screwdriver. Unscrew the four screws securing the unit and the stand with the screwdriver.

3 Attach the monitor to the arm or stand.

Secure the monitor to the arm or stand using the screws specified in the user's manual of the arm or stand.

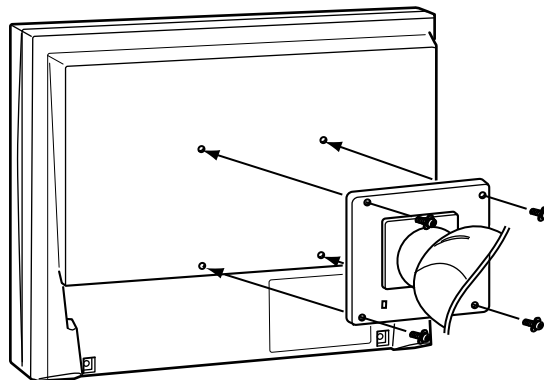

5-2. Specifications

LCD Panel	Size	19.0-inch (480 mm) TFT color LCD
	Surface treatment	Anti-glare
	Surface hardness	3H
	Viewing angle	Horizontal 170°, Vertical 170° (CR : 10 or more)
	Dot Pitch	0.294 mm
Display Area (H × V)		376.32 mm × 301.06 mm
Resolution		1280 dots × 1024 lines
Max. Display Color		Approx. 16.77 million colors
PC input	Horizontal Scan Frequency	24.8-74.8 kHz
	Vertical Scan Frequency	56.2-75.1 Hz
	Max. Dot Clock	126 MHz
	Input Signal Connector	D-Sub mini 15-pin ×1
	Input Signal (Sync)	Separate, TTL, positive / negative
	Input Signal (Video)	Analog, Positive (0.7Vp-p/75Ω)
	Max. Video Signal Memory	15 types
	Plug and Play	VESA DDC 2B / EDID structure 1.3
Video input	Applicable Format	NTSC, PAL, SECAM
	Input Signal Connector	BNC ×1
	Input Signal Level	1.0Vp-p/75Ω
Audio	Input Signal Connector	Pin Jack (L, R) ×1
	Speaker output	0.3 W + 0.3 W
Power Supply		100-120 VAC ±10%, 50/60 Hz 0.8 A 200-240 VAC ±10%, 50/60 Hz 0.5 A
Power Consumption	Screen Display On	49 W or less (Speaker working) 46 W or less (Speaker not working)
	Power saving mode	8 W or less (for single signal input, when audio cable is not connected)
	Power off	1.3 W or less
Dimensions (Width) × (Height) × (Depth)	Main unit	405 mm (15.9 inch) × 406.5 - 506.5 mm (16 - 19.9 inch) × 205 mm (8.1 inch)
	Main unit (without stand)	405 mm (15.9 inch) × 334 mm (13.1 inch) × 61.5 mm (2.42 inch)
Mass	Main unit	Approx. 7.2 kg (15.9 lbs.)
	Main unit (without stand)	Approx. 5.2 kg (11.5 lbs.)
Movable range	Tilt	30°Up, 0°Down
	Swivel	35°Right, 35°Left
Environmental Conditions	Temperature	Operating temperature : 0 °C - 35 °C (32 °F - 95 °F) Storage temperature : -20 °C - 60 °C (-4 °F - 140 °F)
	Humidity	Operating humidity : 20% - 80% R.H. (no condensation) Storage humidity : 10% - 90% R.H. (no condensation)
	Pressure	Operating : 700 hPa - 1,060 hPa Storage : 200 hPa - 1,060 hPa

Main default settings (factory settings)

Function		PC input	Video input
Volume		45	
Brightness		50	
Contrast		50	40
Sharpness		7	
Image Size		Fill All	
Color		—	60
Tint		—	50
Backlight		100	
DPMS		On	
OSD Settings	Transparency	50	
	OSD Timeout	45	
Mode		Light	
Up View		Off	
Source Scan		On	
Video Aspect		Normal	
Language		English	

Outside Dimensions

unit : mm (inch)

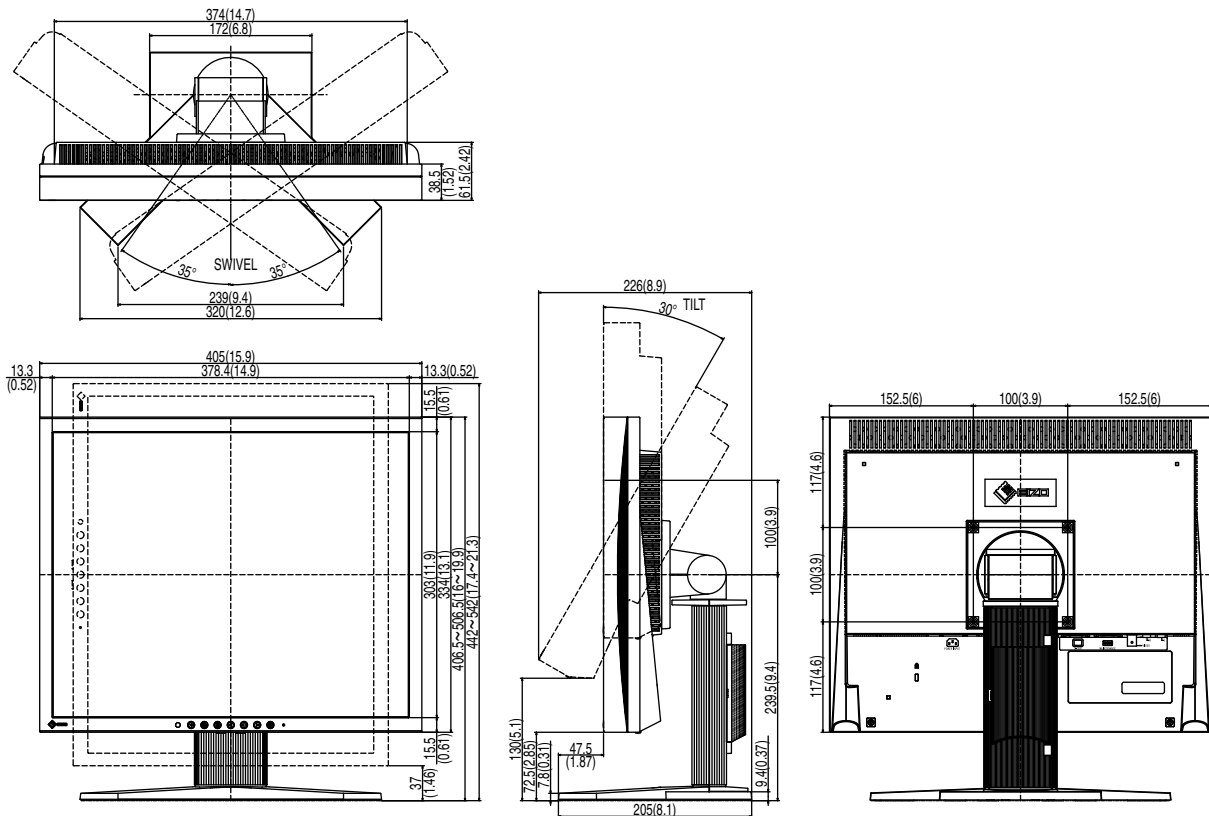

5-3. Preset Timing

The following table shows factory preset analog signal timing:

ATTENTION

- Display position may be deviated depending on the PC connected, which may require screen adjustment using Setting menu.
- If a signal other than those listed in the table is input, adjust the screen using the Setting menu. However, screen display may still be incorrect even after the adjustment.
- When interlace signals are used, the screen cannot be displayed correctly even after screen adjustment using the Setting menu.

Resolution	Applicable signal	Frequency			Polarity	
		Dot clock : MHz	Horizontal : kHz	Vertical : Hz	Horizontal	Vertical
720 × 400	VGA TEXT	28.33	31.47	70.09	Negative	Positive
640 × 480	VGA	25.18	31.47	59.94	Negative	Negative
640 × 480	VESA	31.5	37.86	72.81	Negative	Negative
640 × 480	VESA	31.5	37.50	75.00	Negative	Negative
800 × 600	VESA	36.00	35.16	56.25	Positive	Positive
800 × 600	VESA	40.00	37.88	60.32	Positive	Positive
800 × 600	VESA	50.00	48.08	72.19	Positive	Positive
800 × 600	VESA	49.50	46.88	75.00	Positive	Positive
1024 × 768	VESA	65.00	48.36	60.00	Negative	Negative
1024 × 768	VESA	75.00	56.48	70.07	Negative	Negative
1024 × 768	VESA	78.75	60.02	75.03	Positive	Positive
1152 × 864	VESA	108.00	67.50	75.00	Positive	Positive
1280 × 960	VESA	108.00	60.00	60.00	Positive	Positive
1280 × 1024	VESA	108.00	63.98	60.02	Positive	Positive
640 × 480	MAC	30.24	35.00	66.67	Negative	Negative
832 × 624	MAC	57.28	49.72	74.55	Negative	Negative
1152 × 870	MAC	100.00	68.68	75.06	Negative	Negative
1280 × 960	MAC	126.20	74.76	74.76	Positive	Positive
640 × 400	PC-9801	21.05	24.83	56.42	Negative	Negative
640 × 400	PC-9821 AP2	25.18	31.48	70.10	Negative	Negative

LIMITED WARRANTY

EIZO Corporation (hereinafter referred to as “EIZO”) and distributors authorized by EIZO (hereinafter referred to as the “Distributors”) warrant, subject to and in accordance with the terms of this limited warranty (hereinafter referred to as the “Warranty”), to the original purchaser (hereinafter referred to as the “Original Purchaser”) who purchased the product specified in this document (hereinafter referred to as the “Product”) from EIZO or Distributors, that EIZO and Distributors shall, at their sole discretion, either repair or replace the Product at no charge if the Original Purchaser becomes aware within the Warranty Period (defined below) that the Product malfunctions or is damaged in the course of normal use of the Product in accordance with the description in the instruction manual attached to the Product (hereinafter referred to as the “User’s Manual”).

The period of this Warranty is two (2) years from the date of purchase of the Product (hereinafter referred to as the “Warranty Period”). EIZO and Distributors shall bear no liability or obligation with regard to the Product in relation to the Original Purchaser or any third parties other than as provided under this Warranty.

EIZO and Distributors will cease to hold or store any parts of the Product upon expiration of seven (7) years after the production of such parts is discontinued. In repairing the monitor, EIZO and Distributors will use renewal parts which comply with our QC standards.

The Warranty is valid only in the countries or territories where the Distributors are located. The Warranty does not restrict any legal rights of the Original Purchaser.

Notwithstanding any other provision of this Warranty, EIZO and Distributors shall have no obligation under this Warranty whatsoever in any of the cases as set forth below:

- (a) Any defect of the Product caused by freight damage, modification, alteration, abuse, misuse, accident, incorrect installation, disaster, faulty maintenance and/or improper repair by third party other than EIZO and Distributors;
- (b) Any incompatibility of the Product due to possible technical innovations and/or regulations;
- (c) Any deterioration of the sensor;
- (d) Any deterioration of display performance caused by the deterioration of expendable parts such as the LCD panel and/or backlight, etc. (e.g. changes in brightness, changes in brightness uniformity, changes in color, changes in color uniformity, defects in pixels including burnt pixels, etc.);
- (e) Any defect of the Product caused by external equipment;
- (f) Any defect of the Product on which the original serial number has been altered or removed;
- (g) Any defect of the Product caused by liquid leaking from battery;
- (h) Any normal deterioration of the product, particularly that of consumables, accessories, and/or attachments (e.g. batteries, buttons, rotating parts, remote control, cables, User’s Manual, etc.); and
- (i) Any deformation, discoloration, and/or warp of the exterior of the product including that of the surface of the LCD panel.

To obtain service under the Warranty, the Original Purchaser must deliver the Product, freight prepaid, in its original package or other adequate package affording an equal degree of protection, assuming the risk of damage and/or loss in transit, to the local Distributor. The Original Purchaser must present proof of purchase of the Product and the date of such purchase when requesting services under the Warranty.

The Warranty Period for any replaced and/or repaired product under this Warranty shall expire at the end of the original Warranty Period.

EIZO OR DISTRIBUTORS ARE NOT RESPONSIBLE FOR ANY DAMAGE TO, OR LOSS OF, DATA OR OTHER INFORMATION STORED IN ANY MEDIA OR ANY PART OF ANY PRODUCT RETURNED TO EIZO OR DISTRIBUTORS FOR REPAIR.

EIZO AND DISTRIBUTORS MAKE NO FURTHER WARRANTIES, EXPRESSED OR IMPLIED, WITH RESPECT TO THE PRODUCT AND ITS QUALITY, PERFORMANCE, MERCHANTABILITY OR FITNESS FOR ANY PARTICULAR USE. IN NO EVENT SHALL EIZO OR DISTRIBUTORS BE LIABLE FOR ANY INCIDENTAL, INDIRECT, SPECIAL, CONSEQUENTIAL OR OTHER DAMAGE WHATSOEVER (INCLUDING, WITHOUT LIMITATION, DAMAGES FOR LOSS OF PROFIT, BUSINESS INTERRUPTION, LOSS OF BUSINESS INFORMATION, OR ANY OTHER PECUNIARY LOSS) ARISING OUT OF THE USE OR INABILITY TO USE THE PRODUCT OR IN ANY CONNECTION WITH THE PRODUCT, WHETHER BASED ON CONTRACT, TORT, NEGLIGENCE, STRICT LIABILITY OR OTHERWISE, EVEN IF EIZO OR DISTRIBUTORS HAVE BEEN ADVISED OF THE POSSIBILITY OF SUCH DAMAGES. THIS EXCLUSION ALSO INCLUDES ANY LIABILITY WHICH MAY ARISE OUT OF THIRD PARTY CLAIMS AGAINST THE ORIGINAL PURCHASER. THE ESSENCE OF THIS PROVISION IS TO LIMIT THE POTENTIAL LIABILITY OF EIZO AND DISTRIBUTORS ARISING OUT OF THIS LIMITED WARRANTY AND/OR SALES.

关于电子信息产品污染控制标识



本标识根据「电子信息产品污染控制管理办法」，适用于在中华人民共和国销售的电子信息产品。标识中央的数字为环保使用期限的年数。只要您遵守该产品相关的安全及使用注意事项，在自制造日起算的年限内，不会产生对环境污染或人体及财产的影响。上述标识粘贴在机器背面。

• 有毒有害物质或元素的名称及含量

部件名称	有毒有害物质或元素					
	铅 (Pb)	汞 (Hg)	镉 (Cd)	六价铬 (Cr (VI))	多溴联苯 (PBB)	多溴二苯醚 (PBDE)
印刷电路板	×	○	○	○	○	○
机箱	○	○	○	○	○	○
液晶显示器	×	×	○	○	○	○
其他	×	○	○	○	○	○

○：表示该有毒有害物质在该部件所有均质材料中的含量均在 SJ/T 11363-2006 规定的限量要求以下。
 ×：表示该有毒有害物质至少在该部件的某一均质材料中的含量超出 SJ/T 11363-2006 规定的限量要求。
 （企业可在此处，根据实际情况对上表中打“×”的技术原因进行进一步说明）



EIZO Corporation

153 Shimokashiwano, Hakusan, Ishikawa 924-8566 Japan
Phone: +81 76 277 6792 Fax: +81 76 277 6793

EIZO Europe GmbH

Helmut-Grashoff-Strasse 18, 41179 Mönchengladbach, Germany
Phone: +49 2161 8210210 Fax: +49 2161 8210150

艺卓显像技术(苏州)有限公司

中国苏州市苏州工业园区展业路8号中新科技工业坊5B
Phone: +86 512 6252 0100 Fax: +86 512 6252 1508

<http://www.eizo.com>

Copyright © 2010-2013 EIZO Corporation All rights reserved.

4th Edition-April, 2013 Printed in Japan.

00NOL652D1
(U.M-FDS1901-EU)